

[54] GARDEN TOOL

[76] Inventor: Peter Haddad, 118 Taylor St., Titusville, Fla. 32780

[**] Term: 14 Years

[21] Appl. No.: 966,102

[22] Filed: Dec. 4, 1978

[51] Int. Cl. D8-01

[52] U.S. Cl. D8/09; D8/11; D8/45

[58] Field of Search 15/235.4, 235.3; D8/45, D8/5, 11, 13, 9; 172/371, 380, 375, 378; 294/50.6, 51, 57, 55.5

[56] References Cited

U.S. PATENT DOCUMENTS

307,981 11/1884 Peace D8/45
3,592,272 7/1971 Perez 294/51

3,942,591 3/1976 Brannin 172/375
3,952,812 4/1976 Lucan 172/375
4,090,730 5/1978 Zeigler 294/50.6

Primary Examiner—Bernard Ansher

[57] CLAIM

The ornamental design for a garden tool, as shown and described.

DESCRIPTION

FIG. 1 is a side perspective view of a garden tool embodying my design, with both the serrated front end and the arcuate rear end being sharpened; FIG. 2 is a top view thereof, with a bottom view thereof being identical to FIG. 2 except that the handle in the center would not be visible; FIG. 3 is a left-side view thereof, with a right-side view being a mirror image thereof; FIG. 4 is a front view thereof; and FIG. 5 is a rear view thereof.

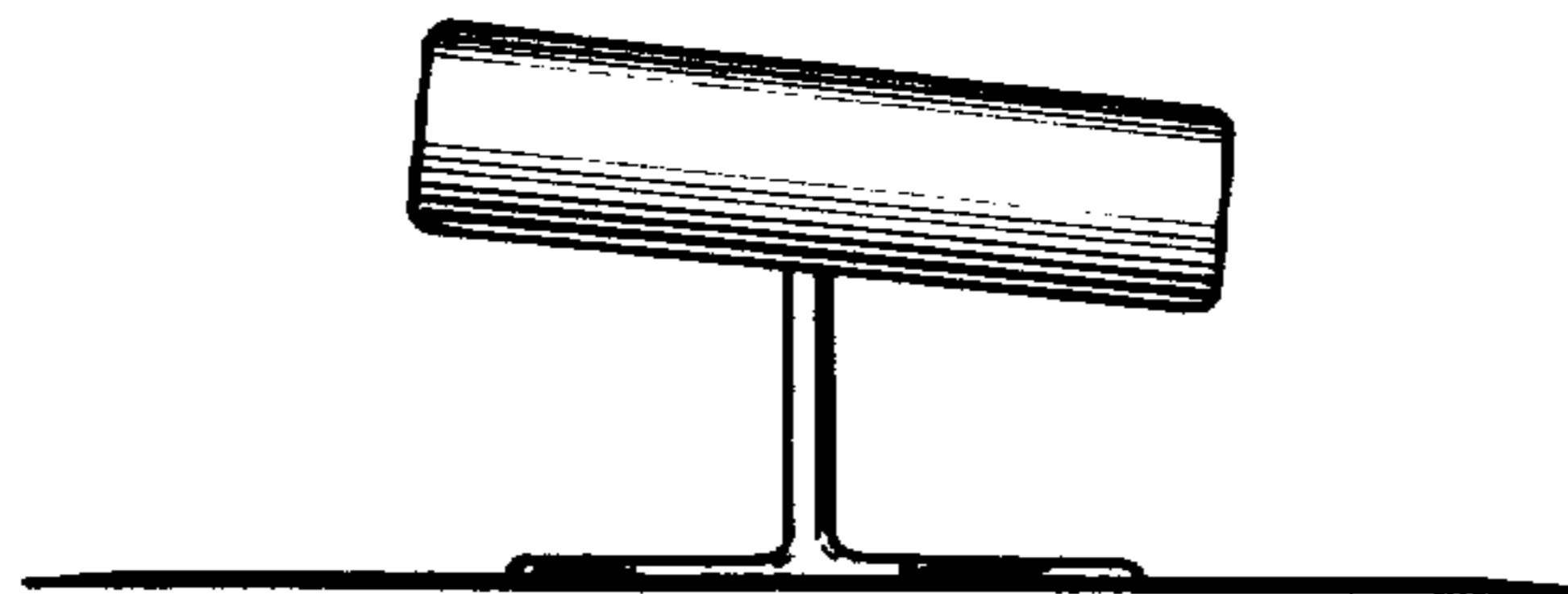
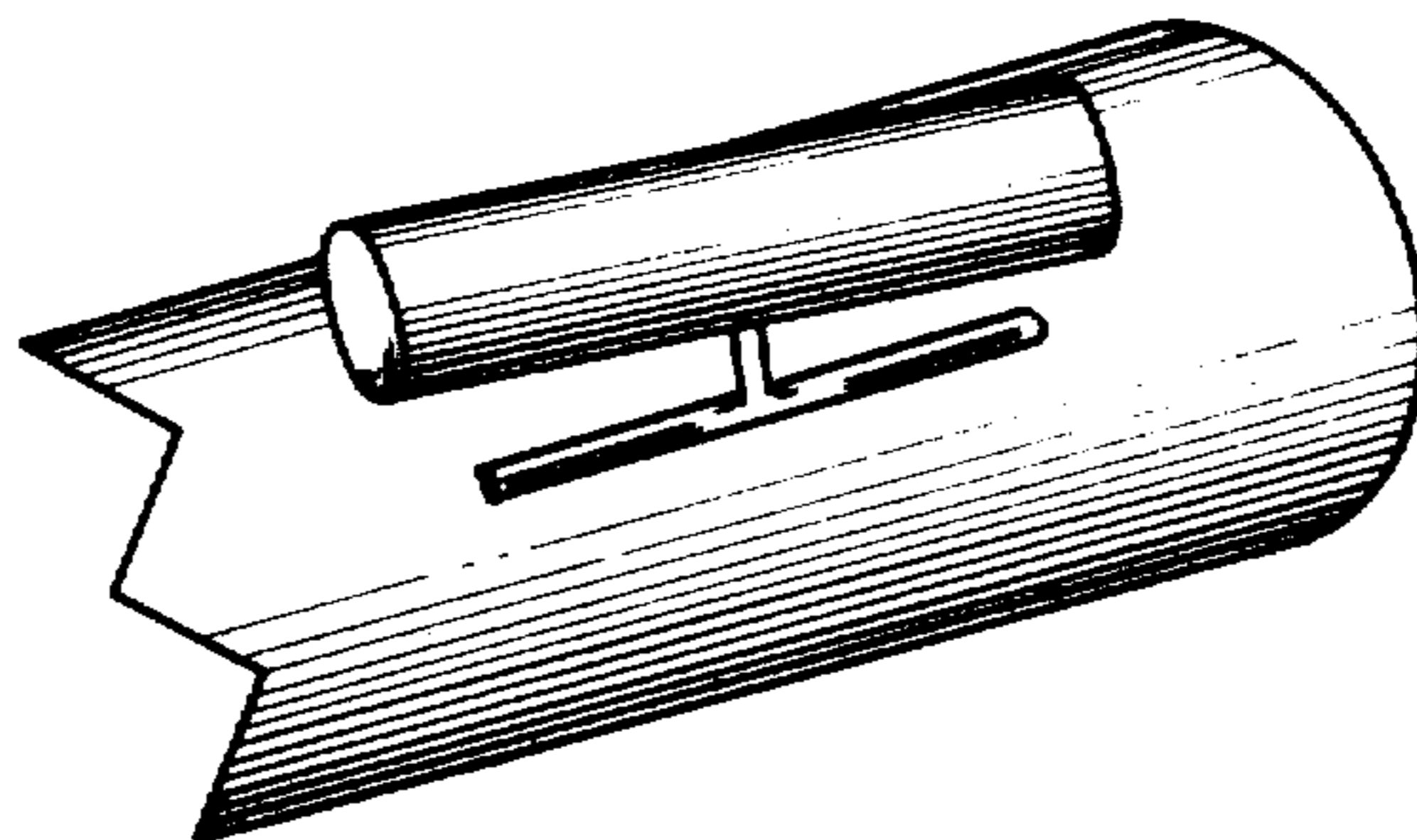

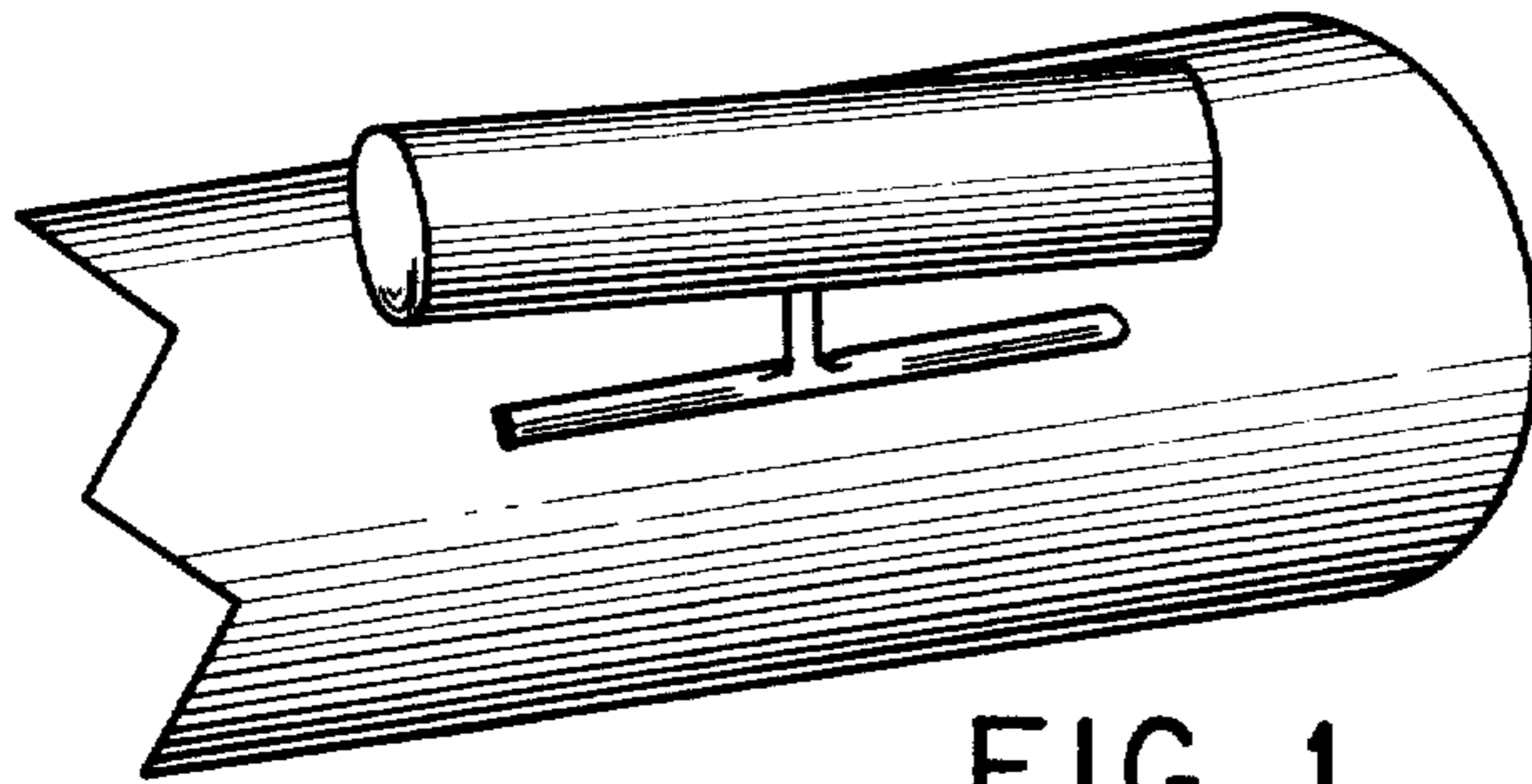

FIG. 1

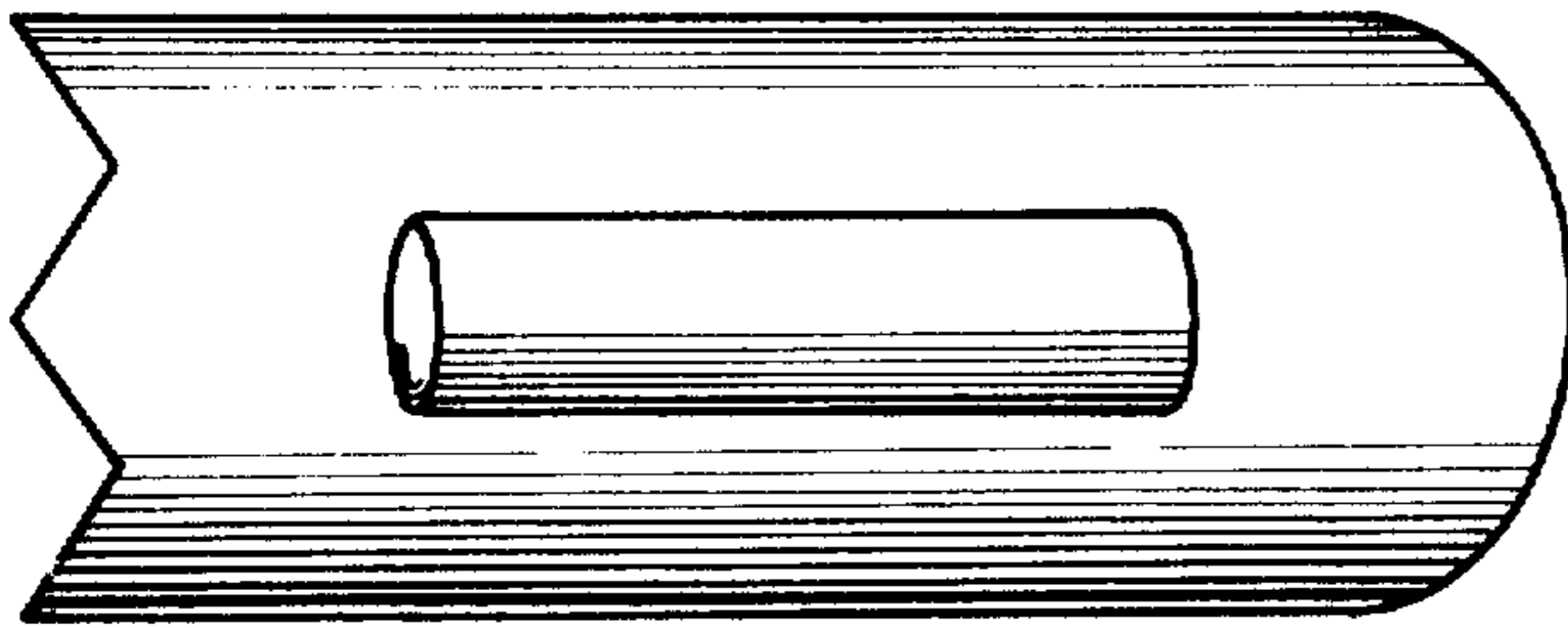

FIG. 2

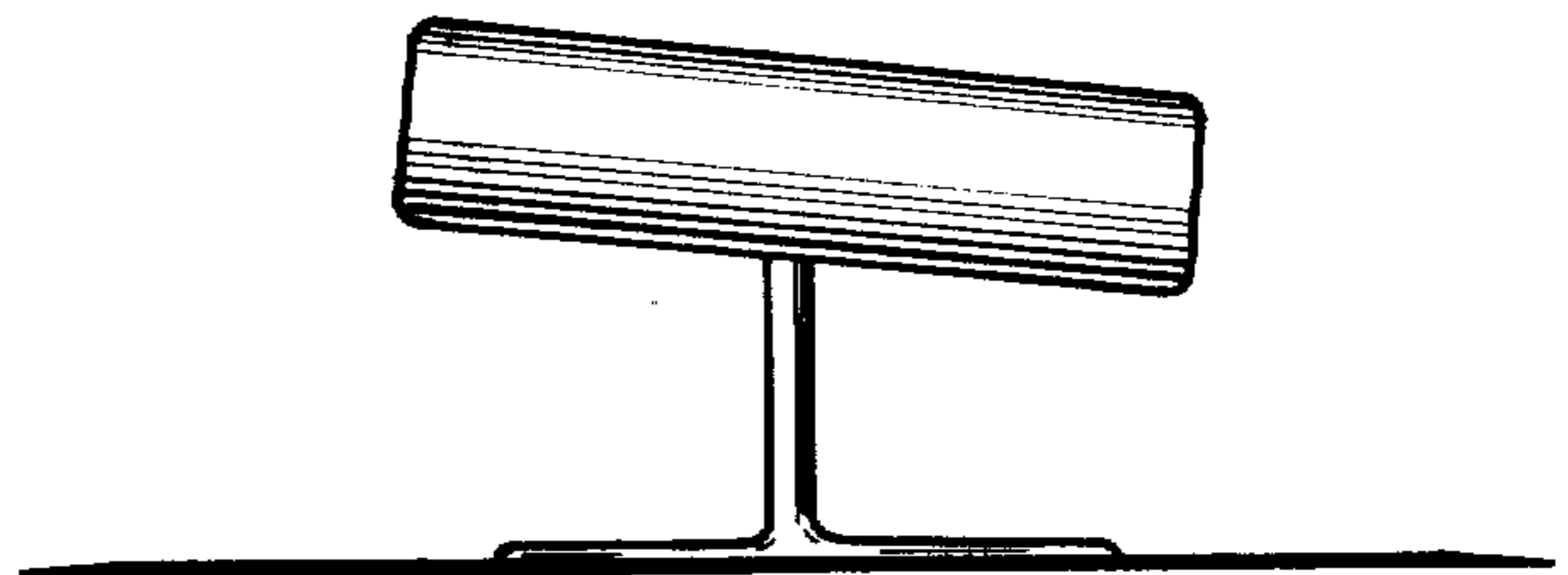

FIG. 3

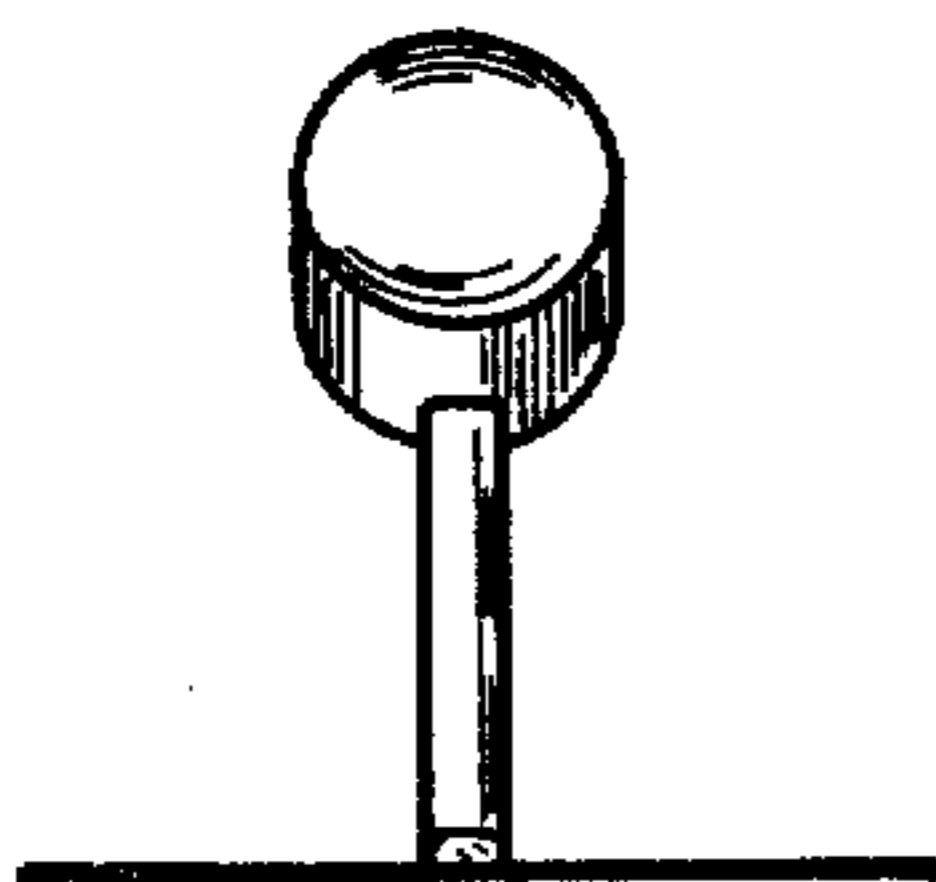

FIG. 4

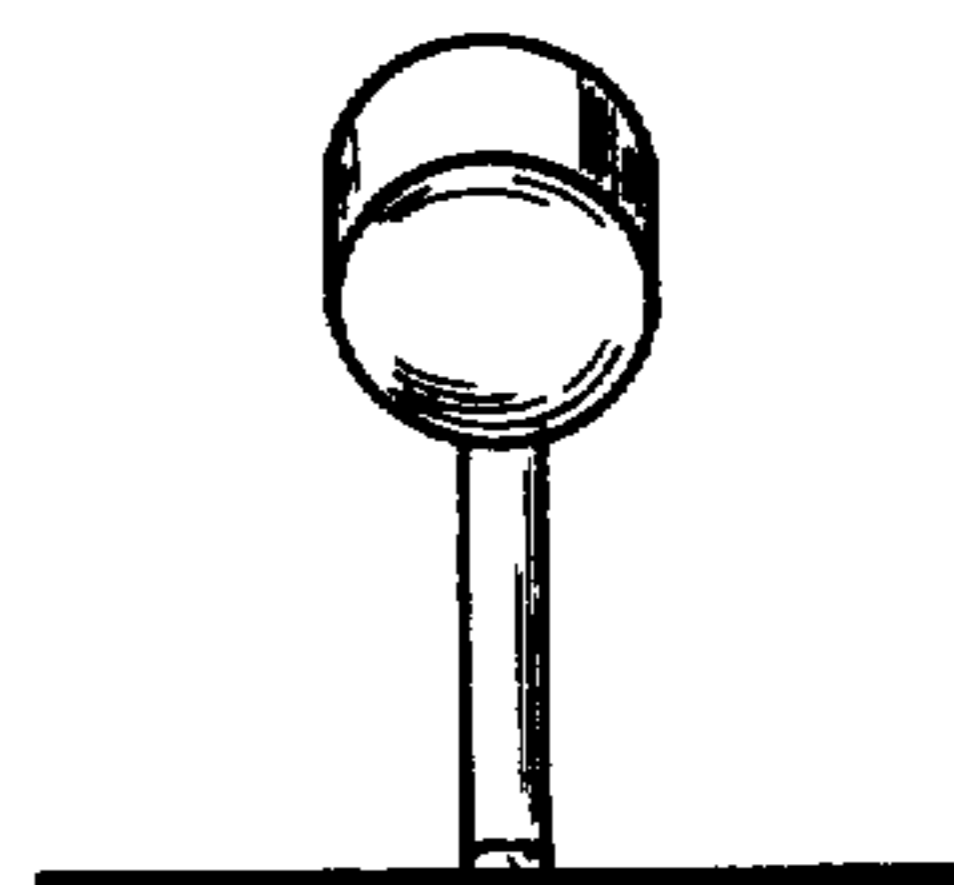

FIG. 5