

[54] **C.A.T.V. SIGNAL SPLITTER**
[75] **Inventor: David F. Shu, Cook County, Ill.**
[73] **Assignee: TDS, Inc., Elk Grove Village, Ill.**
[**] **Term: 14 Years**
[21] **Appl. No.: 37,404**
[22] **Filed: May 9, 1979**
[51] **Int. Cl. D13—02**
[52] **U.S. Cl. D13/11**
[58] **Field of Search D13/11, 13, 24, 32,**
D13/99; 339/124, 177 R; 358/68

[56] **References Cited**
U.S. PATENT DOCUMENTS
3,989,333 11/1976 Caldwell 339/177 R

OTHER PUBLICATIONS
Layfayette Cat. No. 690, 1969; p. 349, No. 3, center top
of page, Splitter Model SC 72-77.

Primary Examiner—Peter M. Caun
Attorney, Agent, or Firm—Howard C. Miskin

[57] **CLAIM**
The ornamental design for a C.A.T.V. signal splitter, as
shown and described.

DESCRIPTION
FIG. 1 is a front elevational view of a C.A.T.V. signal
splitter;
FIG. 2 is a right side elevational view thereof;
FIG. 3 is a top view thereof;
FIG. 4 is a left side elevational view thereof;
FIG. 5 is a bottom view thereof;
FIG. 6 is a rear elevational view thereof;
FIG. 7 is a perspective view of another embodiment, all
other views being the same as the first shown embodi-
ment;
FIG. 8 is a perspective view of a third embodiment, all
other views being the same as the first shown embodi-
ment.

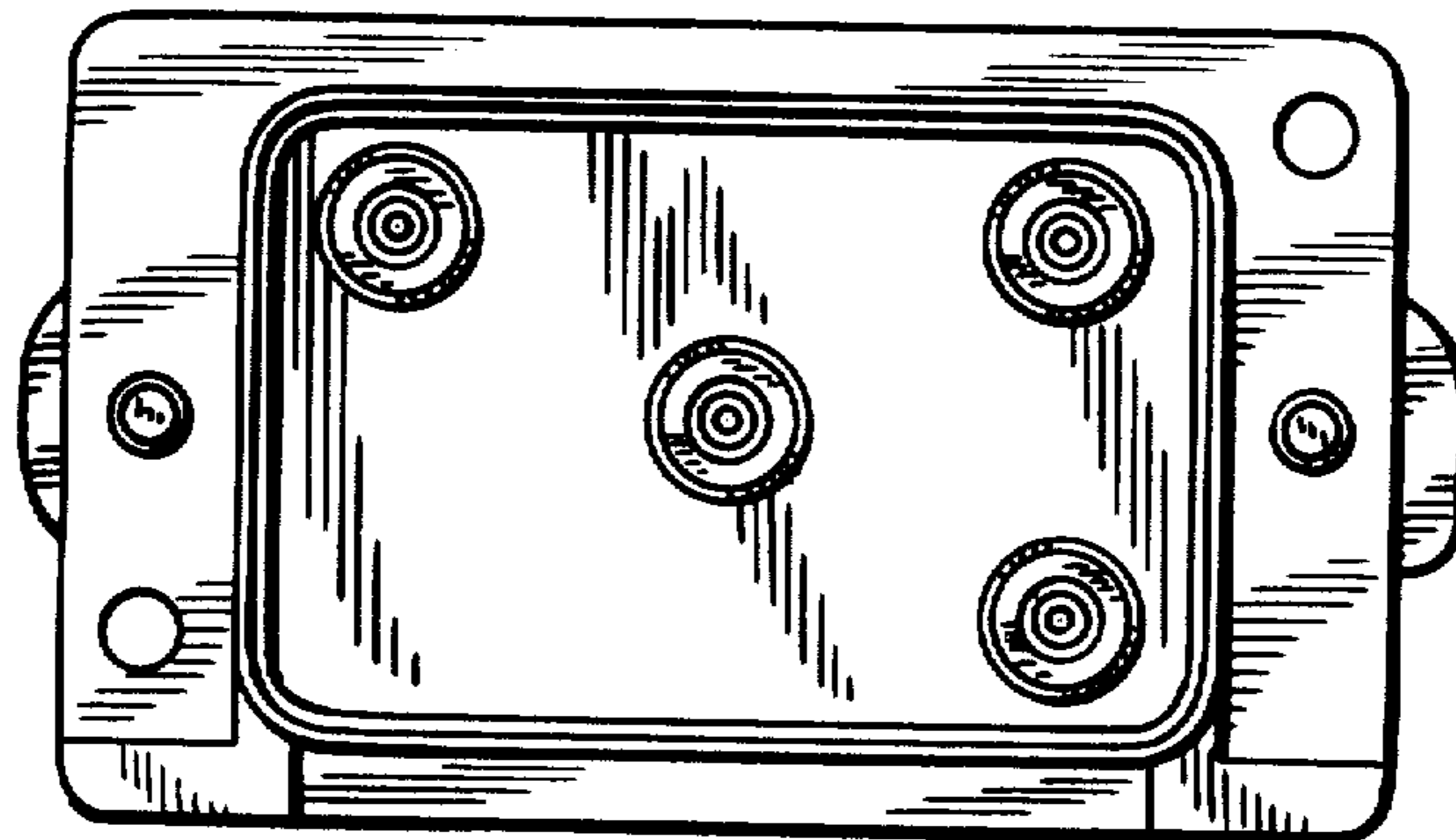

FIG. 1

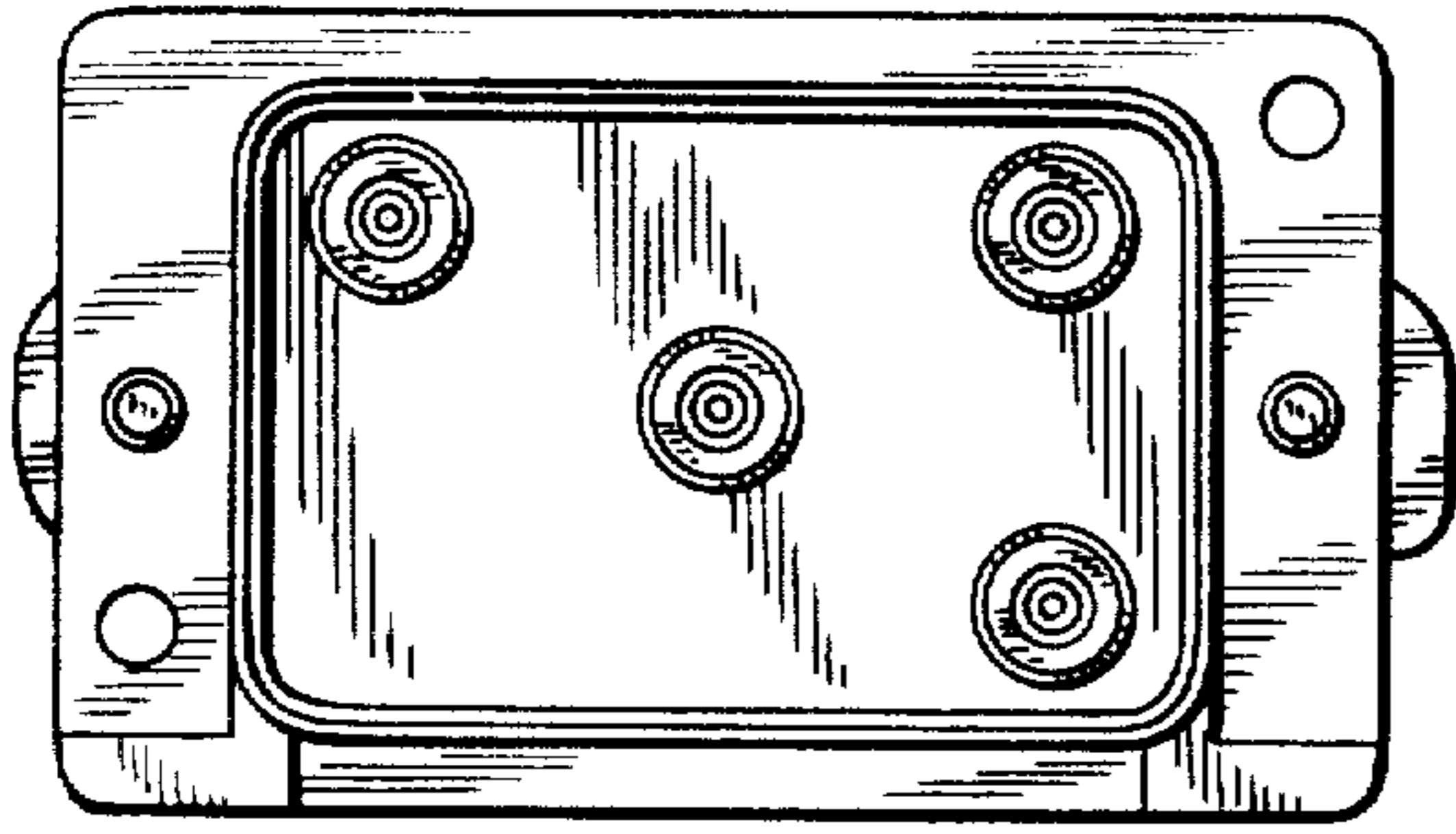

FIG. 2

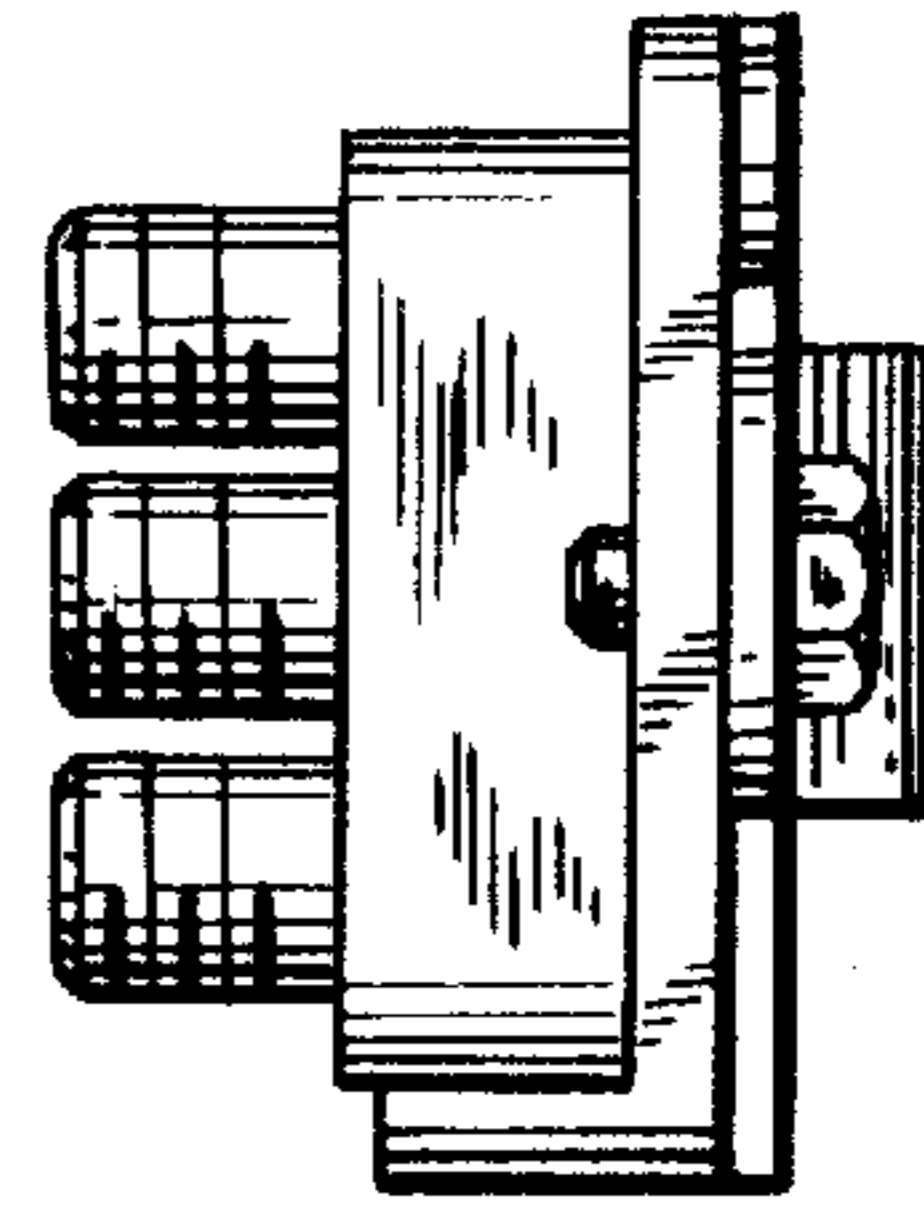

FIG. 3

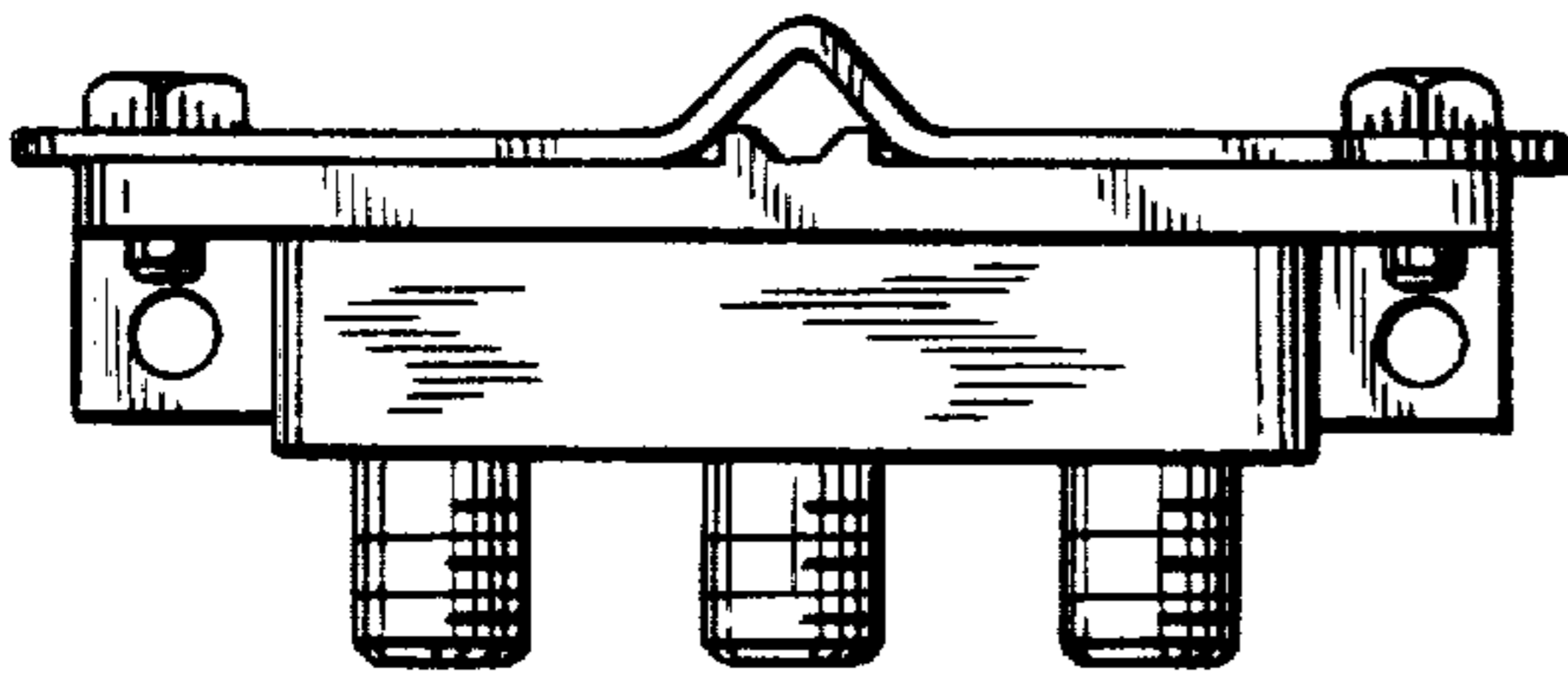

FIG. 4

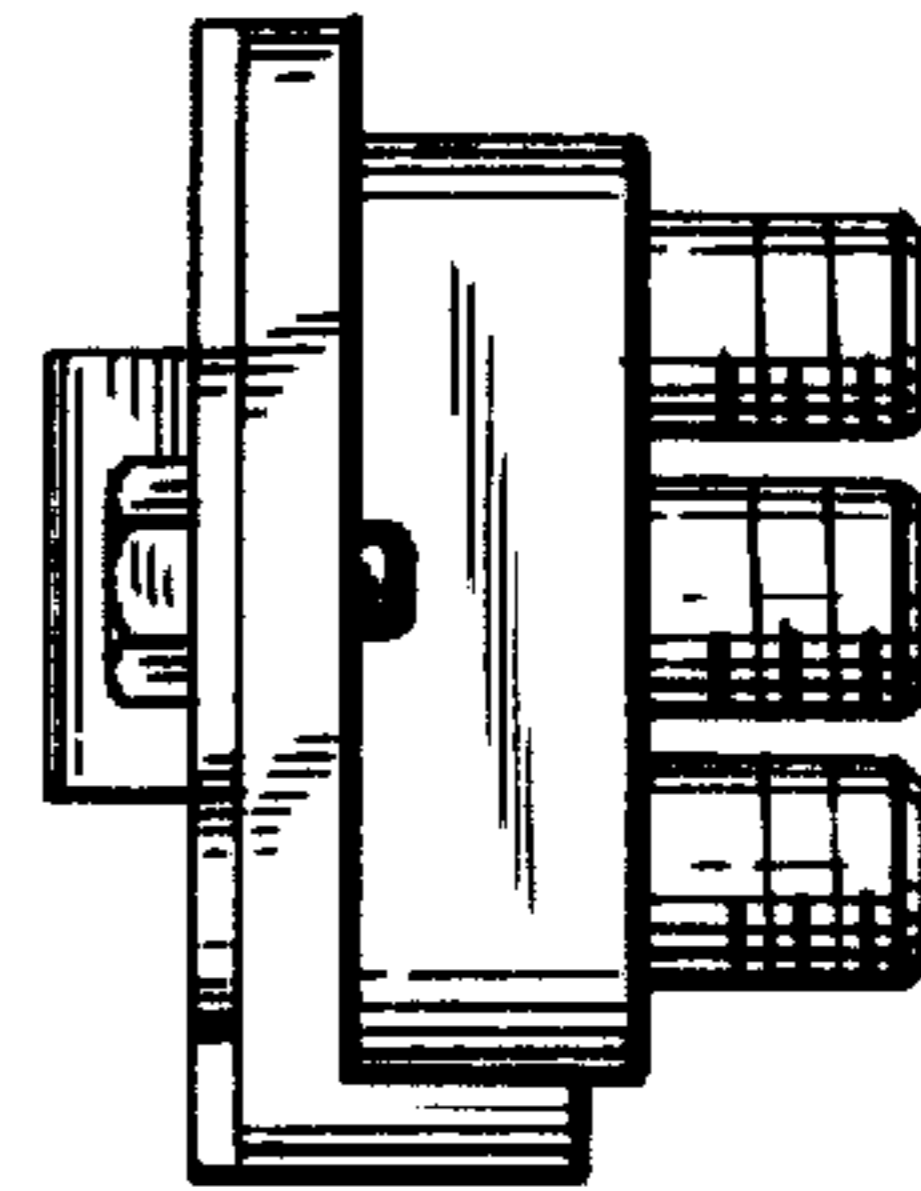

FIG. 5

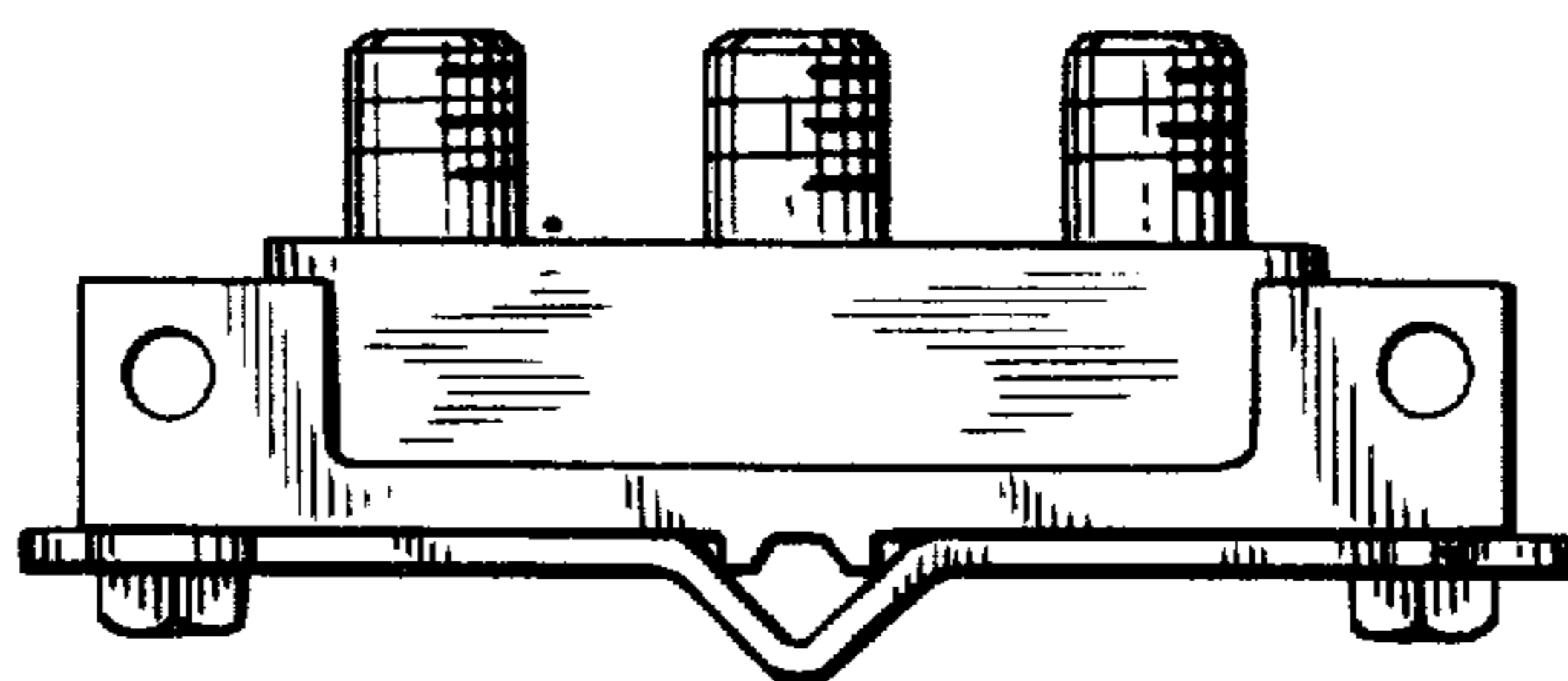

FIG. 6

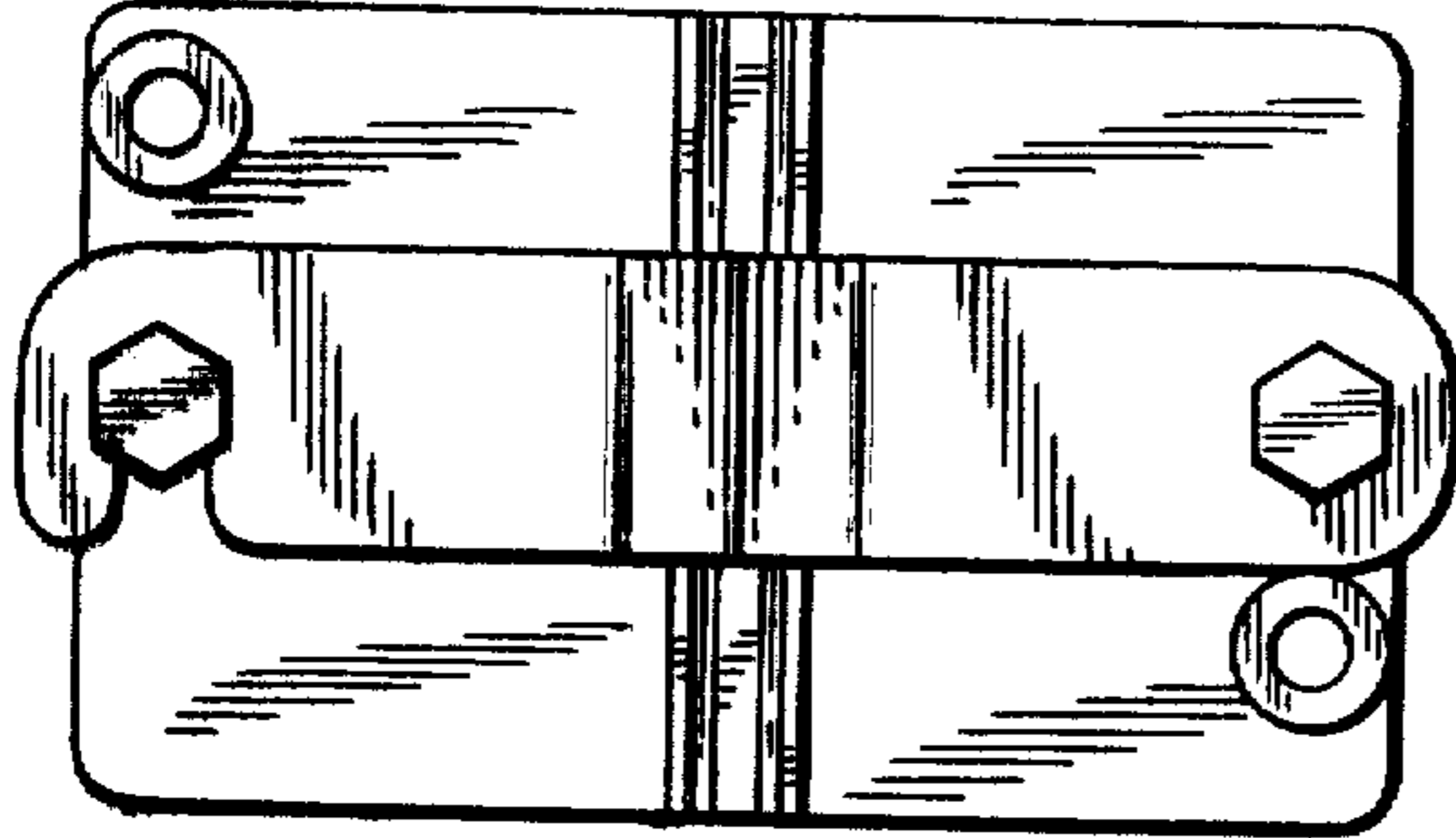

FIG. 7

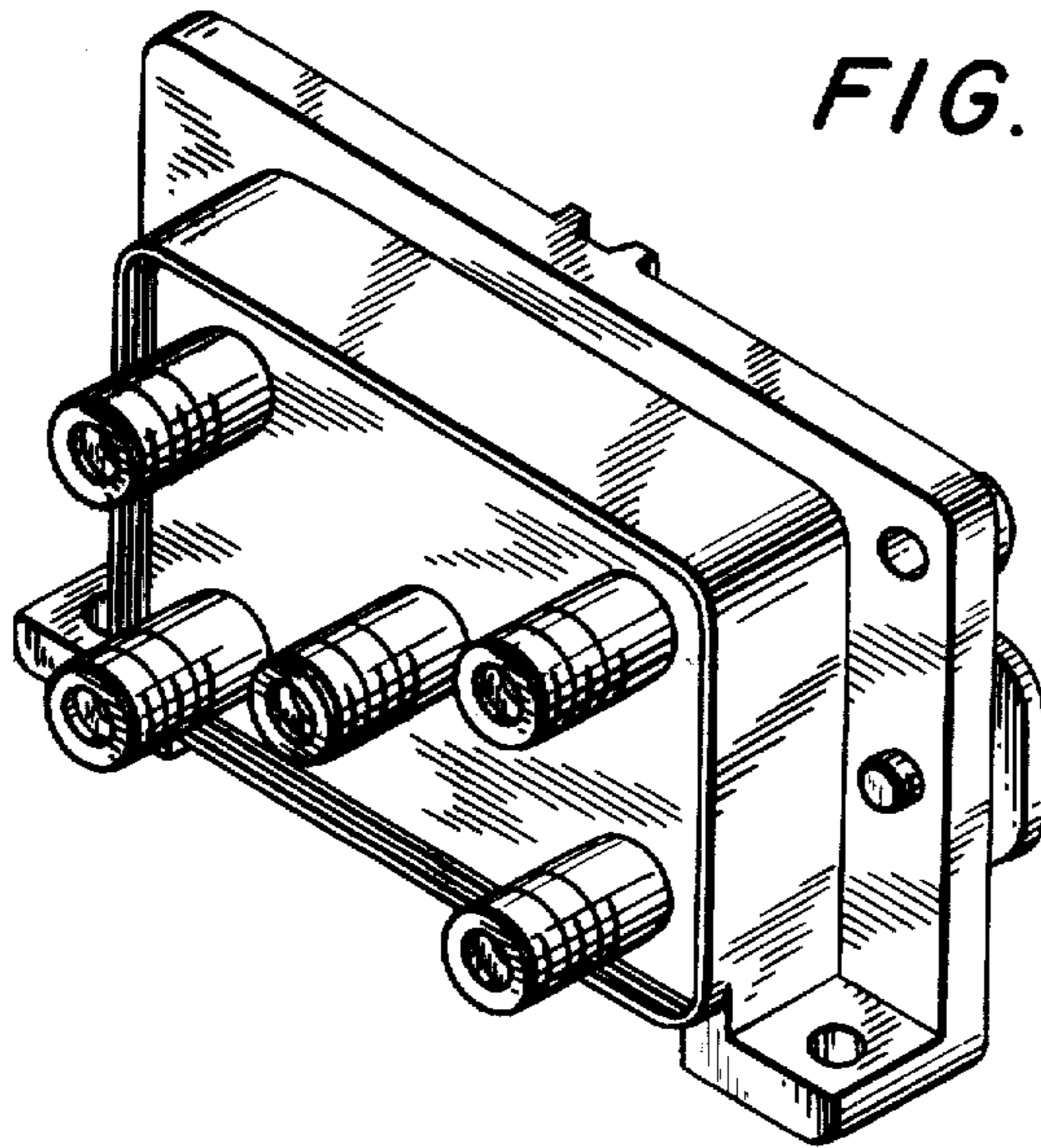

FIG. 8

