

[54] HYDROTHERAPY SPA  
[75] Inventors: **Ralph D'Innocente**, Pleasant Hill;  
**Richard L. Janosko**, Oakland, both of Calif.

D. 245,542 8/1977 Melcior ..... D24/38  
D. 247,577 3/1978 Digiacomo ..... D24/38  
3,297,025 1/1967 Jacuzzi ..... D24/38 X  
3,688,775 9/1972 Raymann ..... 128/366  
3,952,338 4/1976 Traxclair ..... 4/172.15

[73] Assignee: **Jacuzzi Whirlpool Bath, Inc.**, Walnut Creek, Calif.

*Primary Examiner*—Bernard Ansher

[\*\*] Term: **14 Years**

[57] **CLAIM**

The ornamental design for a hydrotherapy spa, as shown.

[21] Appl. No.: **5,404**

**DESCRIPTION**

[22] Filed: **Jan. 22, 1979**

[51] Int. Cl. .... **D24—01; D23—02**

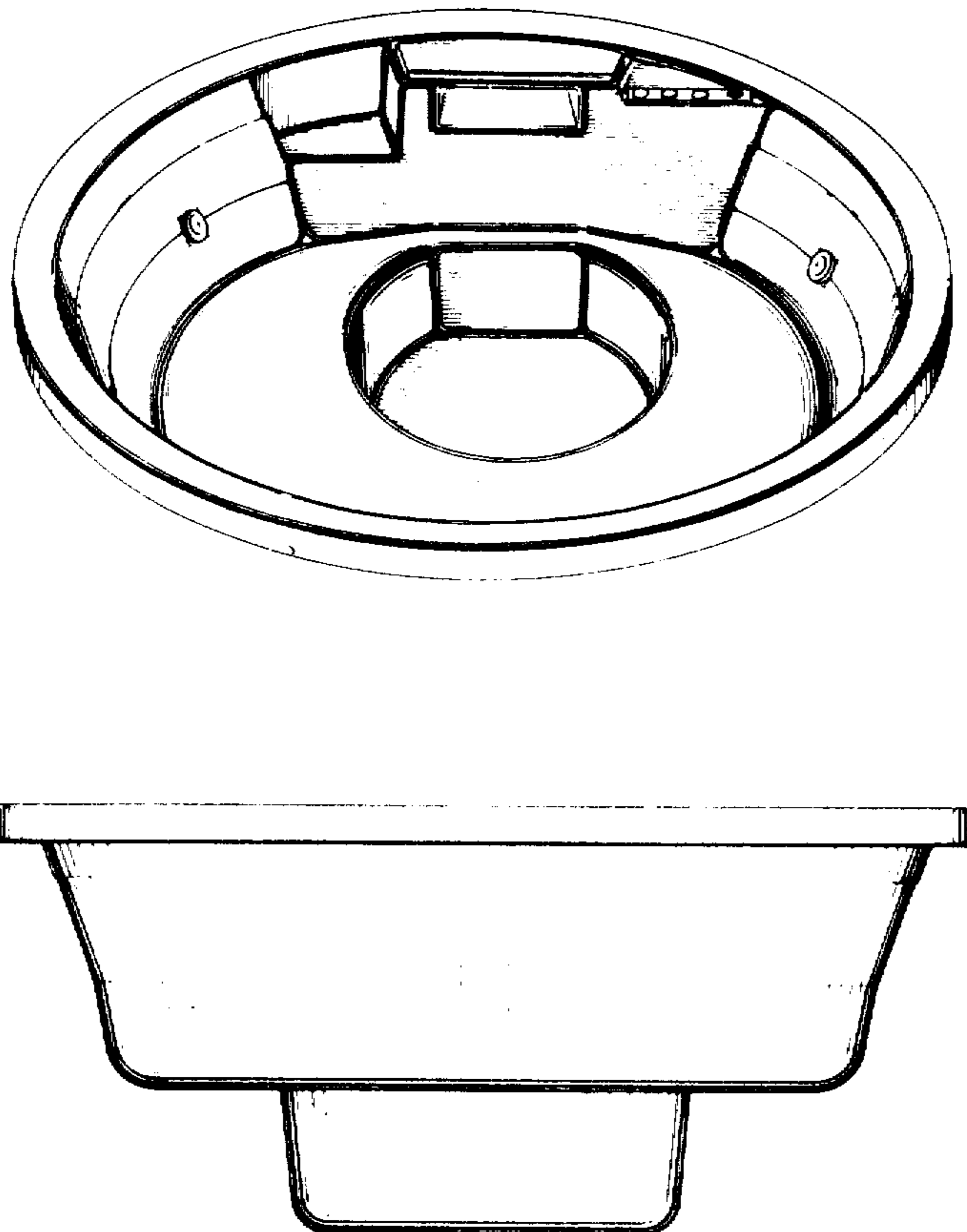
[52] U.S. Cl. .... **D24/38; D23/55; D25/2**

[58] Field of Search ..... **D24/38, 36; D23/55, D23/56; D25/2; 4/172, 173, 177, 162; 128/66, 366**

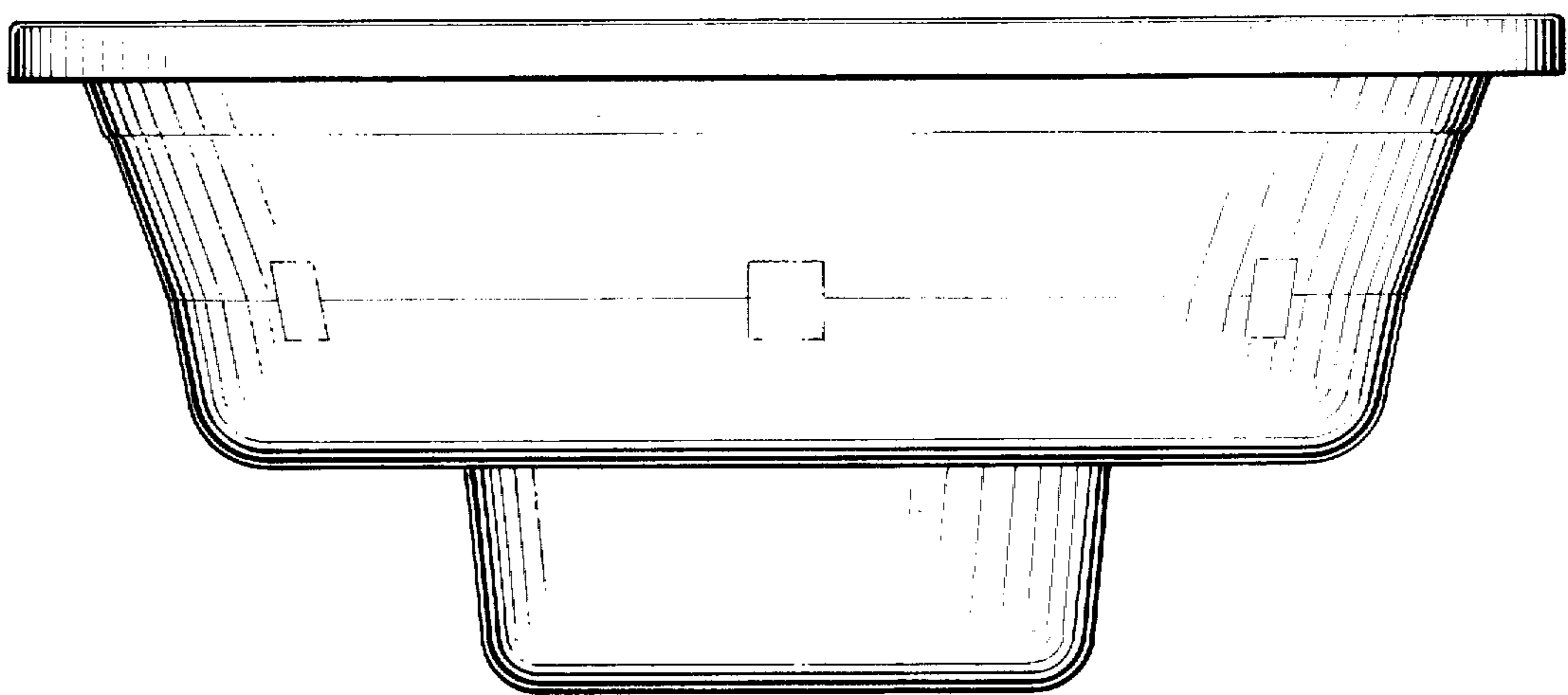
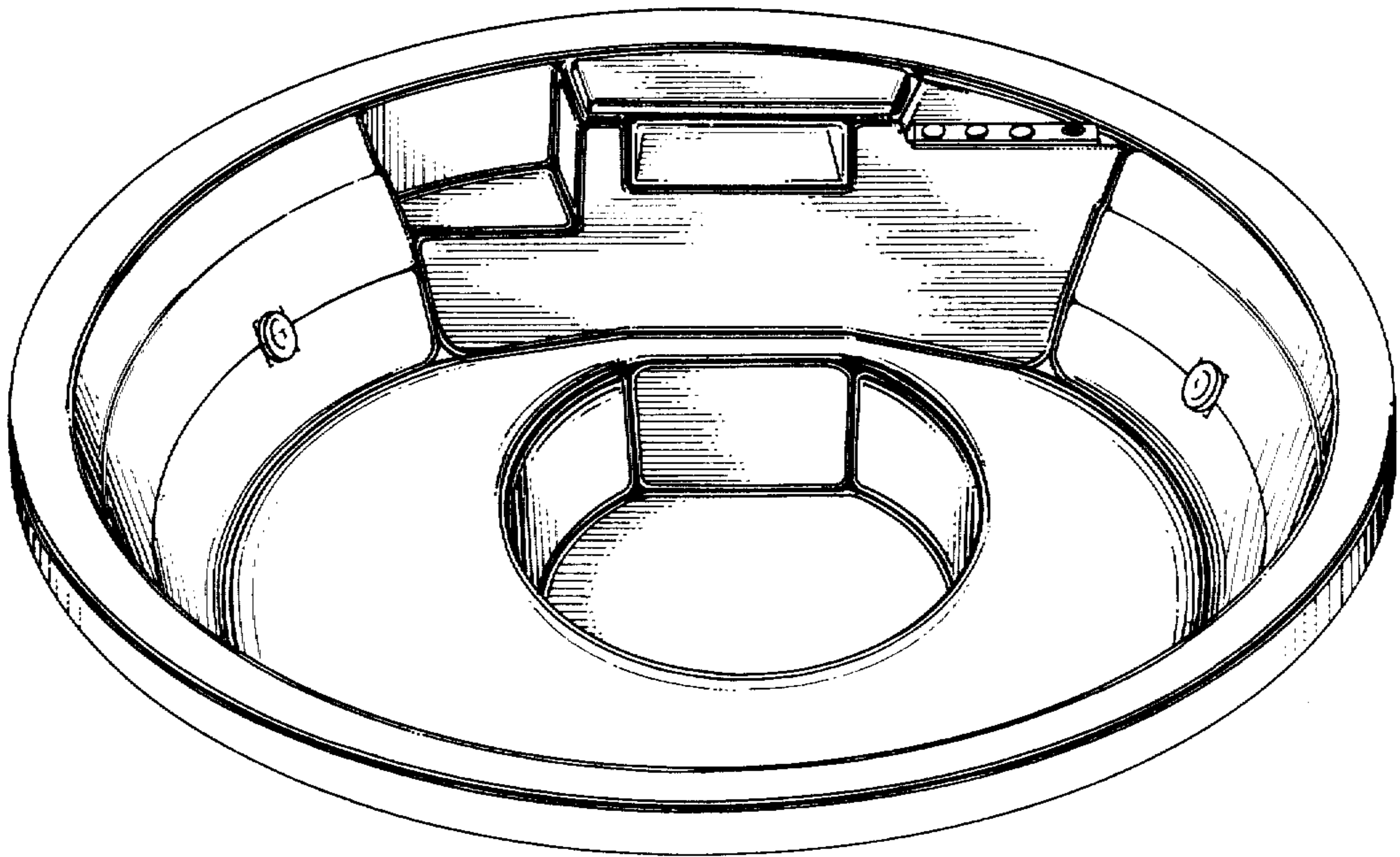
FIG. 1 is a top perspective view of a hydrotherapy spa showing our new design;  
FIG. 2 is a front elevational view of the hydrotherapy spa shown in FIG. 1;  
FIG. 3 is a top plan view of the hydrotherapy spa shown in FIG. 1;  
FIG. 4 is a cross-sectional view taken along the line 4—4 of FIG. 3;  
FIG. 5 is a left side elevational view of the hydrotherapy spa shown in FIG. 1; and  
FIG. 6 is a rear elevational view of the hydrotherapy spa shown in FIG. 1.

[56] **References Cited**  
**U.S. PATENT DOCUMENTS**

D. 206,143 11/1966 Jacuzzi ..... D24/36 X

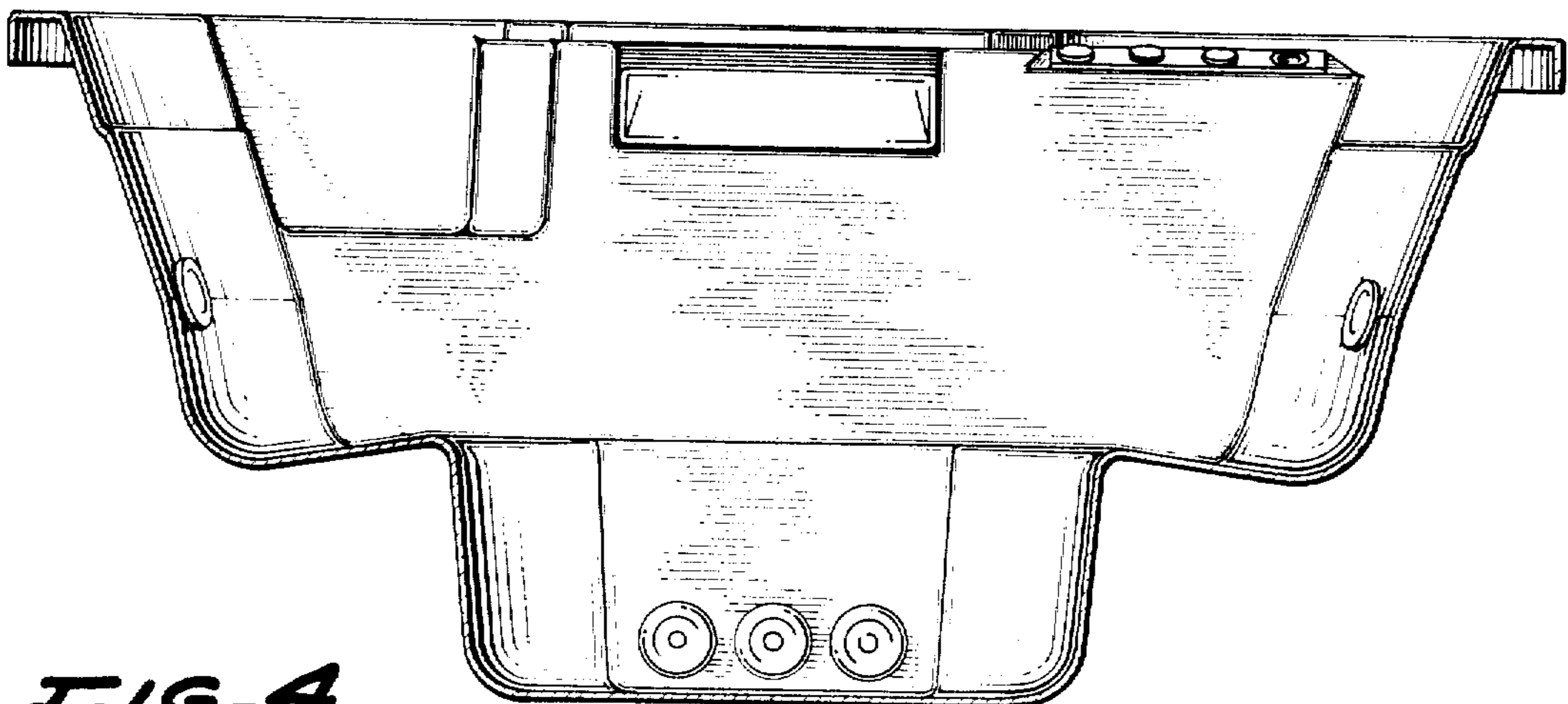
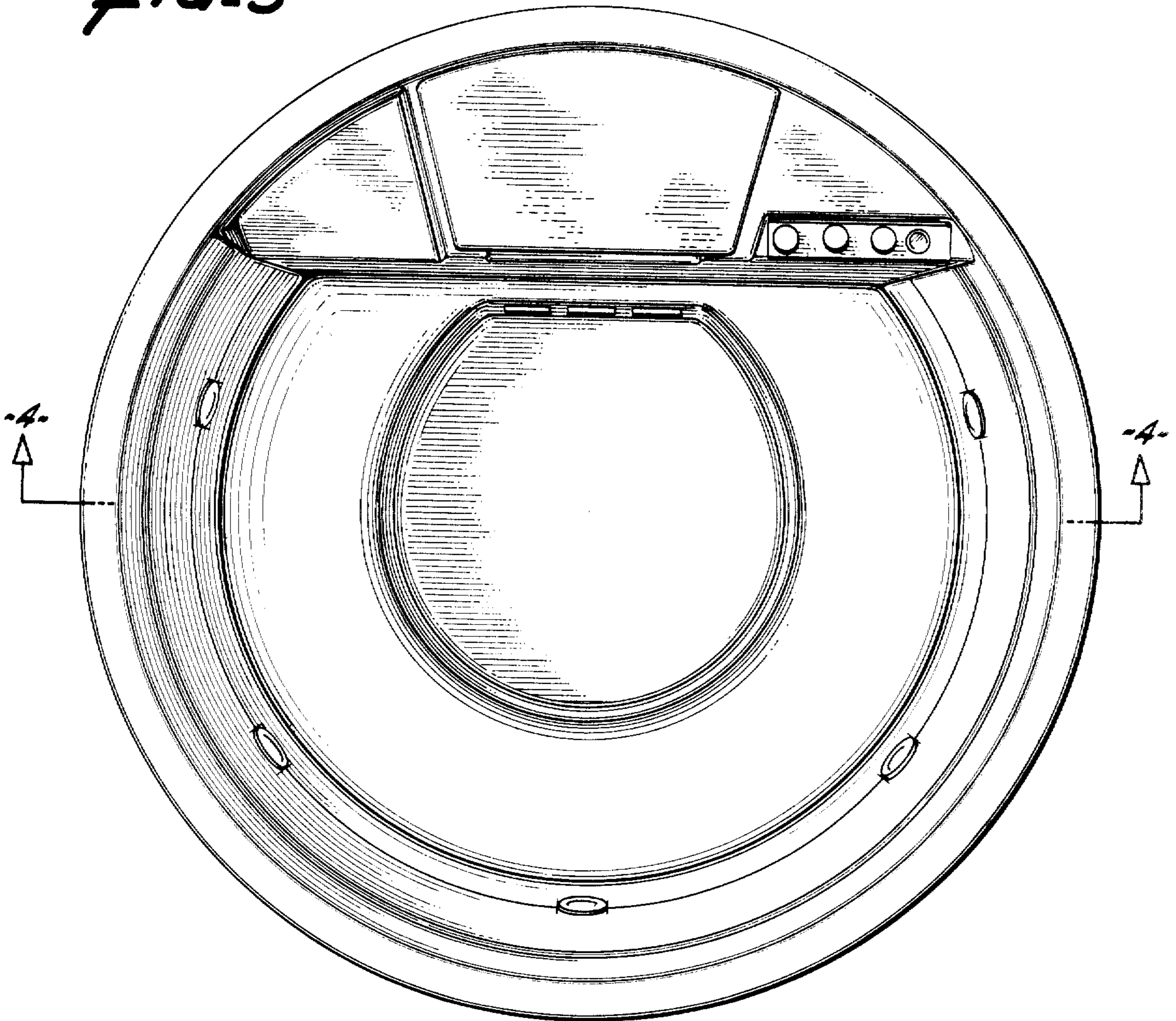


*FIG-1*



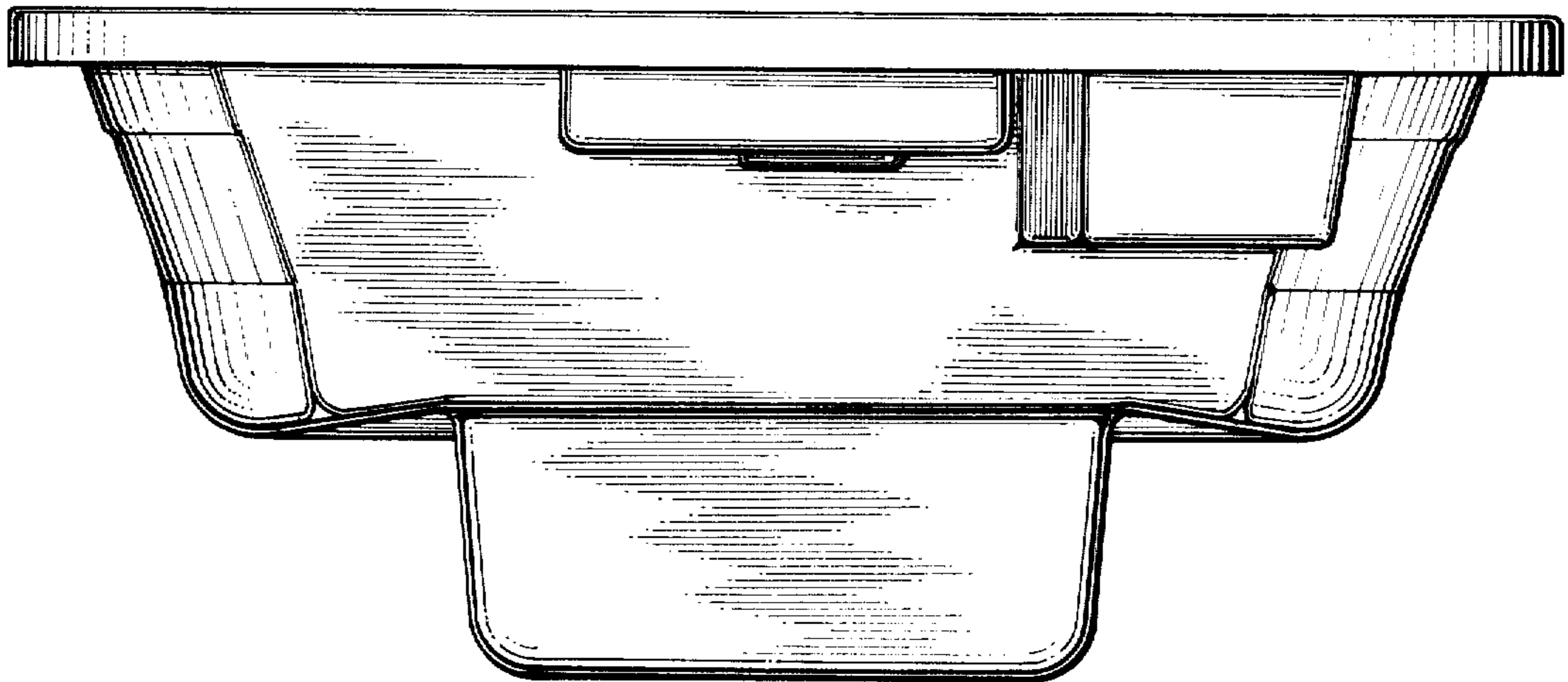
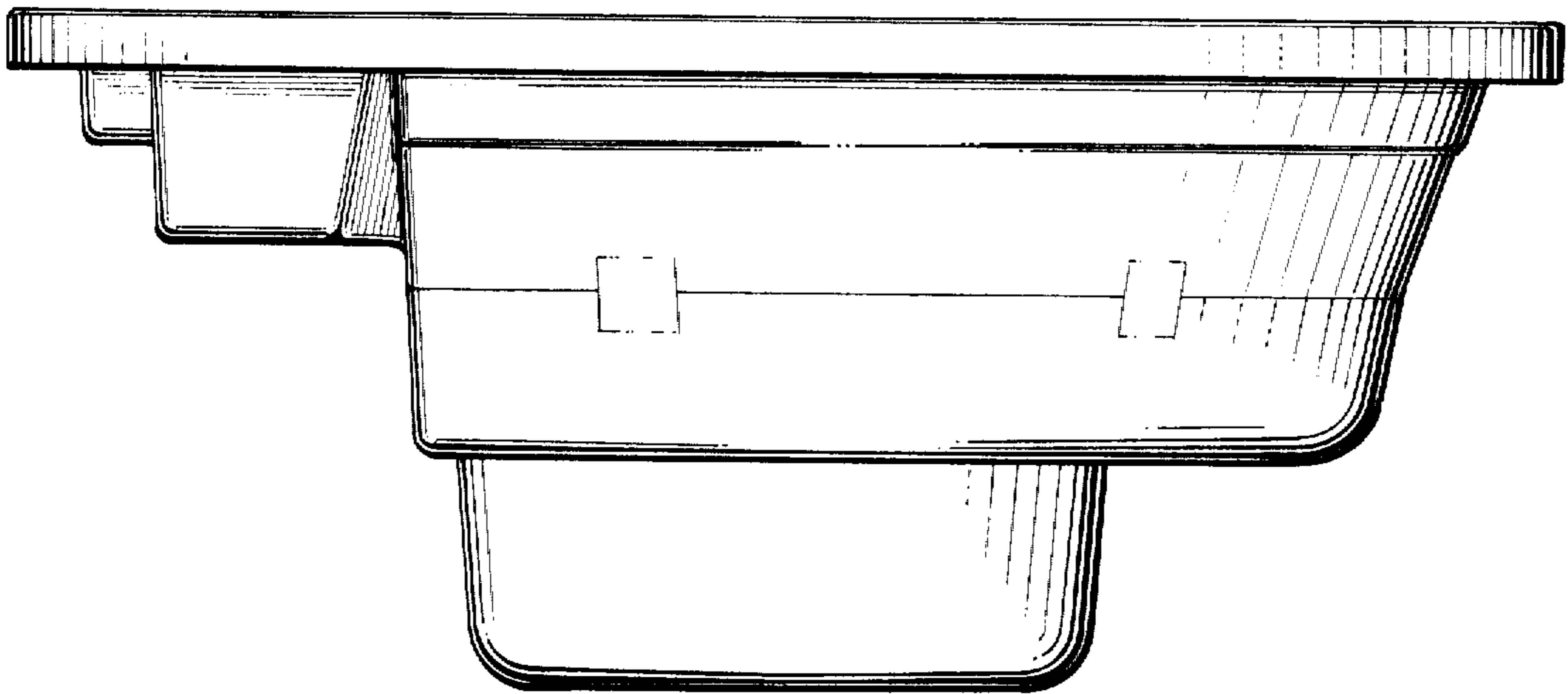
*FIG-2*

**FIG-3**



**FIG-4**

*FIG-5*



*FIG-6*