

[54] PHOTOGRAPH ALBUM

[75] Inventor: Sheldon Plutsky, Chatsworth, Calif.

[73] Assignee: Pioneer Photo Albums, Inc., Chatsworth, Calif.

[\*\*] Term: 14 Years

[21] Appl. No.: 106,475

[22] Filed: Dec. 26, 1979

[51] Int. Cl. .... D19-04

[52] U.S. Cl. .... D19/26

[58] Field of Search ..... D19/26-32; D3/30, 33, 42, 76; 40/382, 391, 399, 534; 281/15 A

[56] References Cited

U.S. PATENT DOCUMENTS

D. 242,139 11/1976 Turner ..... D19/26  
3,363,349 1/1968 Nelson ..... 40/391

OTHER PUBLICATIONS

John A. Meier Co. Cat., 1966-1967, p. 49, top left.

Primary Examiner—George P. Word  
Attorney, Agent, or Firm—Spensley, Horn, Jubas & Lubitz

[57] CLAIM

The ornamental design for a photograph album, substantially as shown and described.

DESCRIPTION

FIG. 1 is a perspective view of a photograph album showing my new design;  
FIG. 2 is a bottom rear perspective view thereof;  
FIG. 3 is a perspective view of the photograph album in a partially open position showing the Velcro fasteners;  
FIG. 4 is a perspective thereof in the nearly fully opened position;  
FIG. 5 is a bottom end elevational view of the fully opened photograph album;  
FIG. 6 is a right side elevational view thereof;  
FIG. 7 is an enlarged scale perspective view of one of the folding sections of the photograph album; and  
FIG. 8 is an enlarged scale cross sectional view taken along line 8-8 of FIG. 7 showing the interlocks.

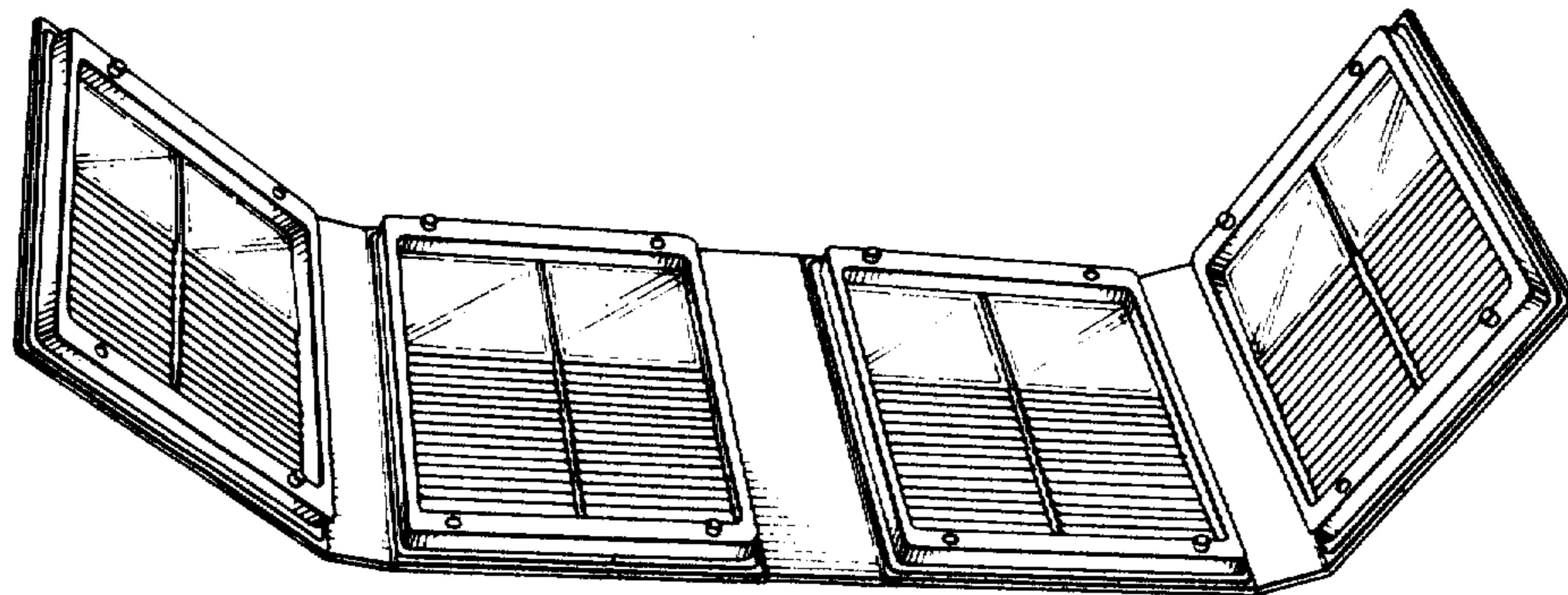

*FIG. 1.*

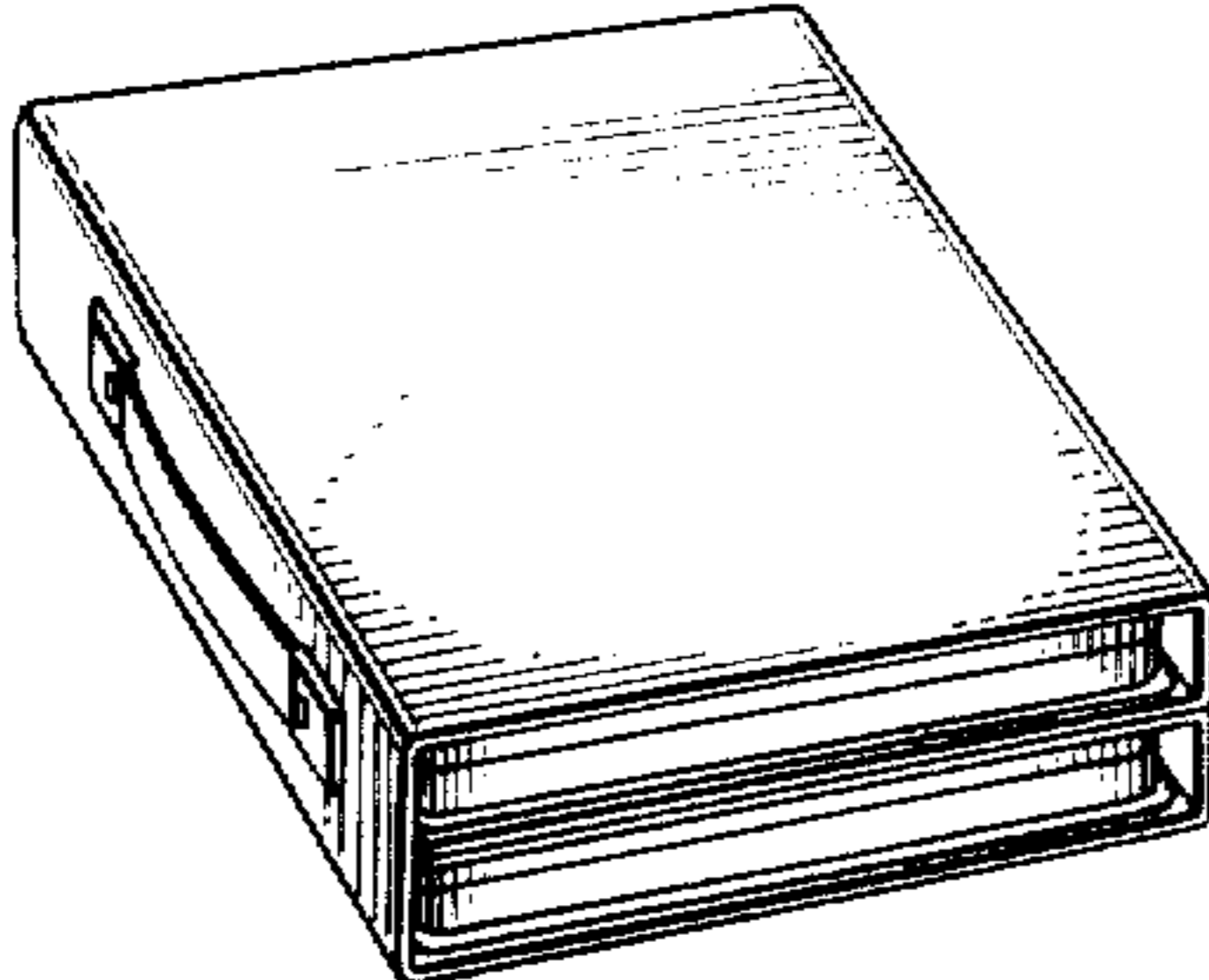

*FIG. 2.*

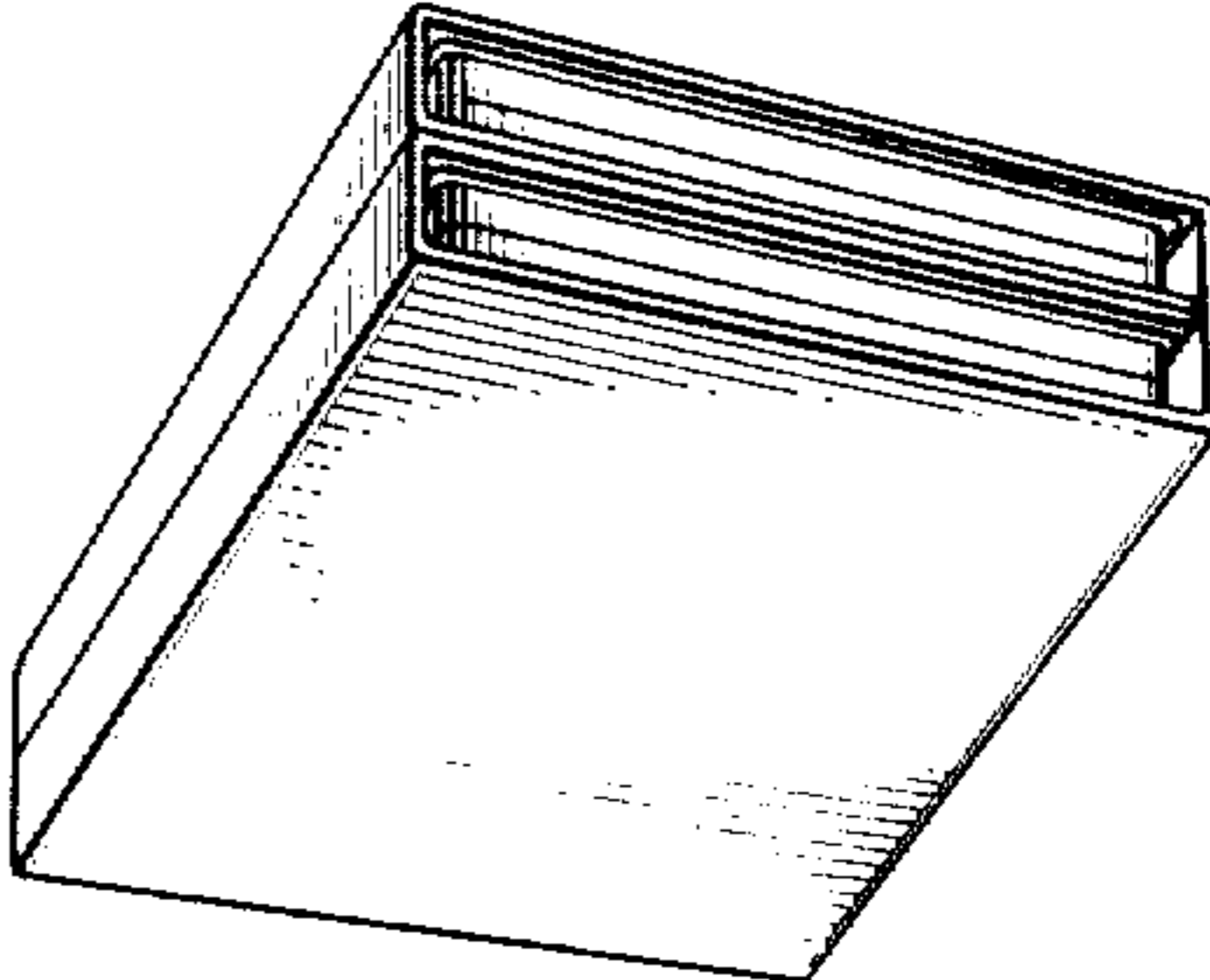

*FIG. 3.*

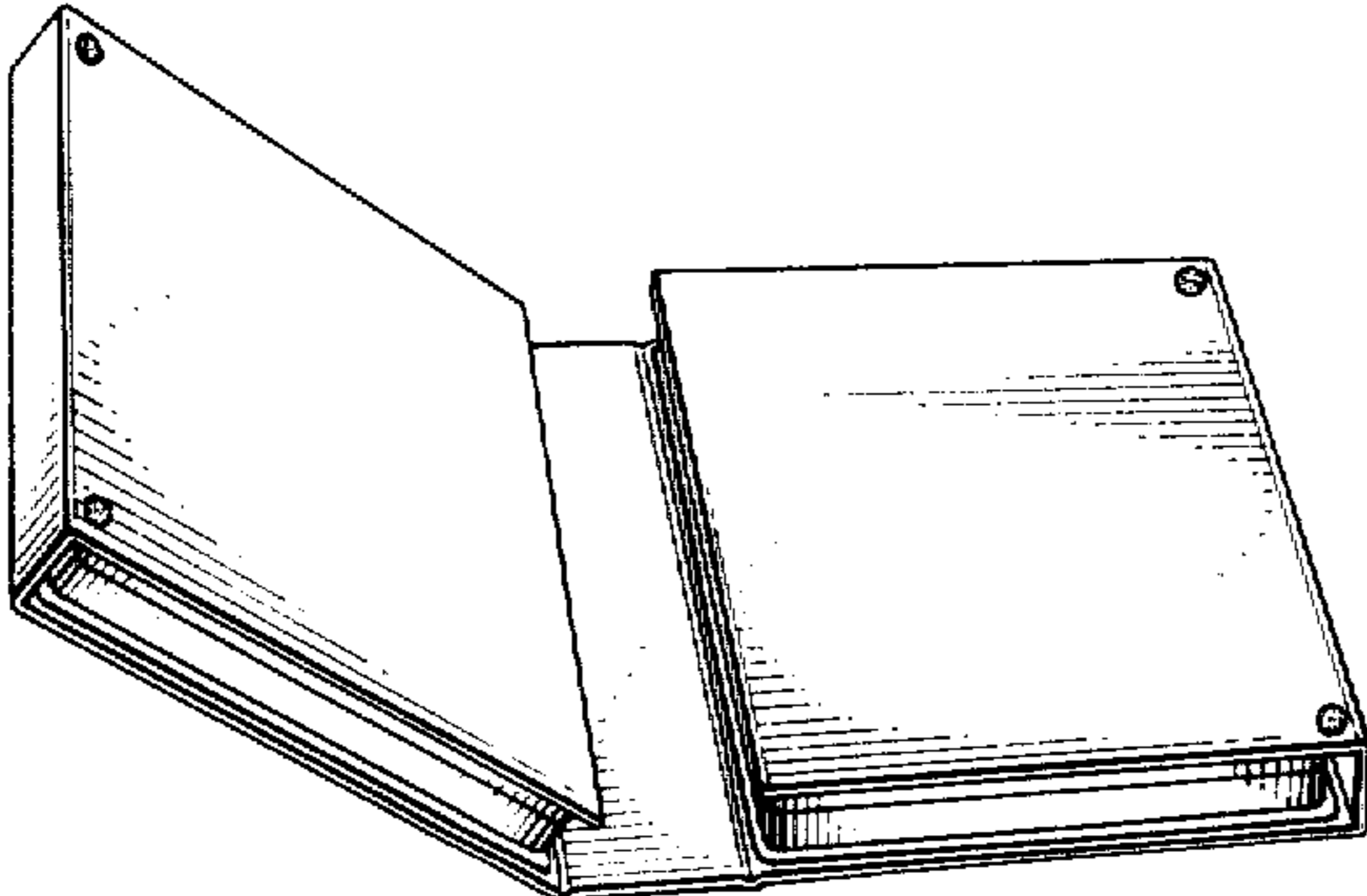

*FIG. 4.*

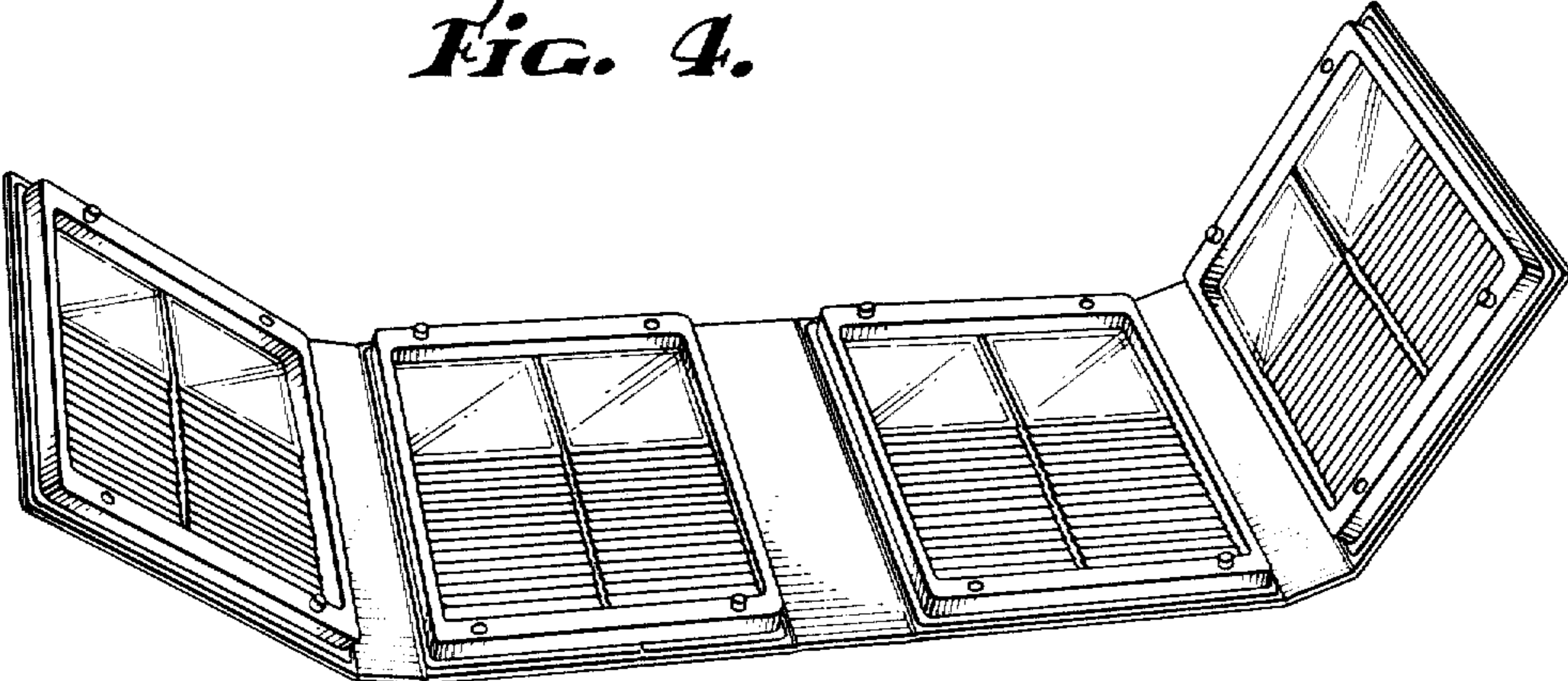

*FIG. 5.*



*FIG. 6.*

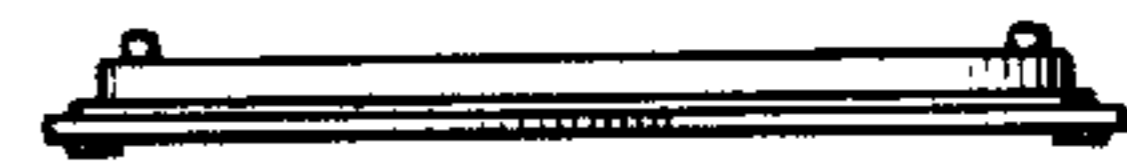

*FIG. 7.*

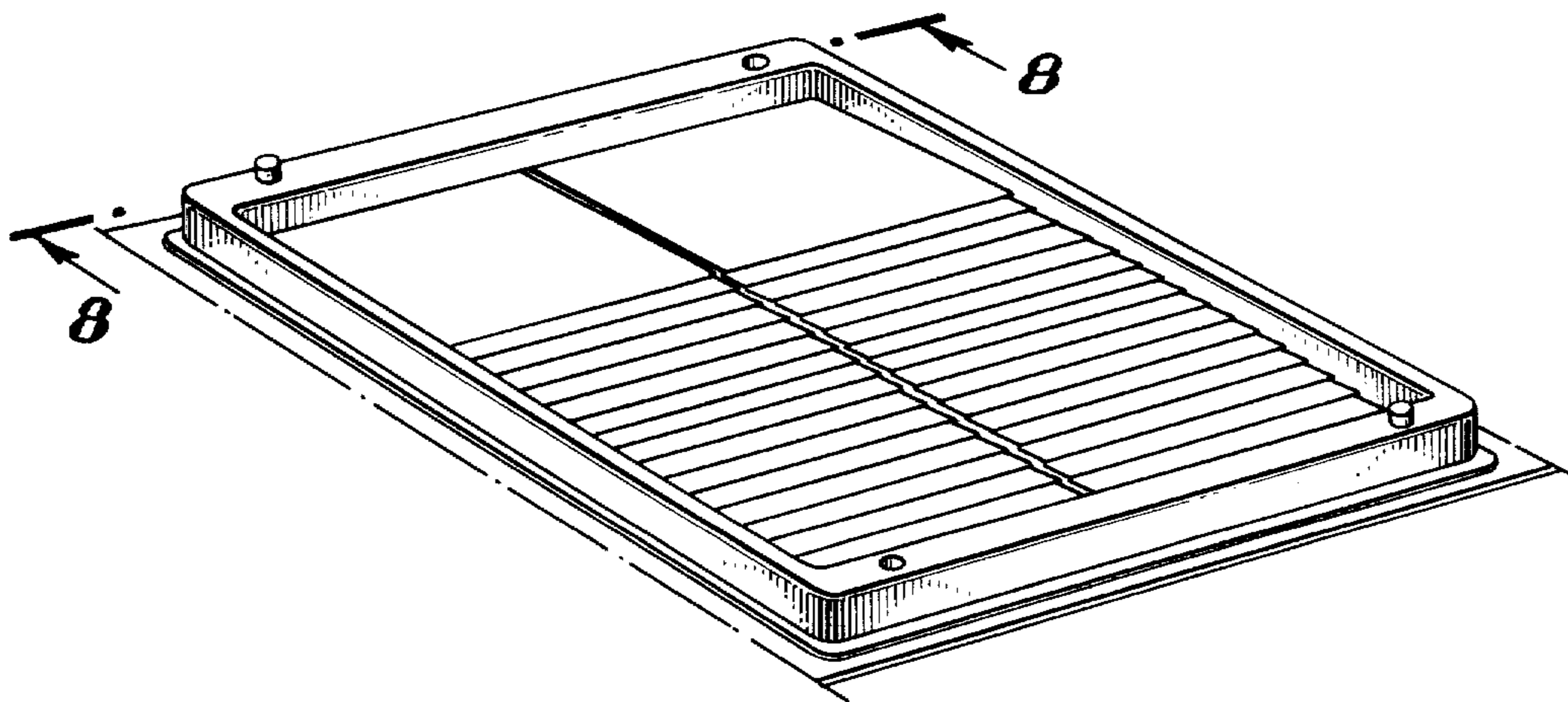

*FIG. 8.*

