

[54] **BARBEQUE GRILL CLEANER**
 [76] Inventor: **Roscoe W. Ashley**, 509 E. Old Shakopee Rd., Apt. 203, Bloomington, Minn. 55420
 [**] Term: **14 Years**
 [21] Appl. No.: **56,007**
 [22] Filed: **Jul. 9, 1979**
 [51] Int. Cl. **D7-05**
 [52] U.S. Cl. **D32/49**
 [58] Field of Search **D7/181-185; 15/105, 236 R; 30/169, 171, 172**

[56] **References Cited**
U.S. PATENT DOCUMENTS

D. 204,004	3/1966	Hawkins .	
D. 208,249	8/1967	Prunchak	D7/181
215,077	5/1879	Stone .	
313,244	3/1885	Sauer	30/171 X
790,228	5/1905	Rohrer	30/171 X
2,253,116	8/1941	Findlay	15/236 R
2,599,193	6/1952	Morris	30/169
2,747,911	5/1956	Kuever .	
2,824,323	2/1958	Tos et al. .	
2,900,656	8/1959	Tupper .	
3,366,987	2/1968	Giustino .	
3,434,175	3/1969	Bray .	
3,797,581	3/1974	Holloway .	
3,800,354	4/1974	Stephens .	
4,090,730	5/1978	Zeigler .	
4,112,537	9/1978	Heuck .	

Primary Examiner—Catherine E. Kemper
Attorney, Agent, or Firm—Burd, Bartz & Gutenkauf

[57] **CLAIM**

The ornamental design for a barbeque grill cleaner, substantially as shown and described.

DESCRIPTION

FIG. 1 is a perspective view of a barbeque grill cleaner, showing my new design;
 FIG. 2 is an enlarged right end elevational view thereof;
 FIG. 3 is an enlarged left end elevational view thereof;
 FIG. 4 is an elevational view taken from the top of FIG. 2;
 FIG. 5 is an elevational view taken from the bottom of FIG. 2;
 FIG. 6 is an elevational view taken from the right of FIG. 2;
 FIG. 7 is an elevational view taken from the left of FIG. 2;
 FIG. 8 is a perspective view of a second embodiment of a barbecue grill cleaner;
 FIG. 9 is an enlarged right end elevational view thereof;
 FIG. 10 is an enlarged left end elevational view thereof;
 FIG. 11 is an elevational view taken from the top of FIG. 9;
 FIG. 12 is an elevational view taken from the bottom of FIG. 9;
 FIG. 13 is an elevational view taken from the right side of FIG. 9;
 FIG. 14 is an elevational view taken from the left side of FIG. 9.

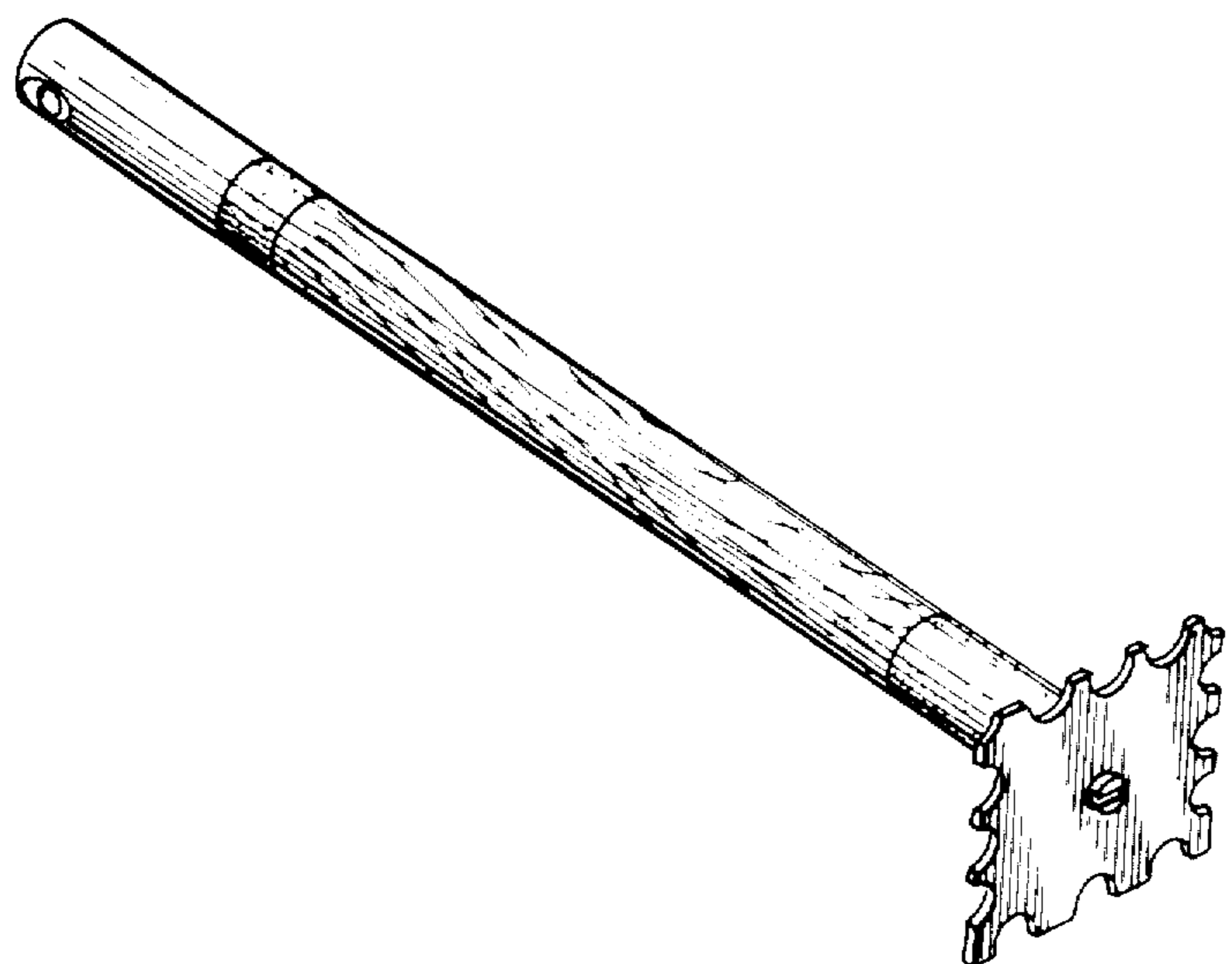

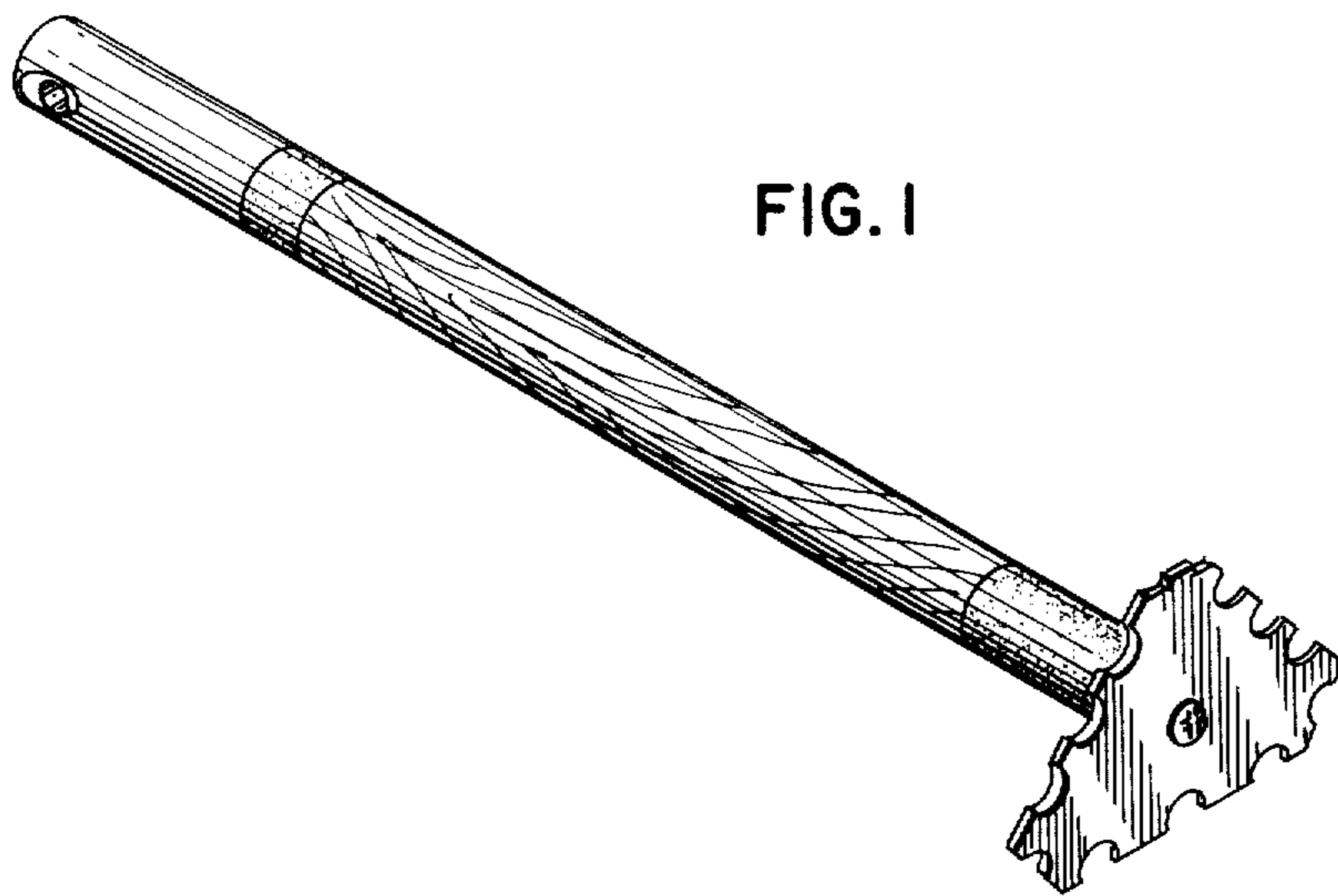

FIG. 1

FIG. 2

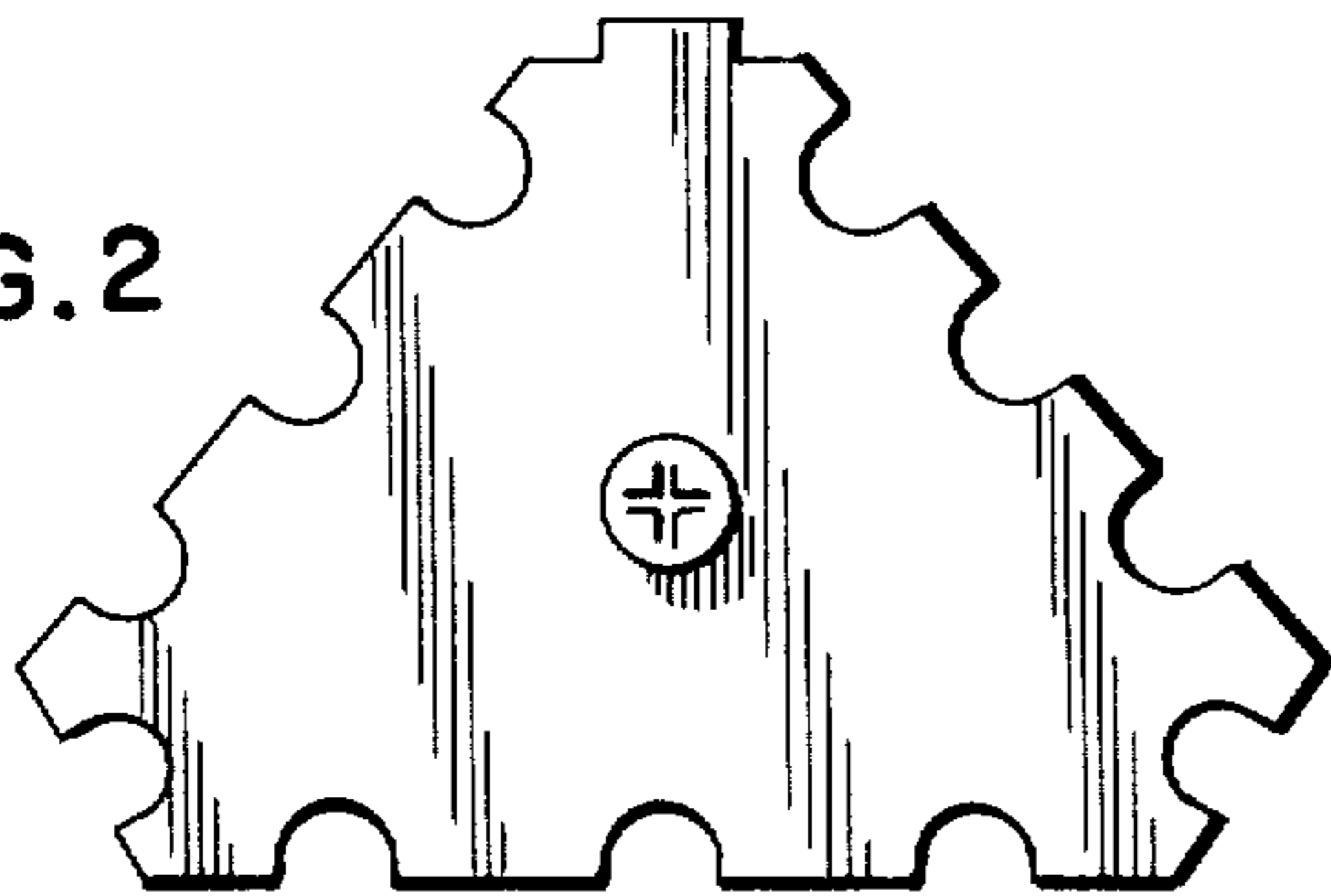

FIG. 3

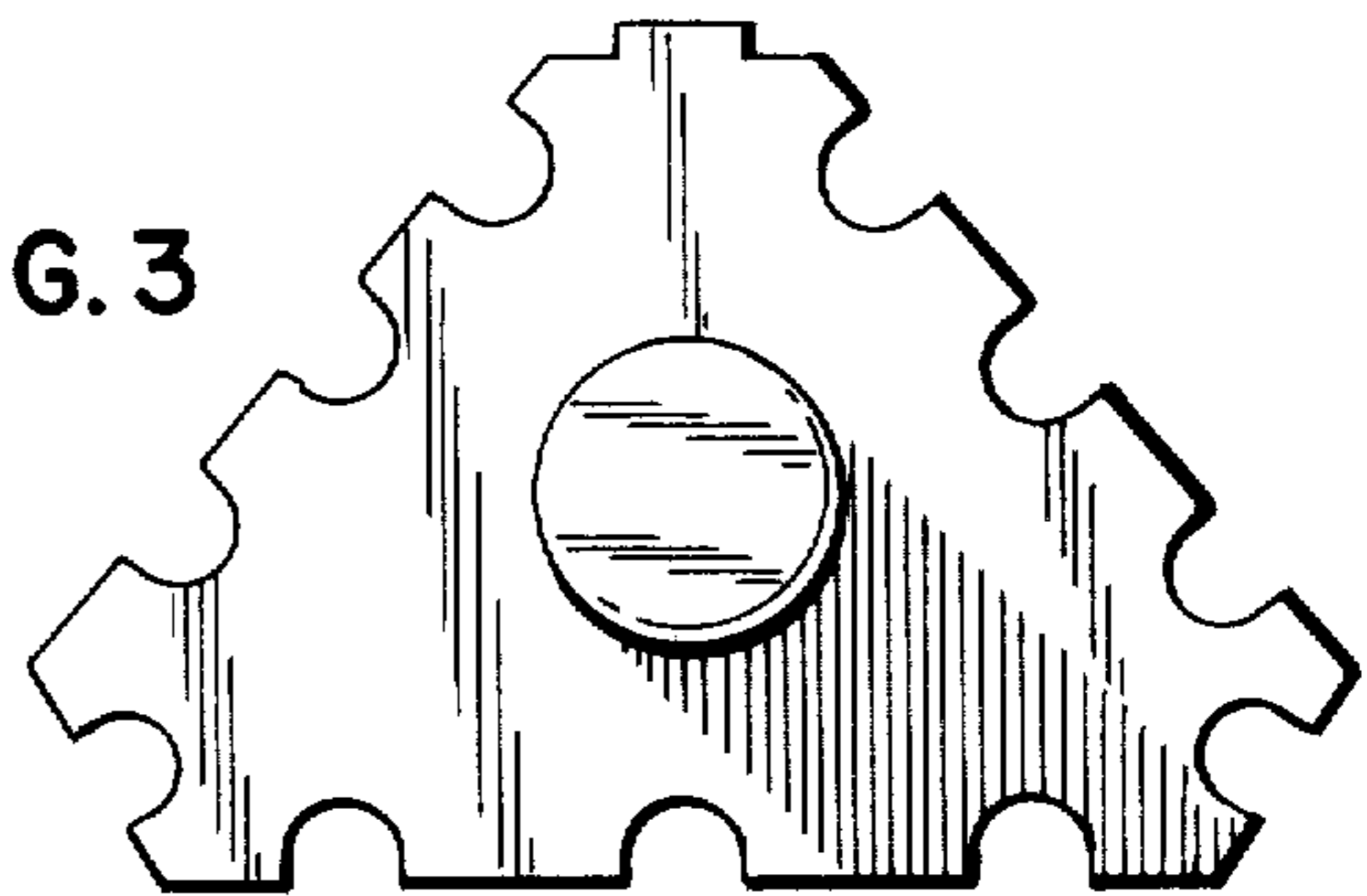

FIG. 4

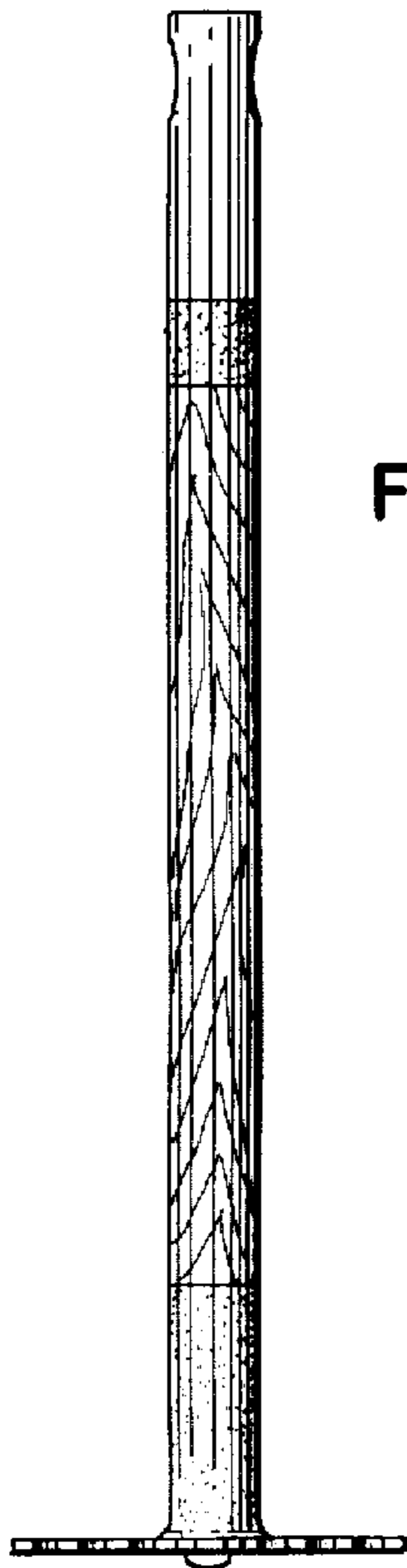

FIG. 5

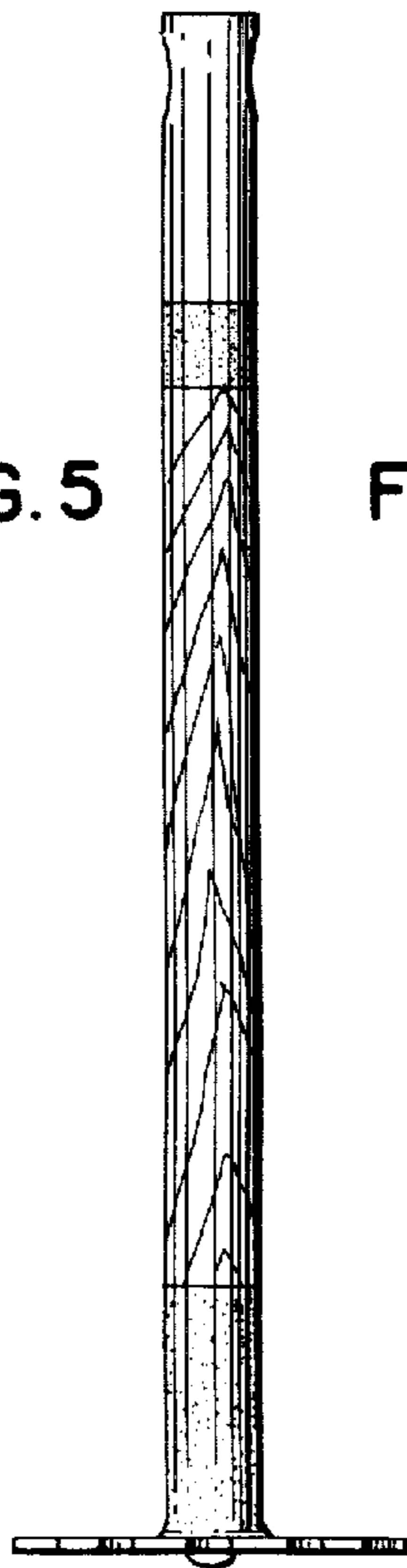

FIG. 6

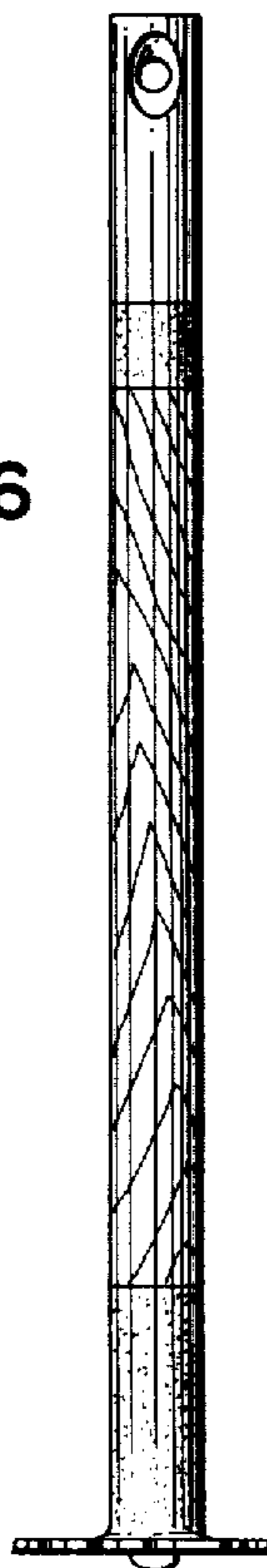
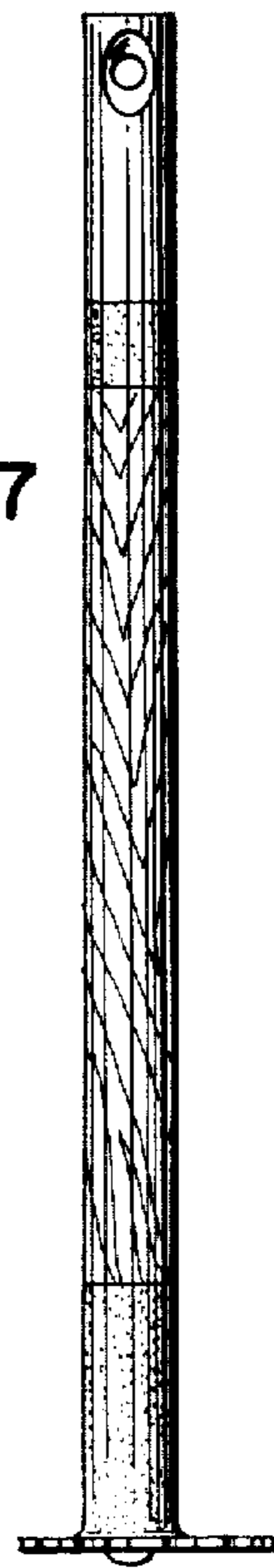

FIG. 7



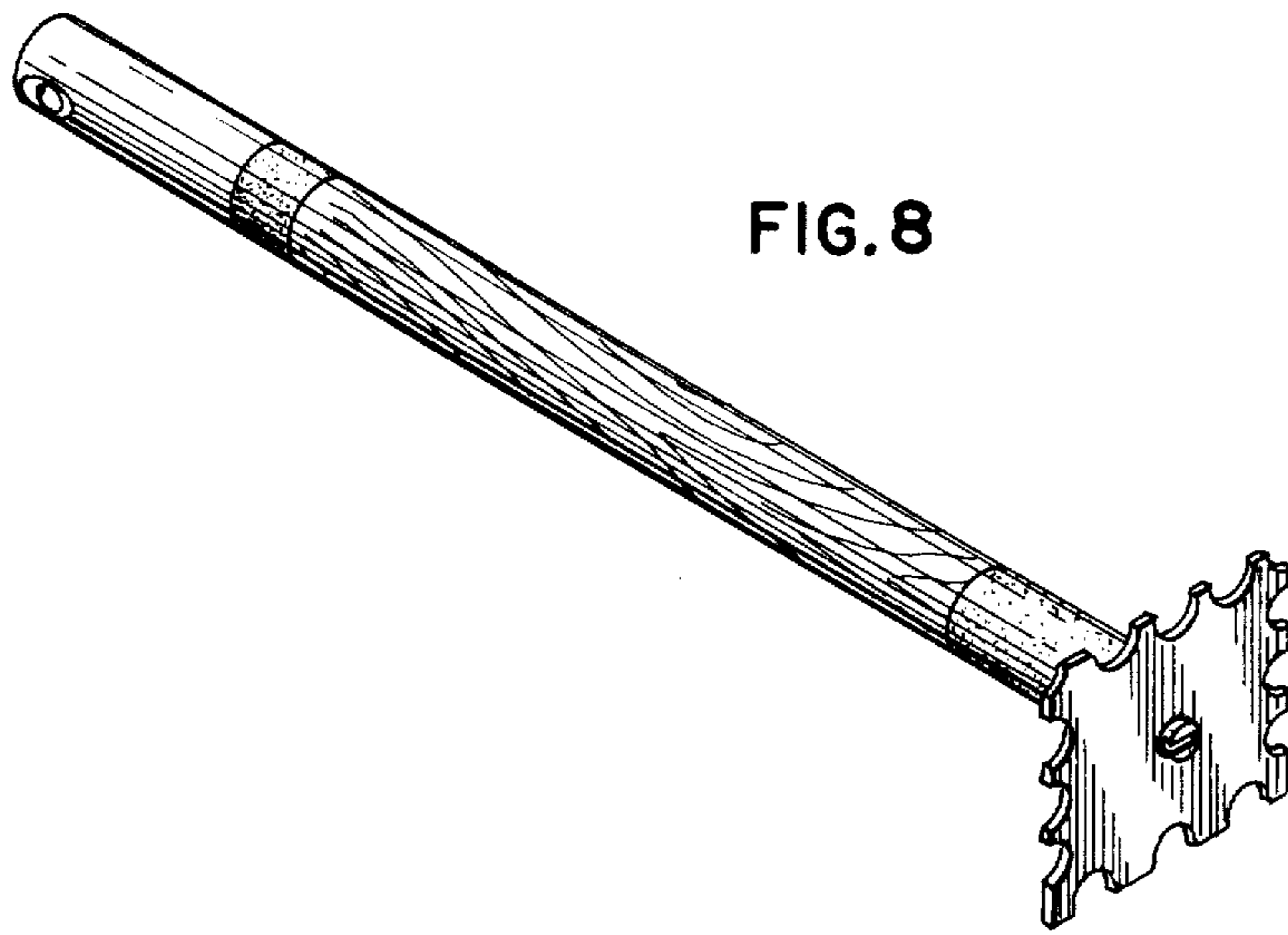

FIG. 9

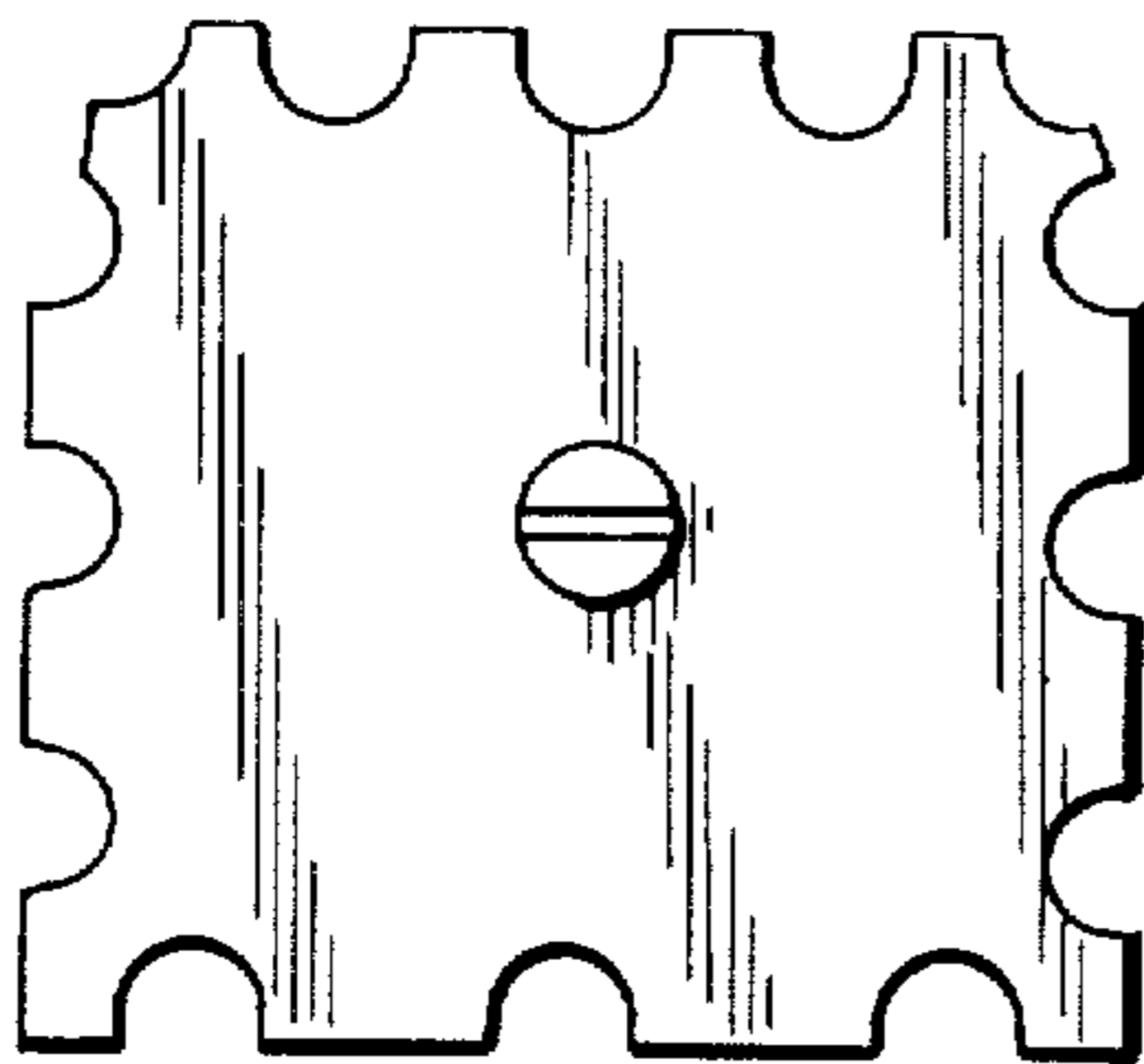

FIG. 10

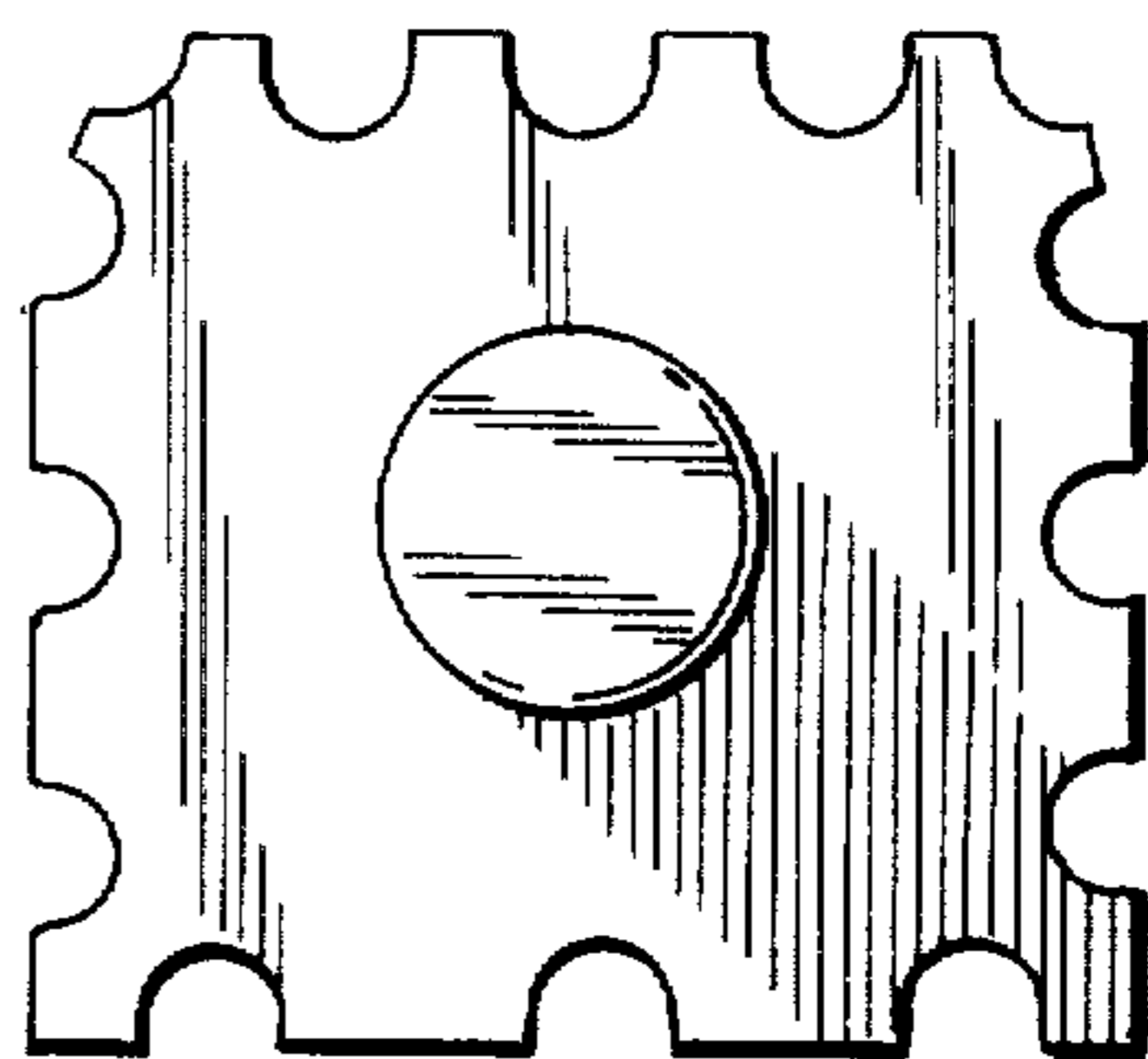

FIG. 11

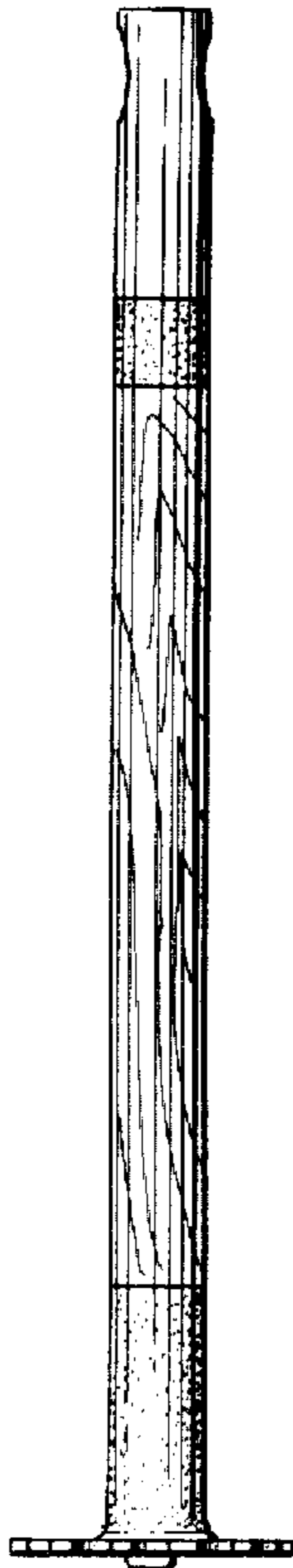

FIG. 12

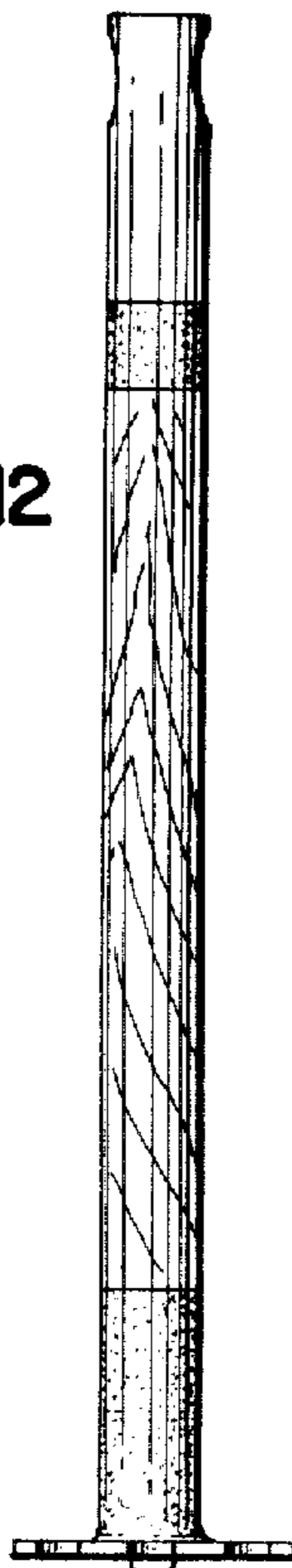

FIG. 13

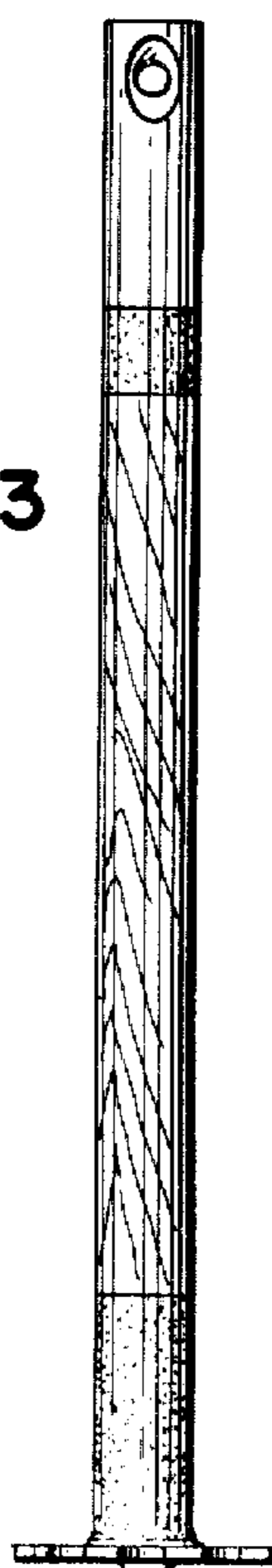

FIG. 14

