

[54] ARM WRESTLING EXERCISE TABLE

D. 226,117 1/1973 Krause D21/195
2,855,199 10/1958 Noland et al. 272/134
3,947,025 3/1976 Hobby 272/135

[76] Inventor: **Ronald J. Vyhlidal**, 1648 W. 10th St.,
Fremont, Nebr. 68025

[**] Term: **14 Years**

Primary Examiner—Charles A. Rademaker
Attorney, Agent, or Firm—William D. West

[21] Appl. No.: **96,050**

[57] **CLAIM**

[22] Filed: **Nov. 20, 1979**

The ornamental design for an arm wrestling exercise table, as shown and described.

[51] Int. Cl. **D21—02**

DESCRIPTION

[52] U.S. Cl. **D21/195**

[58] Field of Search D21/191, 193, 195, 196,
D21/197, 198, 199; 272/92, 67, 68, 117, 120,
122, 125, 132, 134, 136

FIG. 1 is a front perspective view of an arm wrestling exercise table showing my new design;
FIG. 2 is a front elevational view thereof;
FIG. 3 is a rear elevational view thereof;
FIG. 4 is a right side elevational view thereof; the side opposite being substantially a mirror image;
FIG. 5 is a top plan view thereof; and,
FIG. 6 is a bottom view thereof.

[56] **References Cited**

U.S. PATENT DOCUMENTS

D. 219,663 1/1971 Thompson D21/194

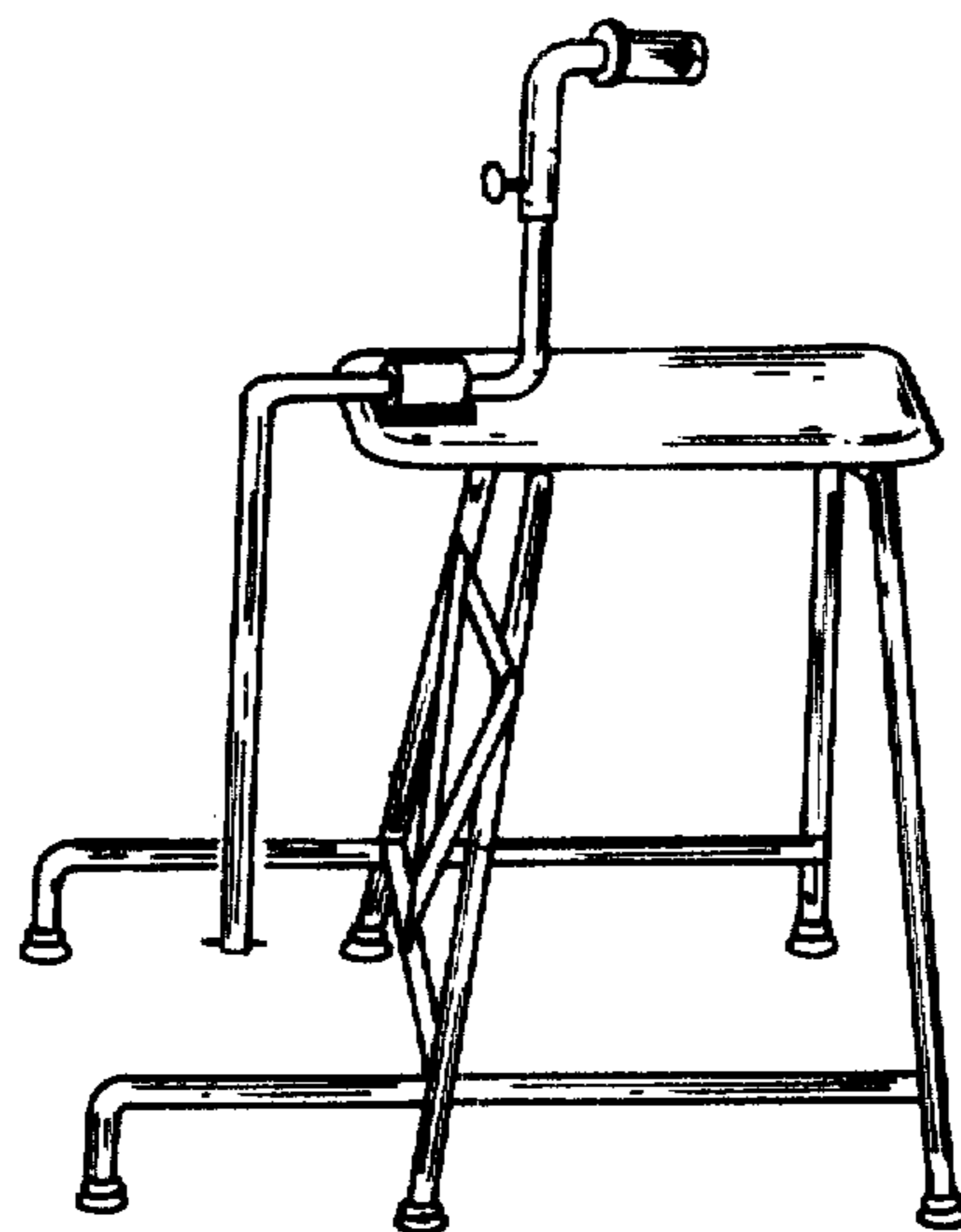

Fig. 1

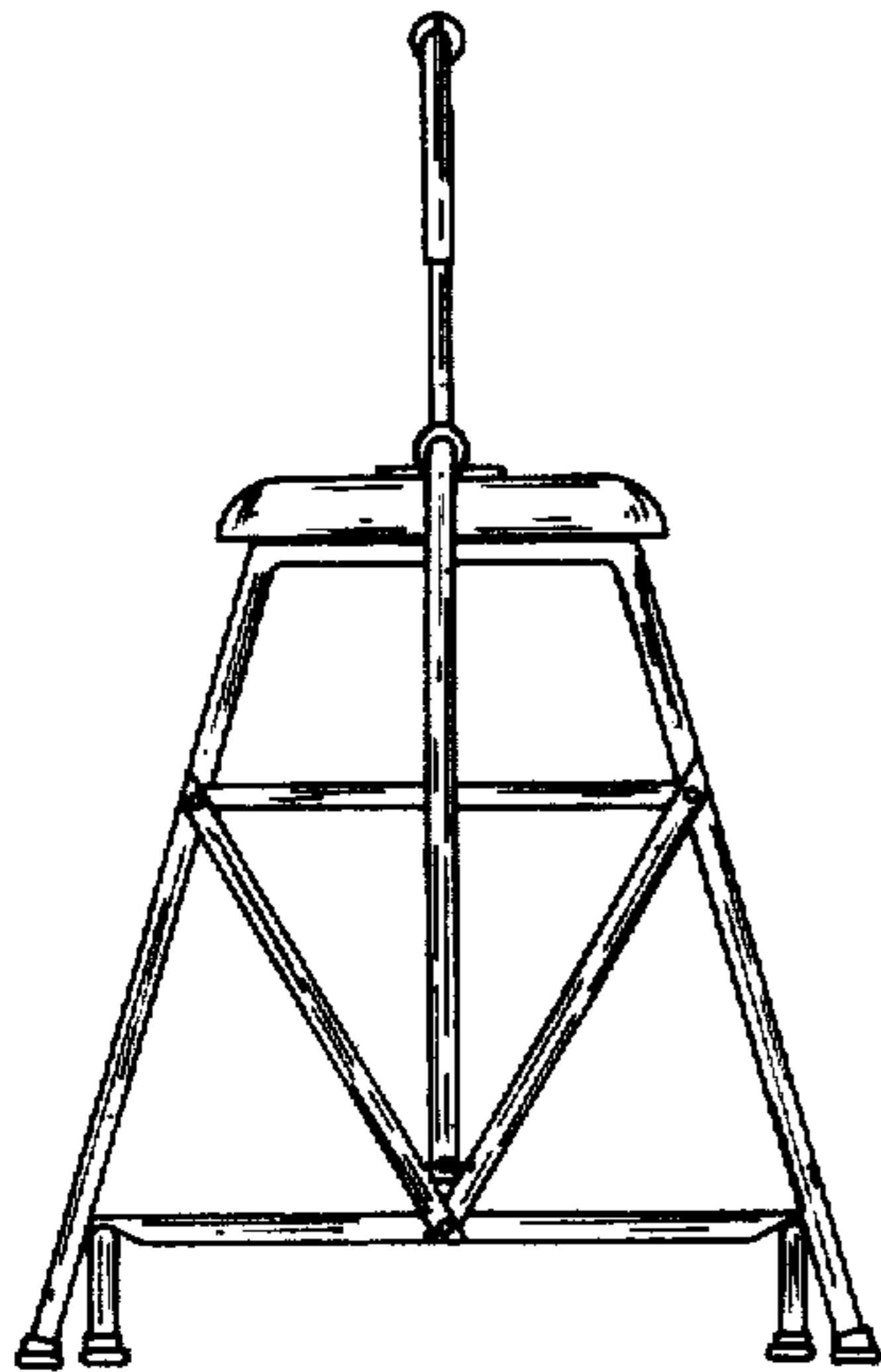
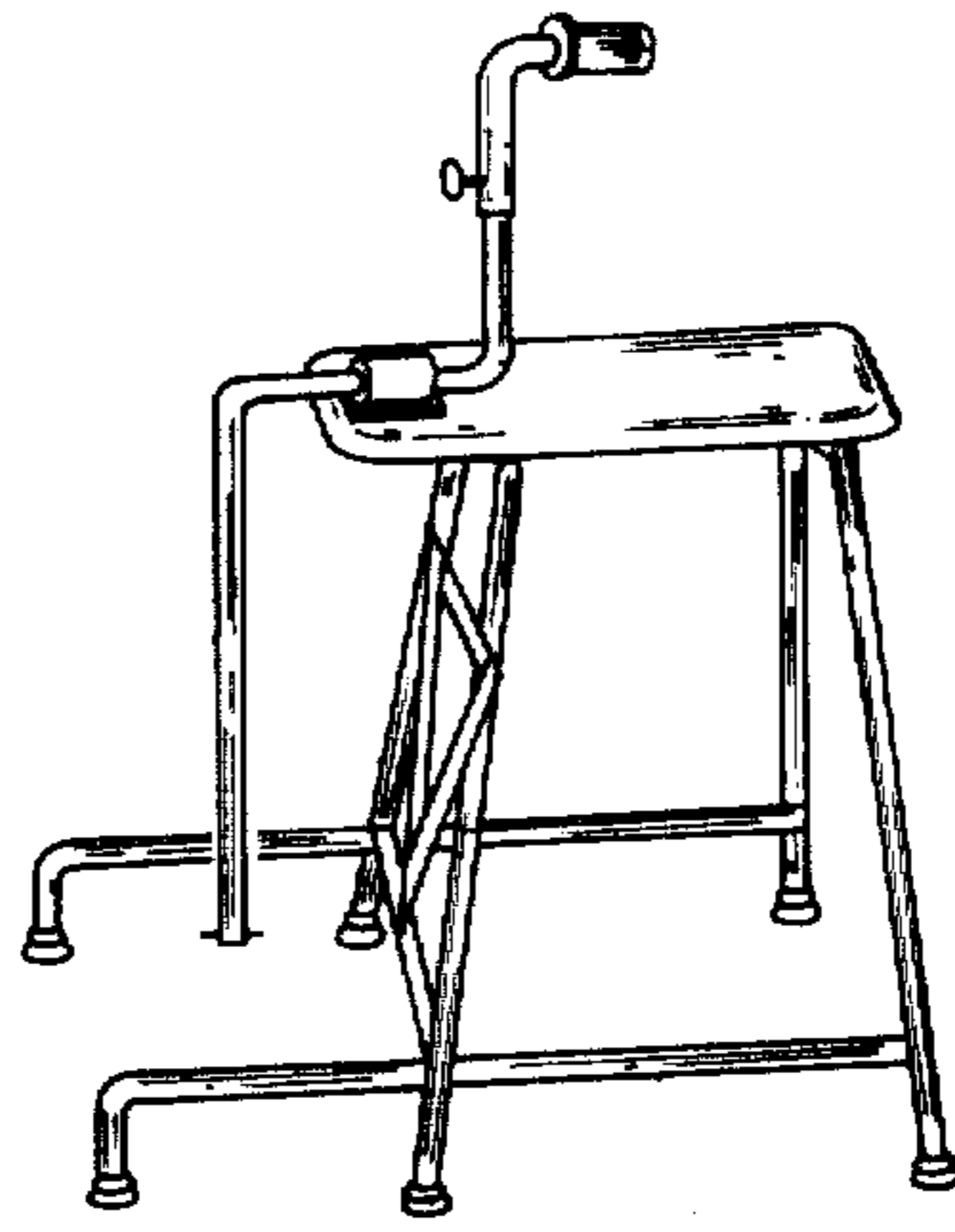

Fig. 2

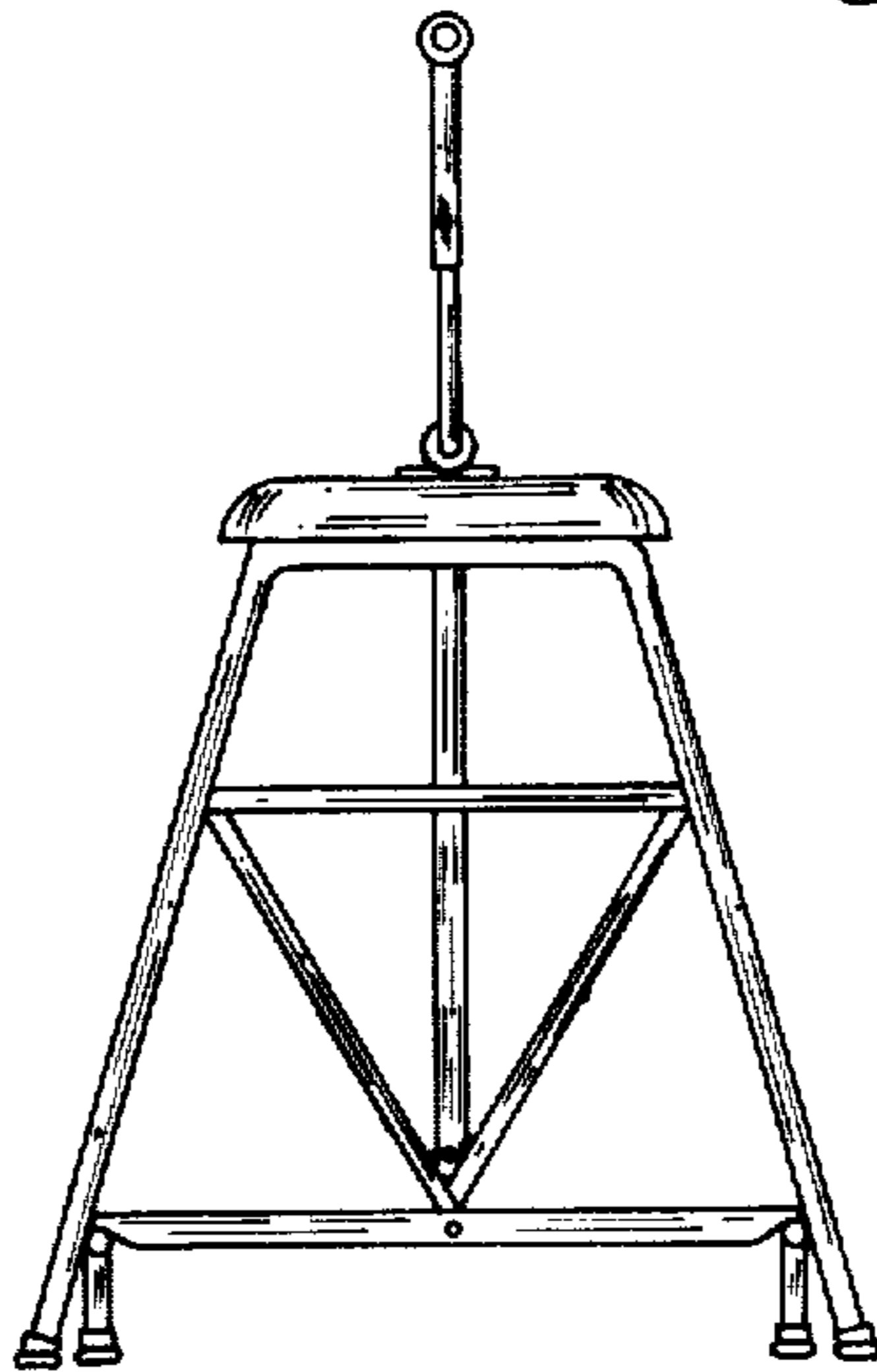

Fig. 3

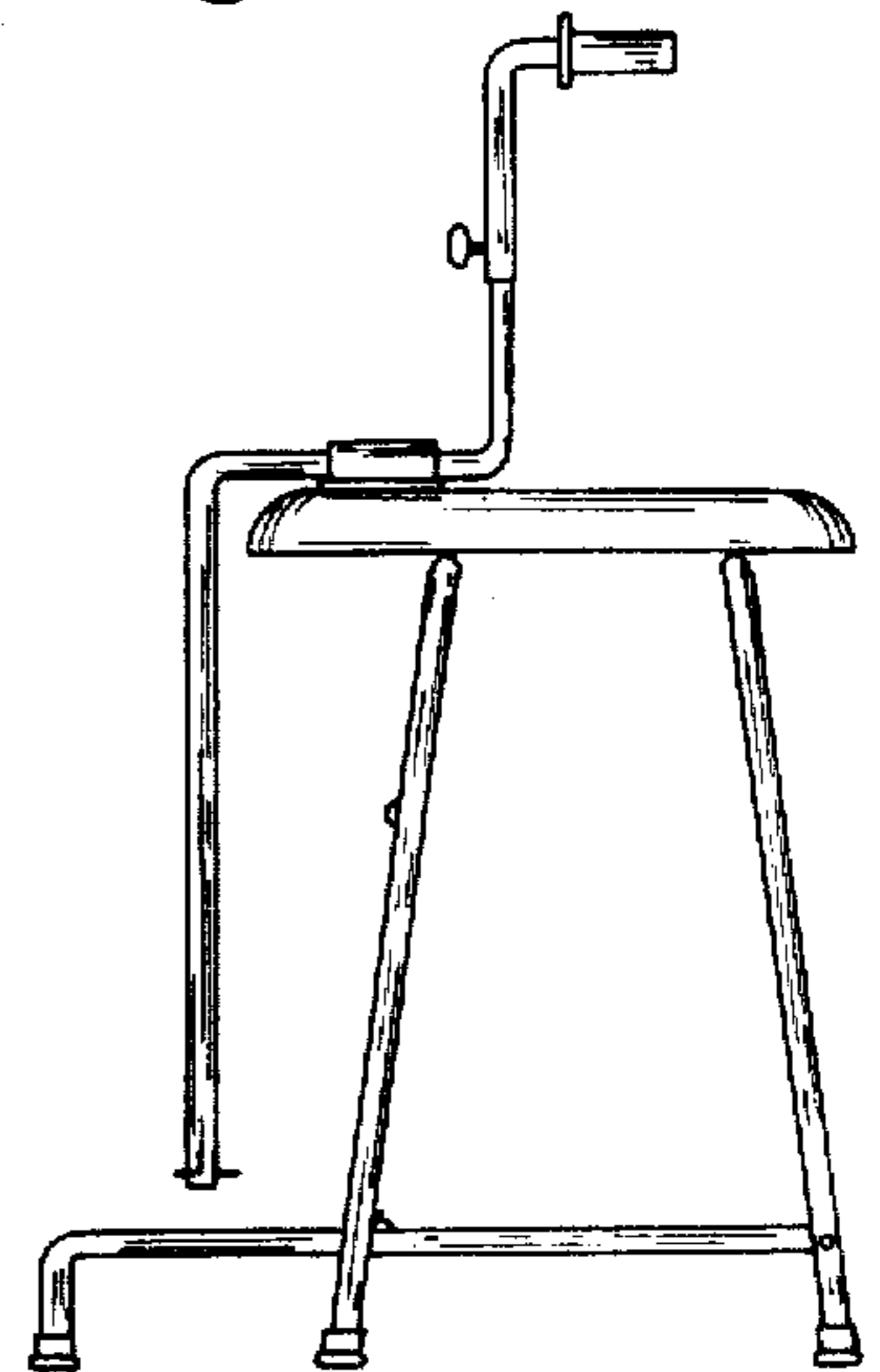

Fig. 4

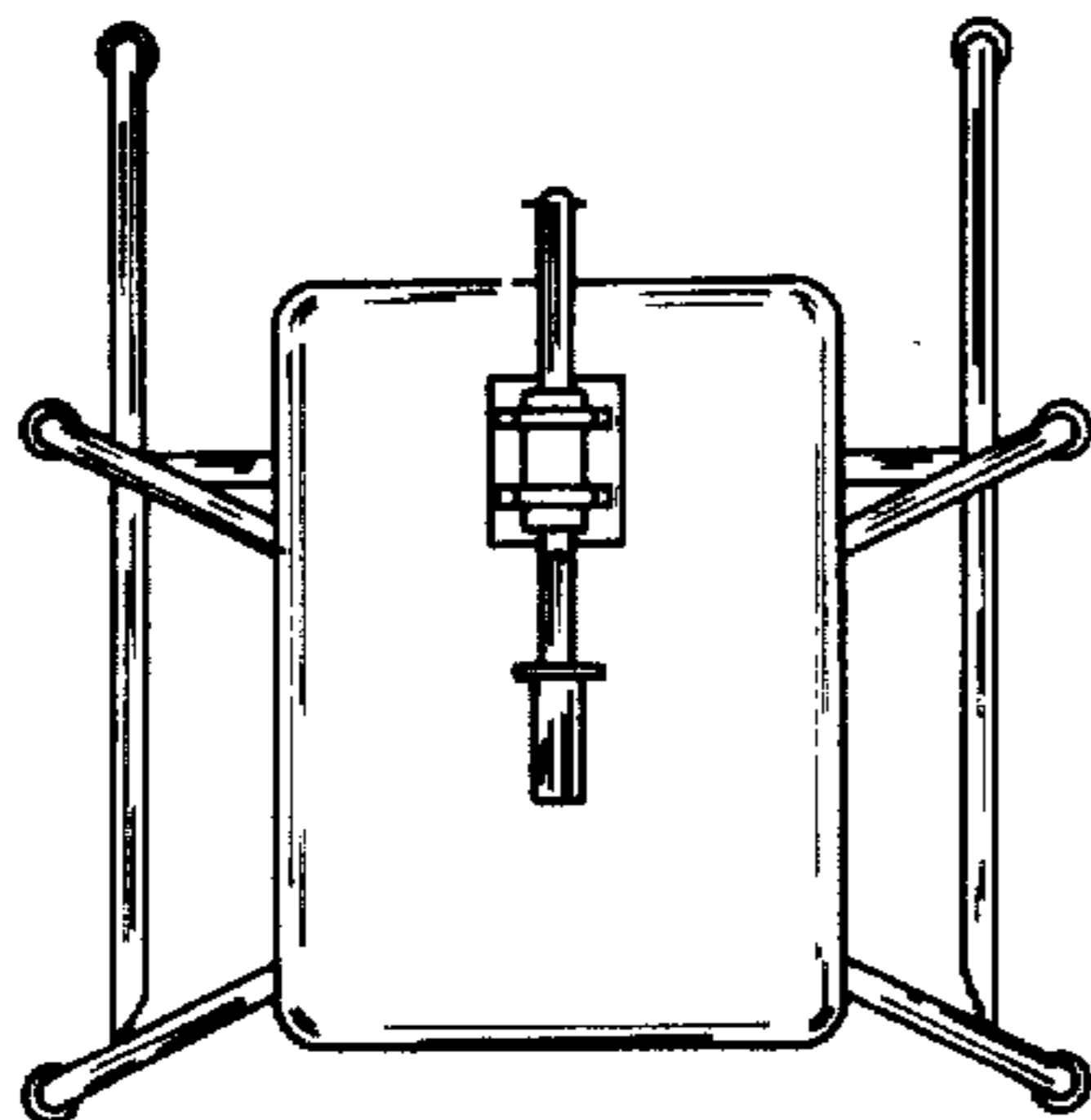

Fig. 5

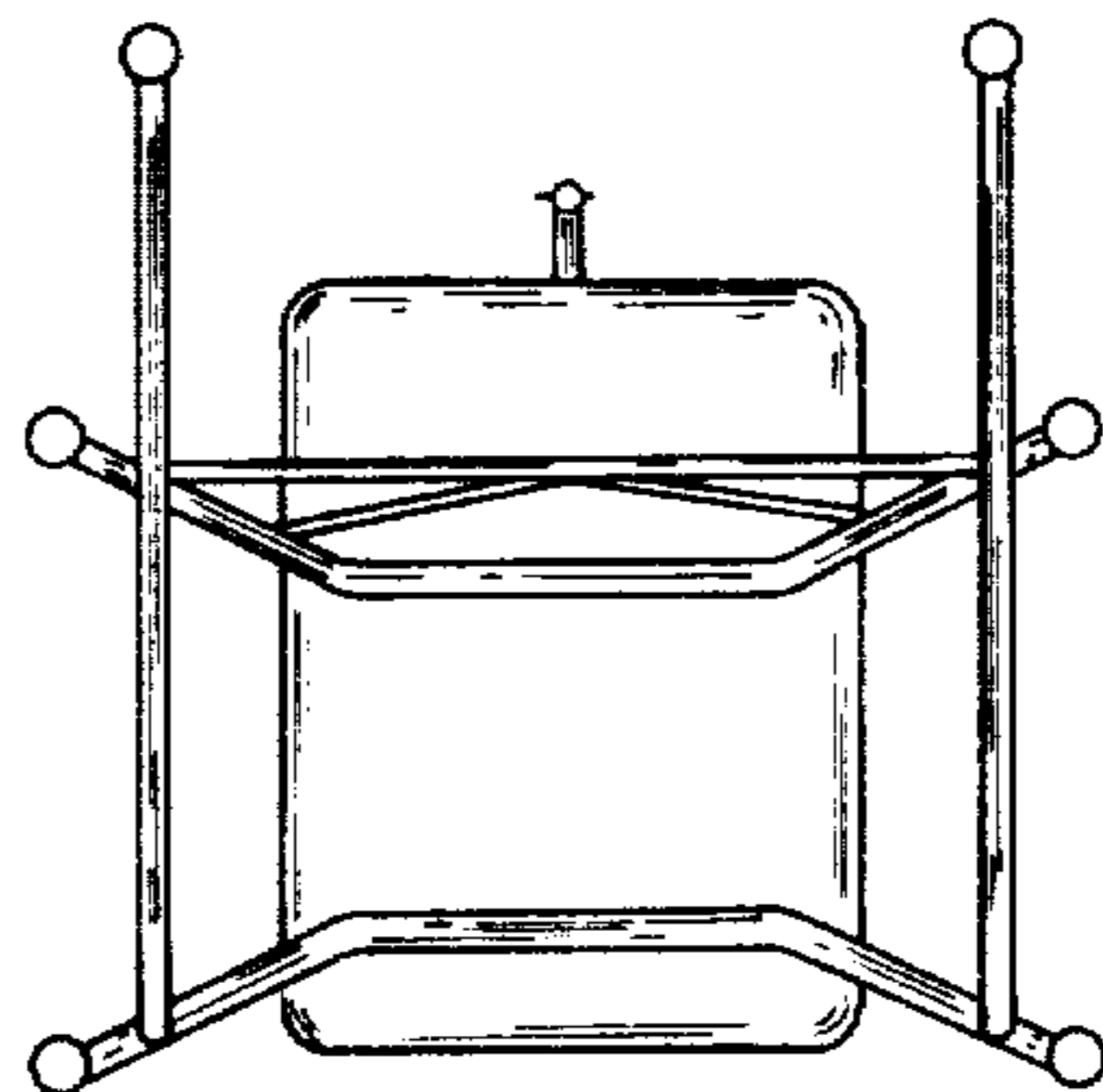

Fig. 6