

[54] WATCH

[75] Inventor: Susumu Suzuki, Suwa, Japan

[73] Assignee: Kabushiki Kaisha Suwa Seikosha, Tokyo, Japan

[\*\*] Term: 3½ Years

[21] Appl. No.: 142,947

[22] Filed: Apr. 23, 1980

[30] Foreign Application Priority Data

Oct. 26, 1979 [JP] Japan ..... 54-45134

[51] Int. Cl. .... D10-02

[52] U.S. Cl. .... D10/38

[58] Field of Search ..... D10/1, 15, 30-39, D10/122-126; 368/82-84, 239-242, 276, 281, 285

[56] References Cited

U.S. PATENT DOCUMENTS

D. 237,149	10/1975	Watanabe	.....	D10/38
D. 247,701	4/1978	Kwon	.....	D10/38
D. 253,520	6/1975	Kwon	.....	D10/39
4,227,777	10/1980	Murakami	.....	368/242 X

OTHER PUBLICATIONS

*Jewelers' Circular-Keystone-2/79*-p. 294-Watch at top 2nd from right.

*Jewelers' Circular-Keystone-9/78* p. 122-Watch at right.

Primary Examiner—Nelson C. Holtje

Attorney, Agent, or Firm—Blum, Kaplan, Friedman, Silberman & Beran

[57] CLAIM

The ornamental design for a watch, as shown and described.

DESCRIPTION

FIG. 1 is a top plan view of a watch showing my new design;

FIG. 2 is a front elevational view thereof in a non-activated condition;

FIG. 3 is a left side elevational view of FIG. 2;

FIG. 4 is a right side elevational view of FIG. 2;

FIG. 5 is a rear elevational view of FIG. 2;

FIG. 6 is a bottom plan view of FIG. 2;

FIG. 7 is a front elevational view of FIG. 1 in an activated condition; and

FIG. 8 is a front elevational view of another embodiment of my new design of FIGS. 1-7, all other views being substantially identical thereto.

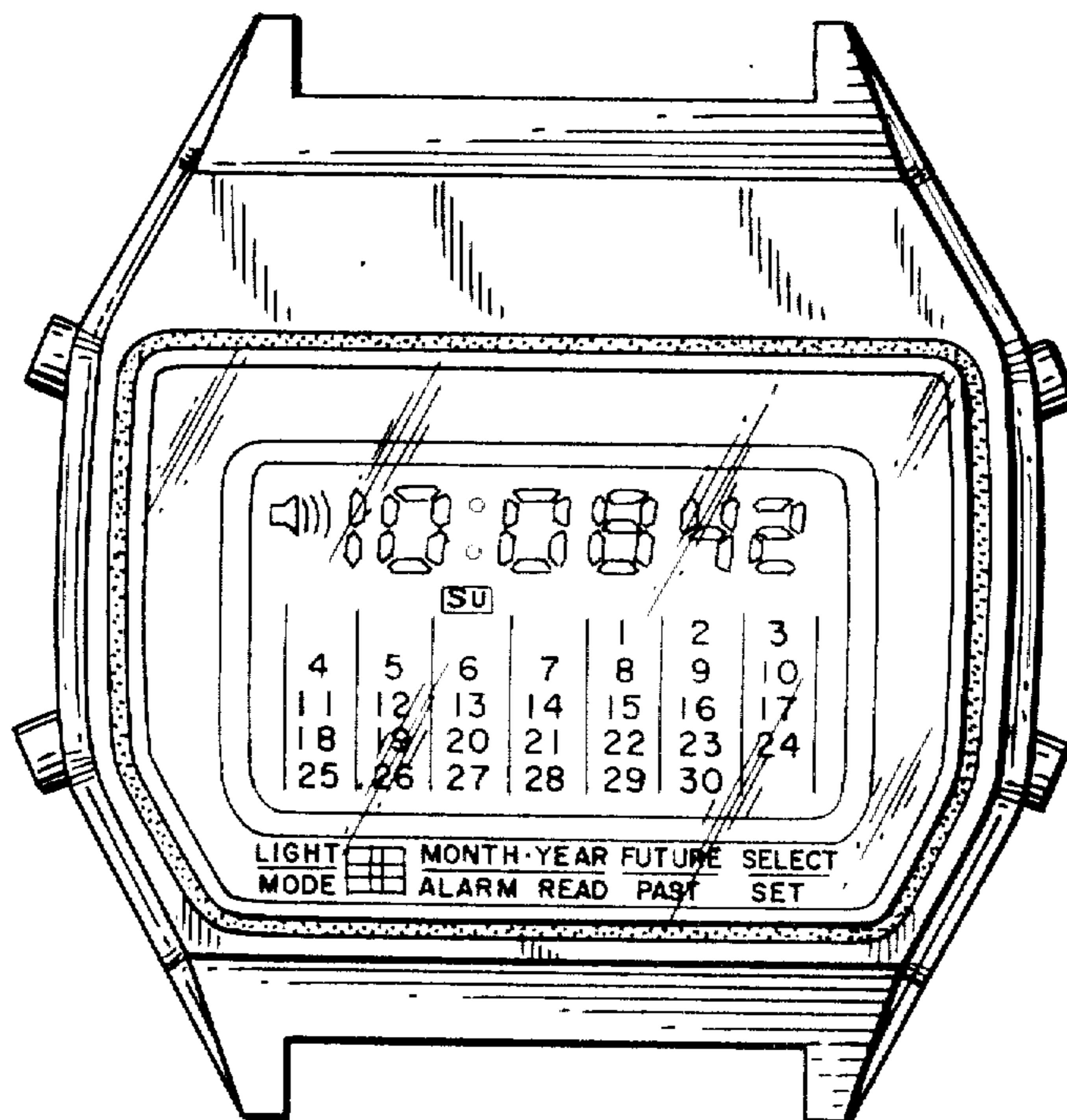

FIG. 1

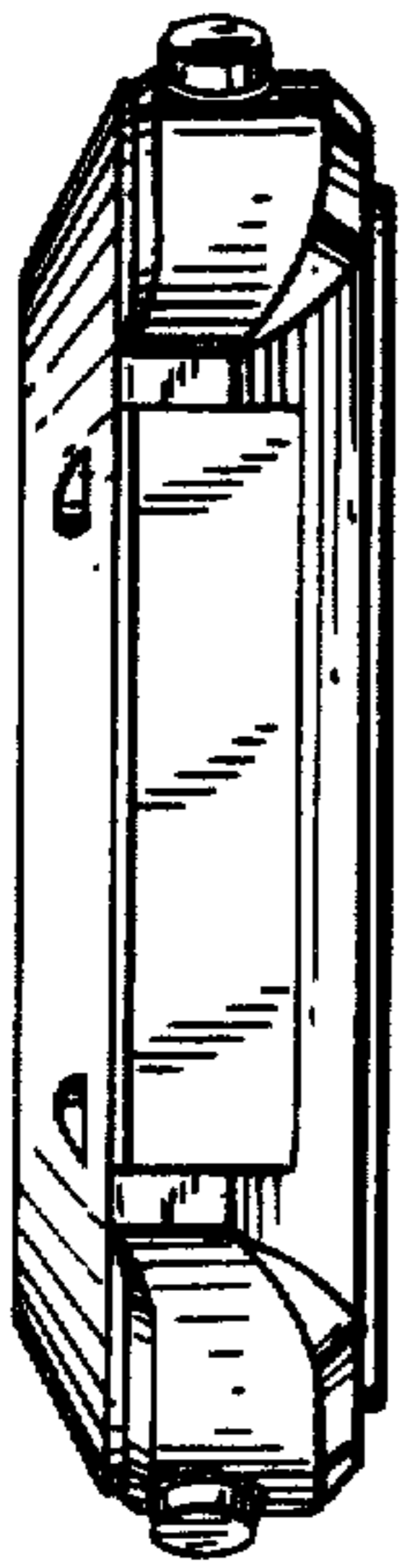

FIG. 2

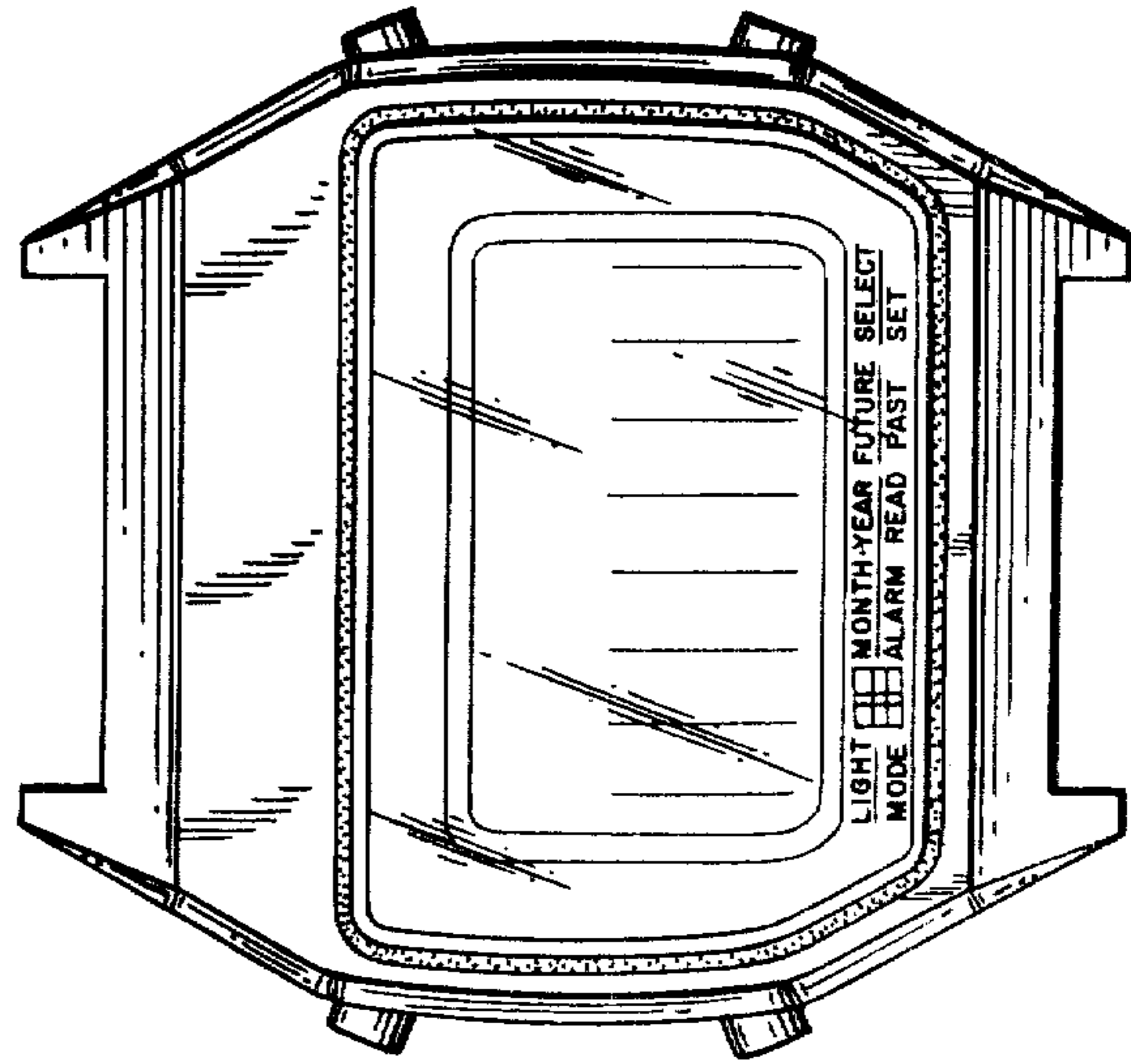

FIG. 3

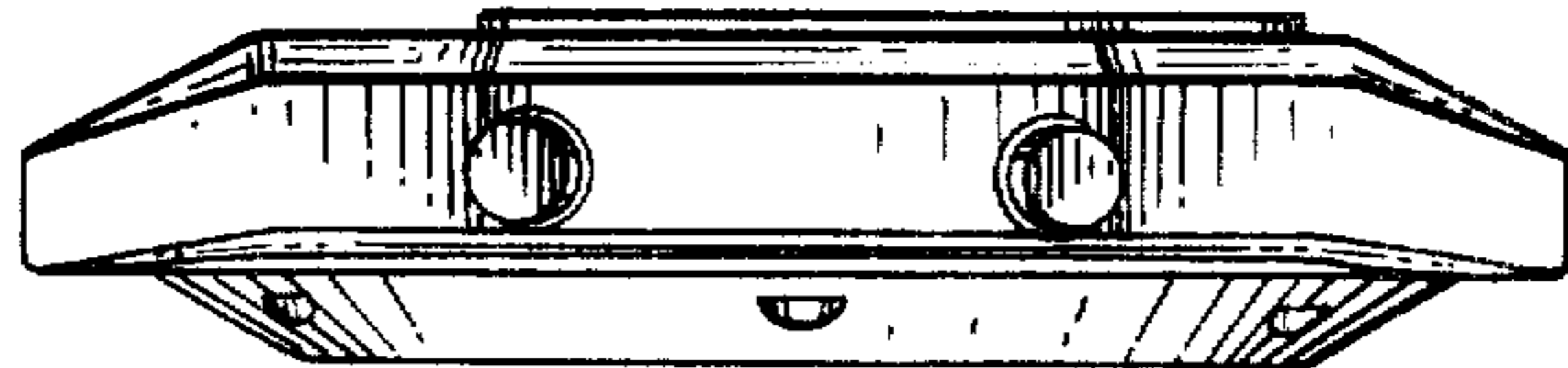

FIG. 4

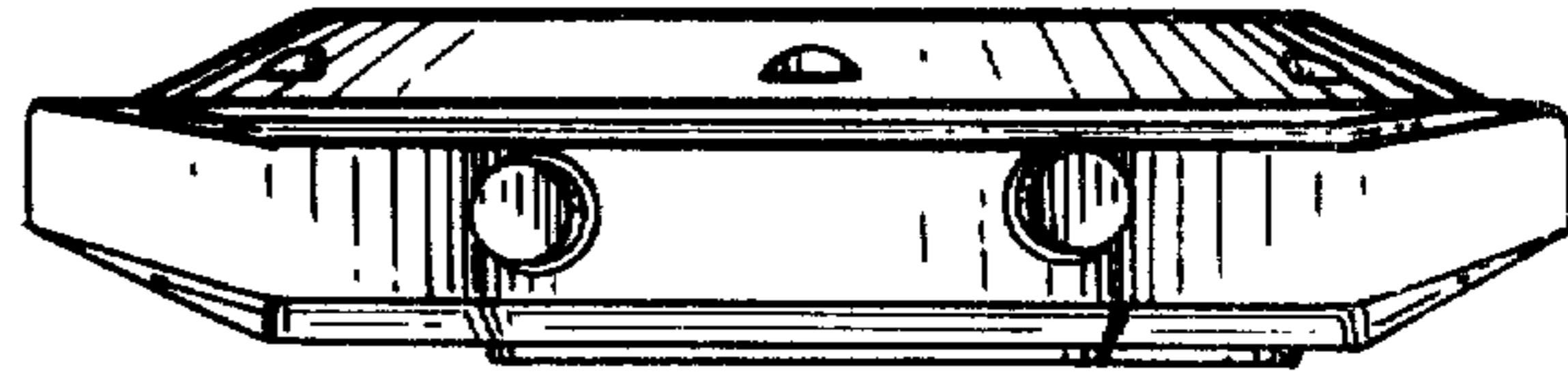

FIG. 5

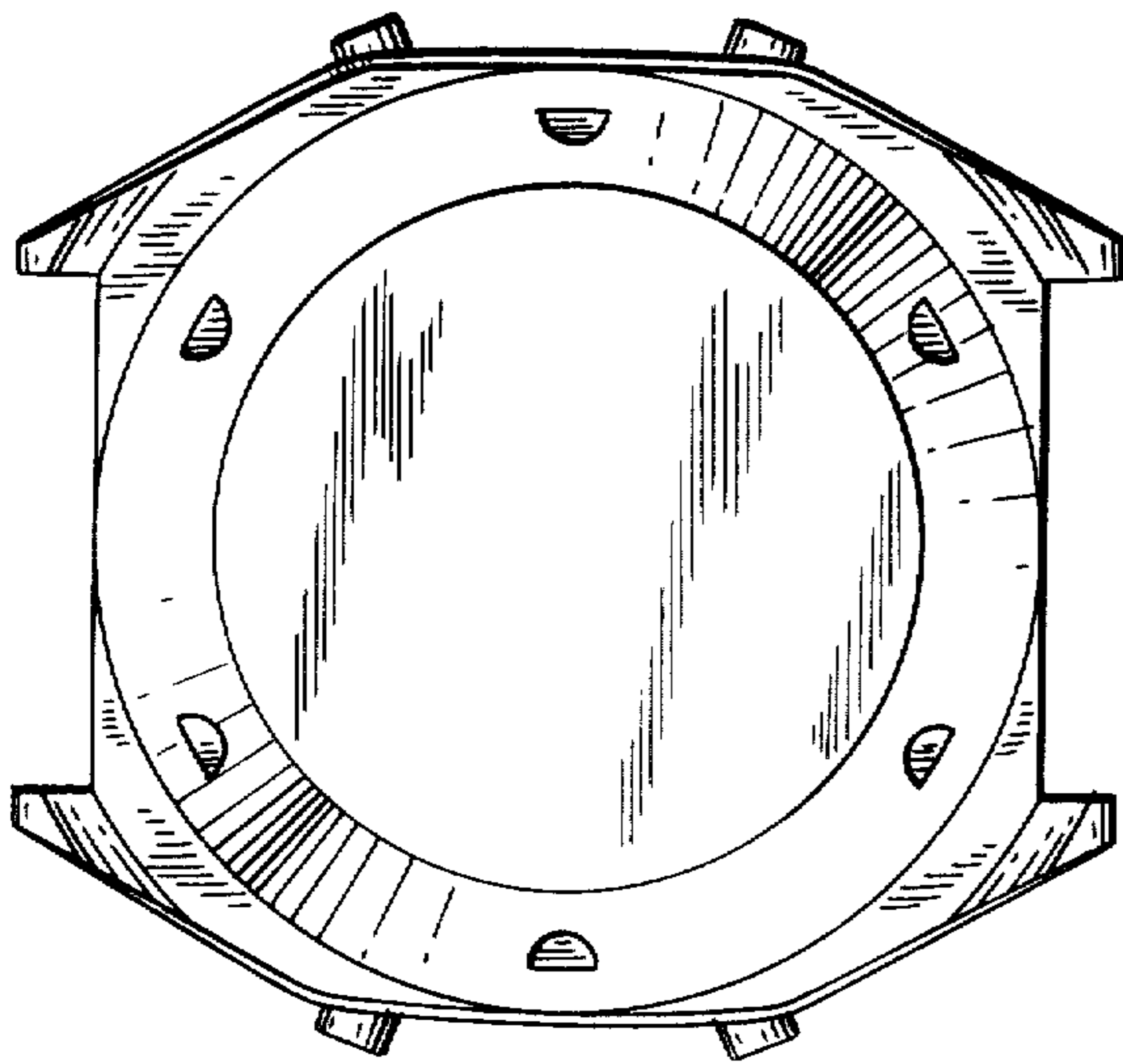

FIG. 7

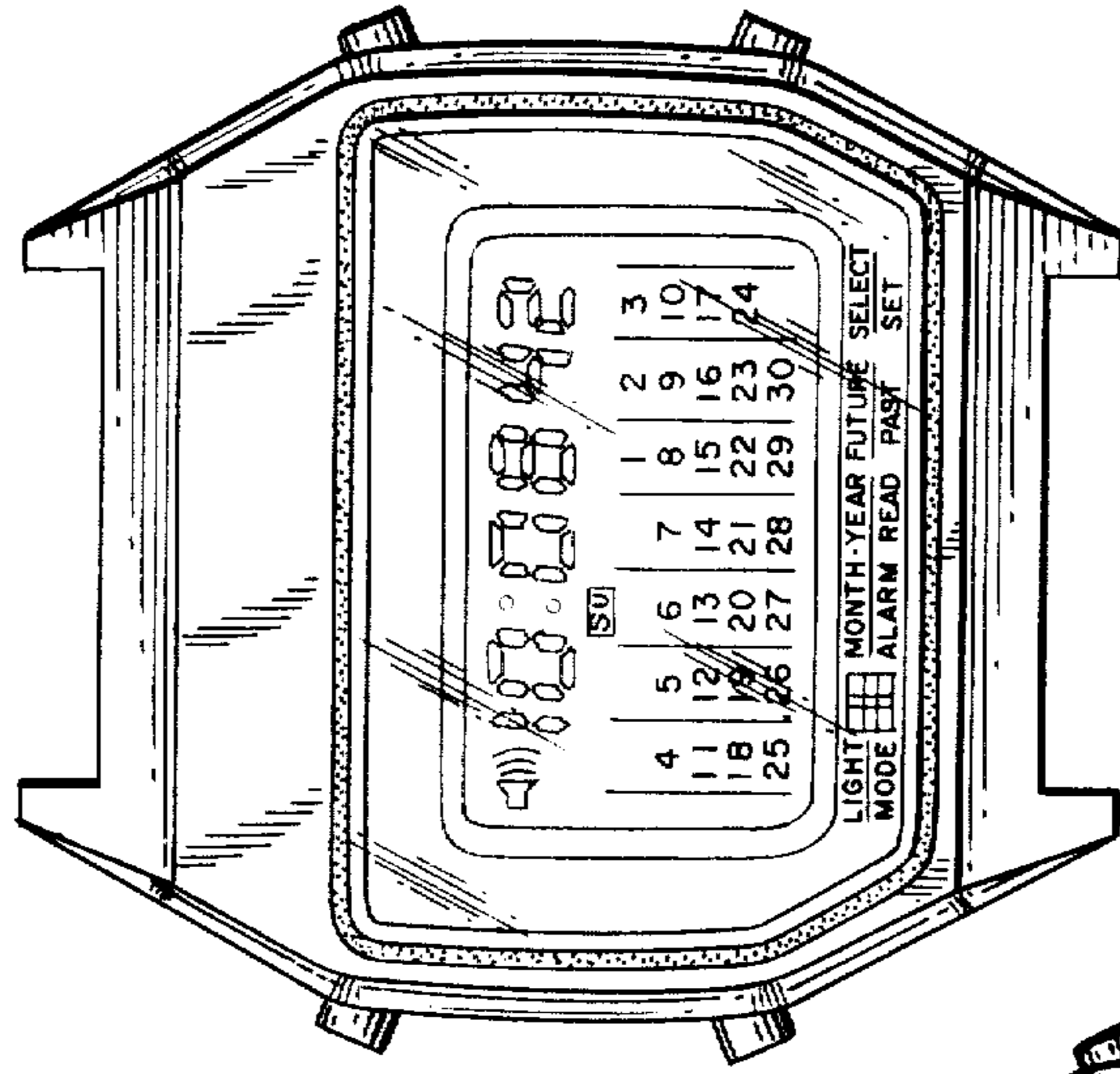

FIG. 6

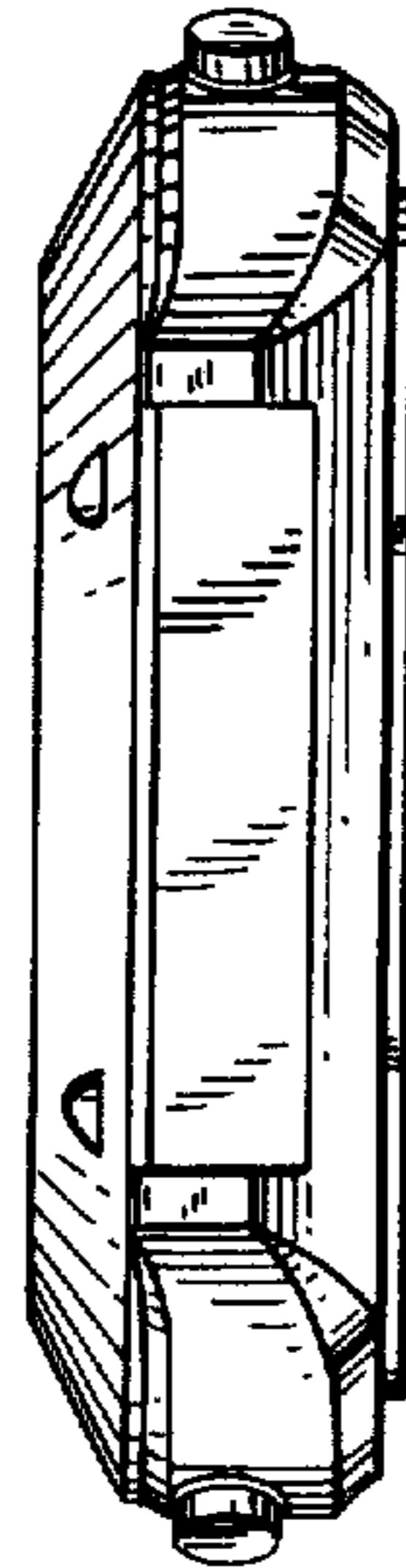

FIG. 8

