

[54] **CHILD'S OUTDOOR PLAY GYM**
 [75] Inventor: **Harold W. Carlson, Dothan, Ala.**
 [73] Assignee: **Brown Group Recreational Industries, Inc., Bedford, Pa.**
 [**] Term: **7 Years**
 [21] Appl. No.: **959,928**
 [22] Filed: **Nov. 13, 1978**
 [51] Int. Cl. **D21-03**
 [52] U.S. Cl. **D21/245; D21/246**
 [58] Field of Search **D21/242-246; 273/60, 113**

[56] **References Cited**
U.S. PATENT DOCUMENTS
 D. 146,557 4/1947 Cosme D21/246
 D. 160,320 10/1950 Horowitz D21/243

Primary Examiner—Melvin B. Feifer

Attorney, Agent, or Firm—Cesari and McKenna

[57] **CLAIM**
 The ornamental design for a child's outdoor play gym, substantially as shown and described.

DESCRIPTION
 FIG. 1 is a perspective view of a child's outdoor play gym embodying my new design;
 FIG. 2 is a front elevational view thereof;
 FIG. 3 is a top view thereof;
 FIG. 4 is an end view thereof;
 FIG. 5 is a view similar to FIG. 1 showing another embodiment of the gym;
 FIG. 6 is a front elevational view thereof;
 FIG. 7 is a top view thereof;
 FIG. 8 is an end view thereof;
 FIG. 9 is a top view of a further gym embodiment;
 FIG. 10 is an end view thereof;
 The sides and ends of the gym not shown are mirror images of the sides and ends shown.

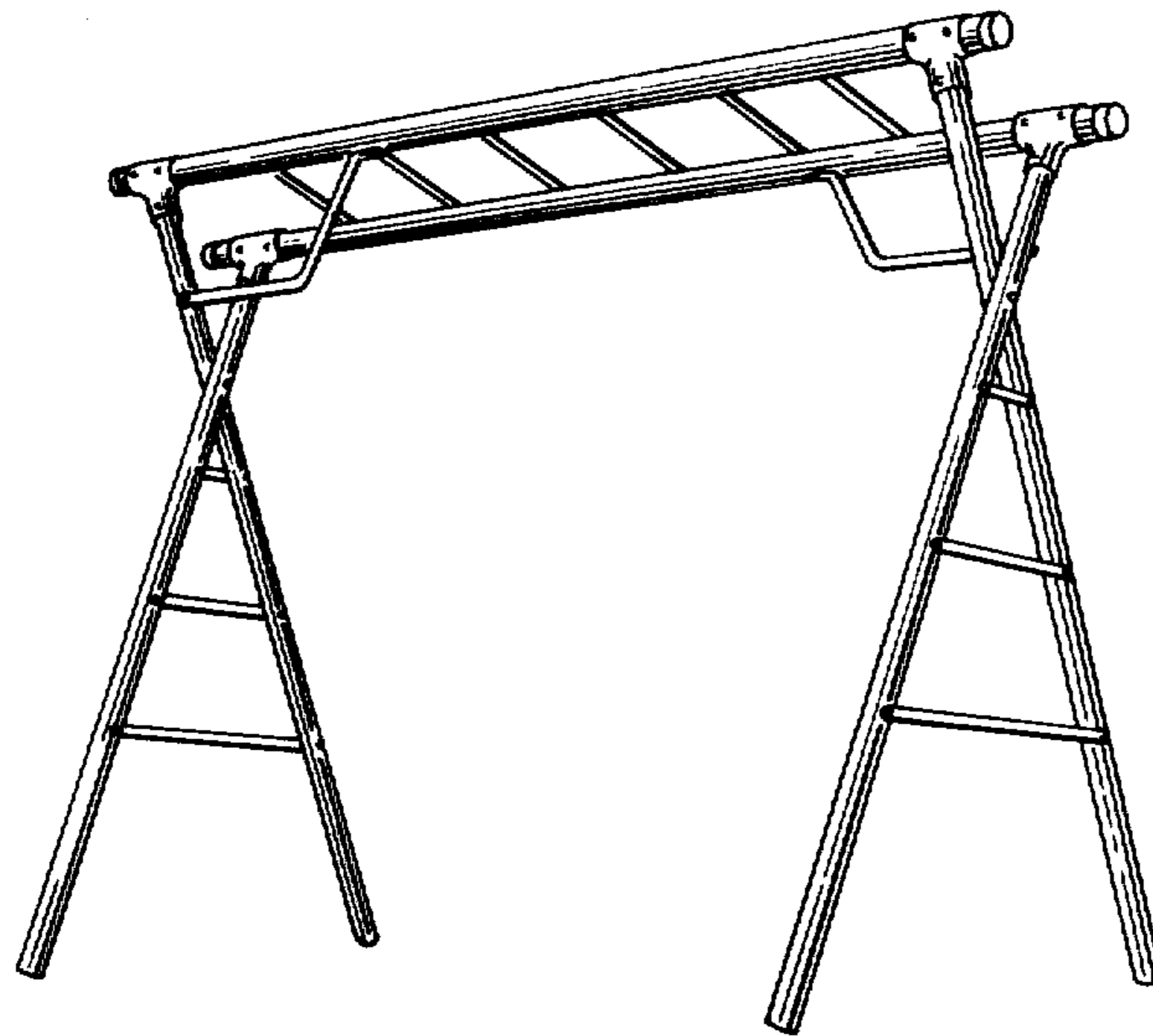

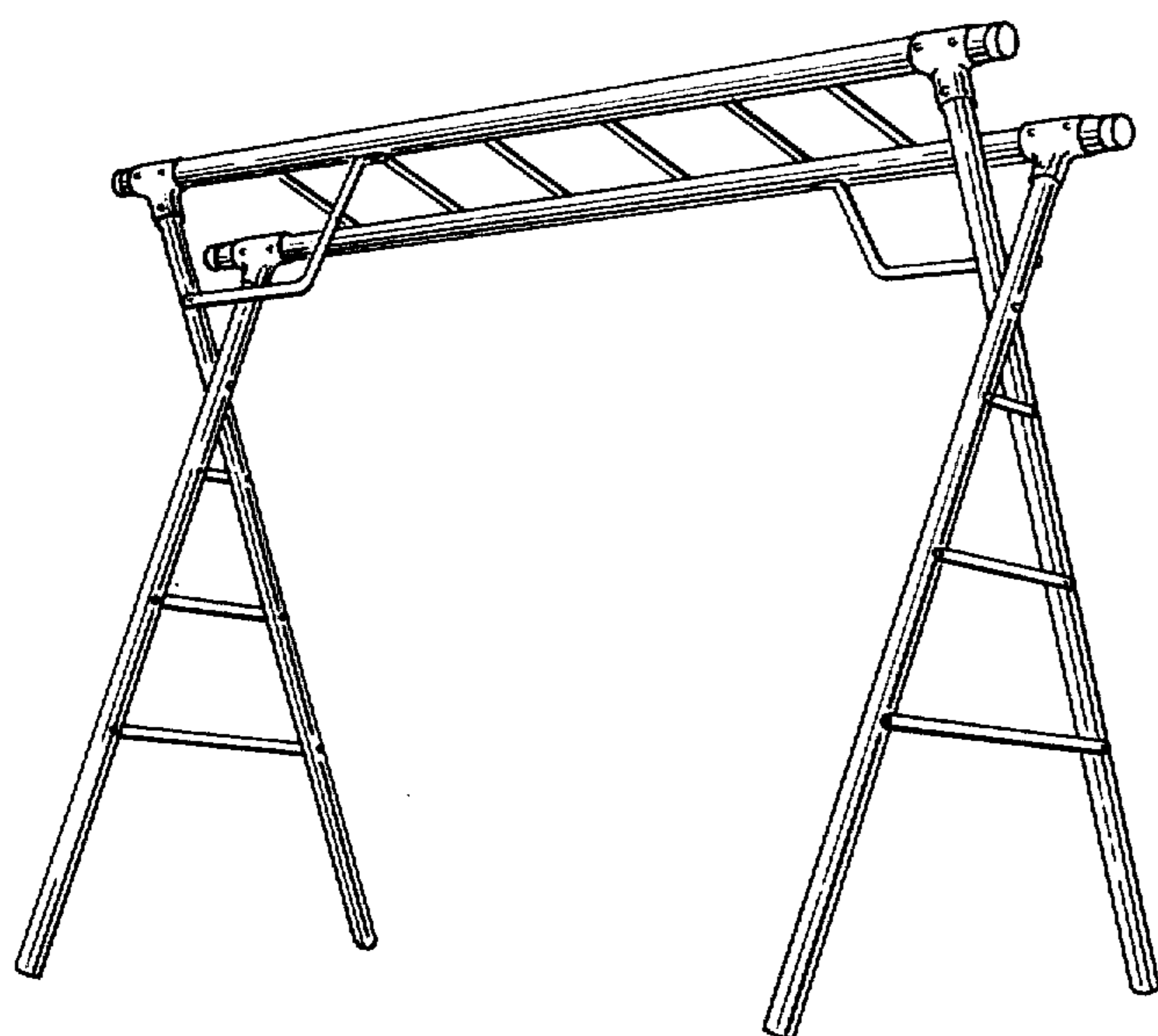

FIG. 1

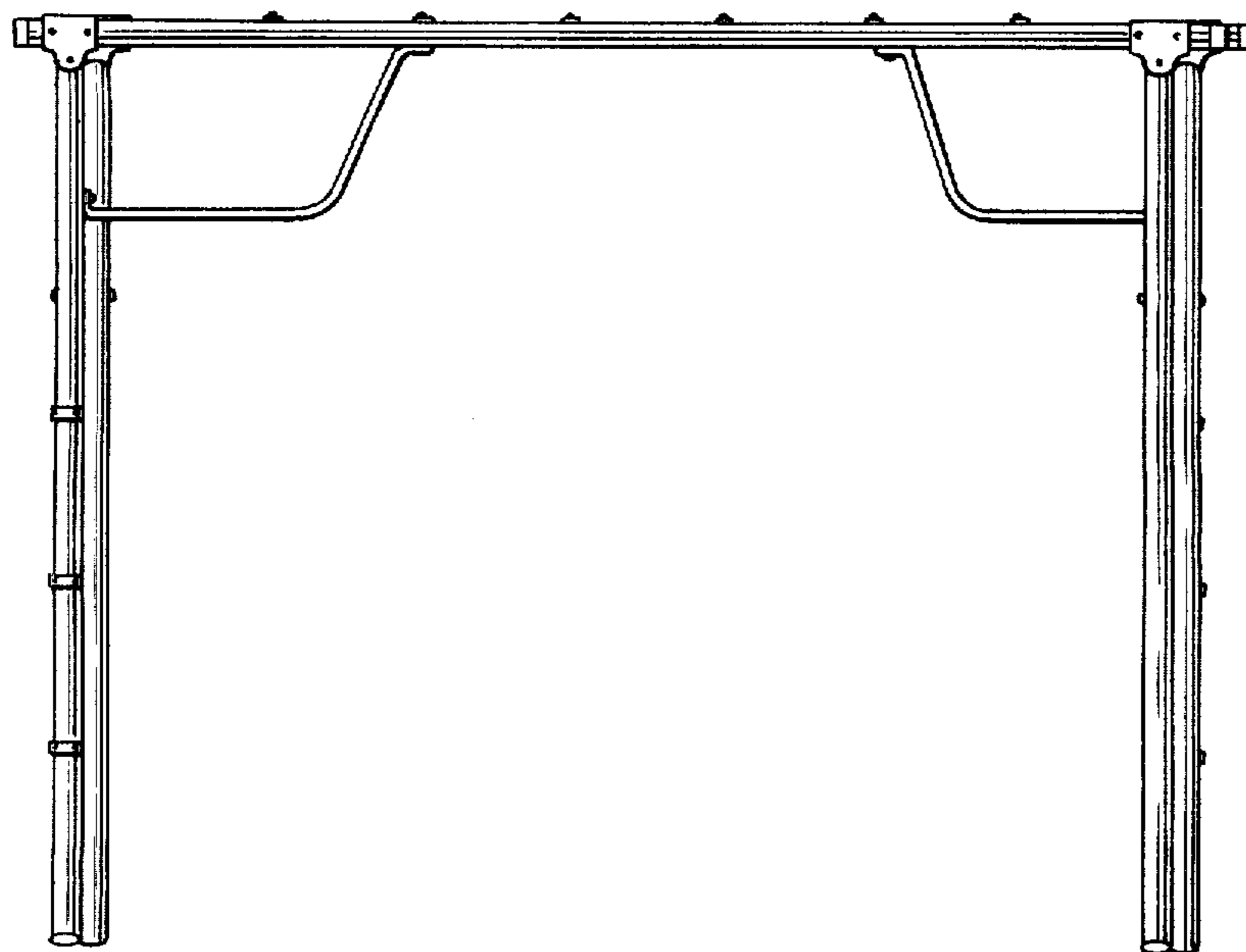

FIG. 2

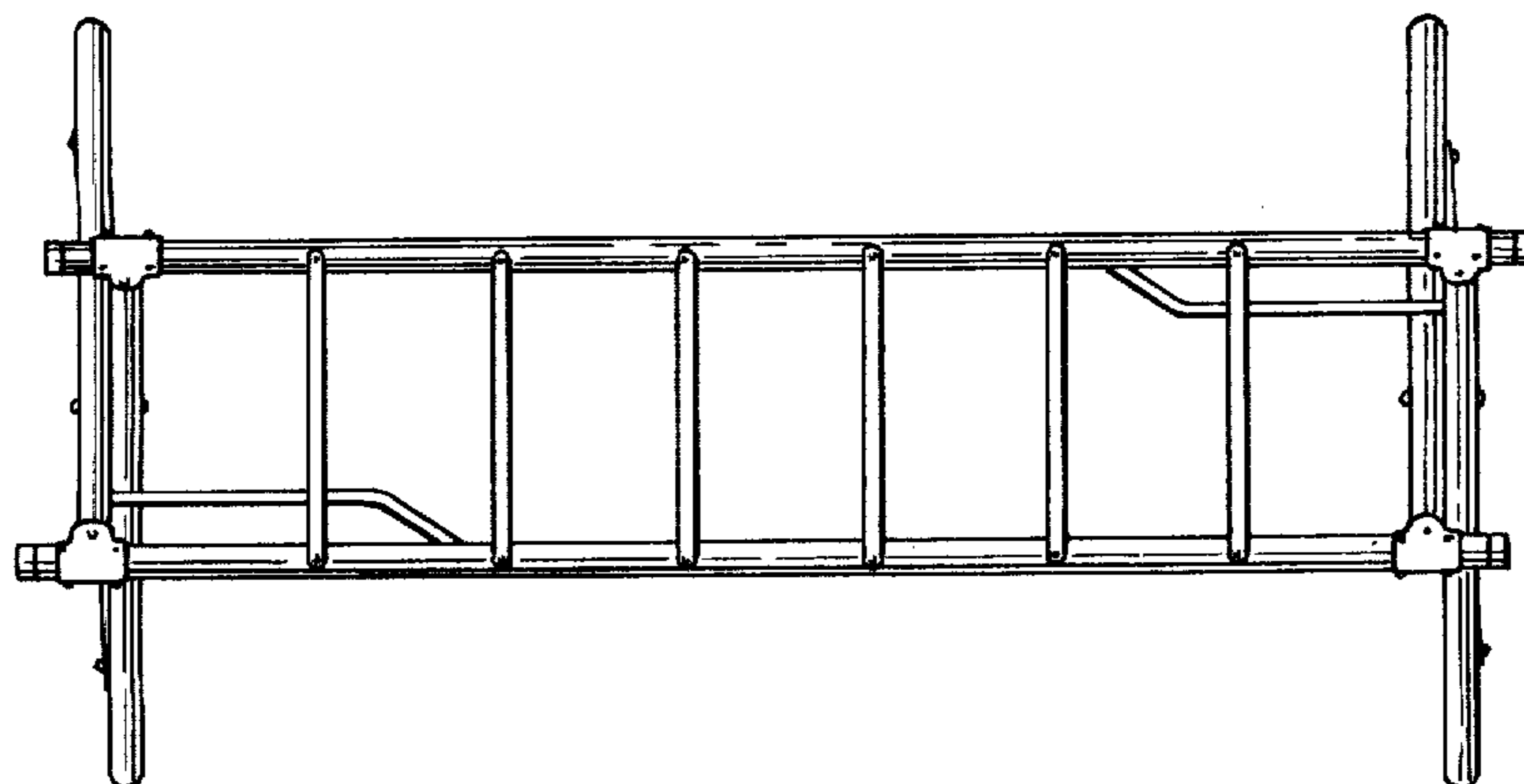

FIG. 3

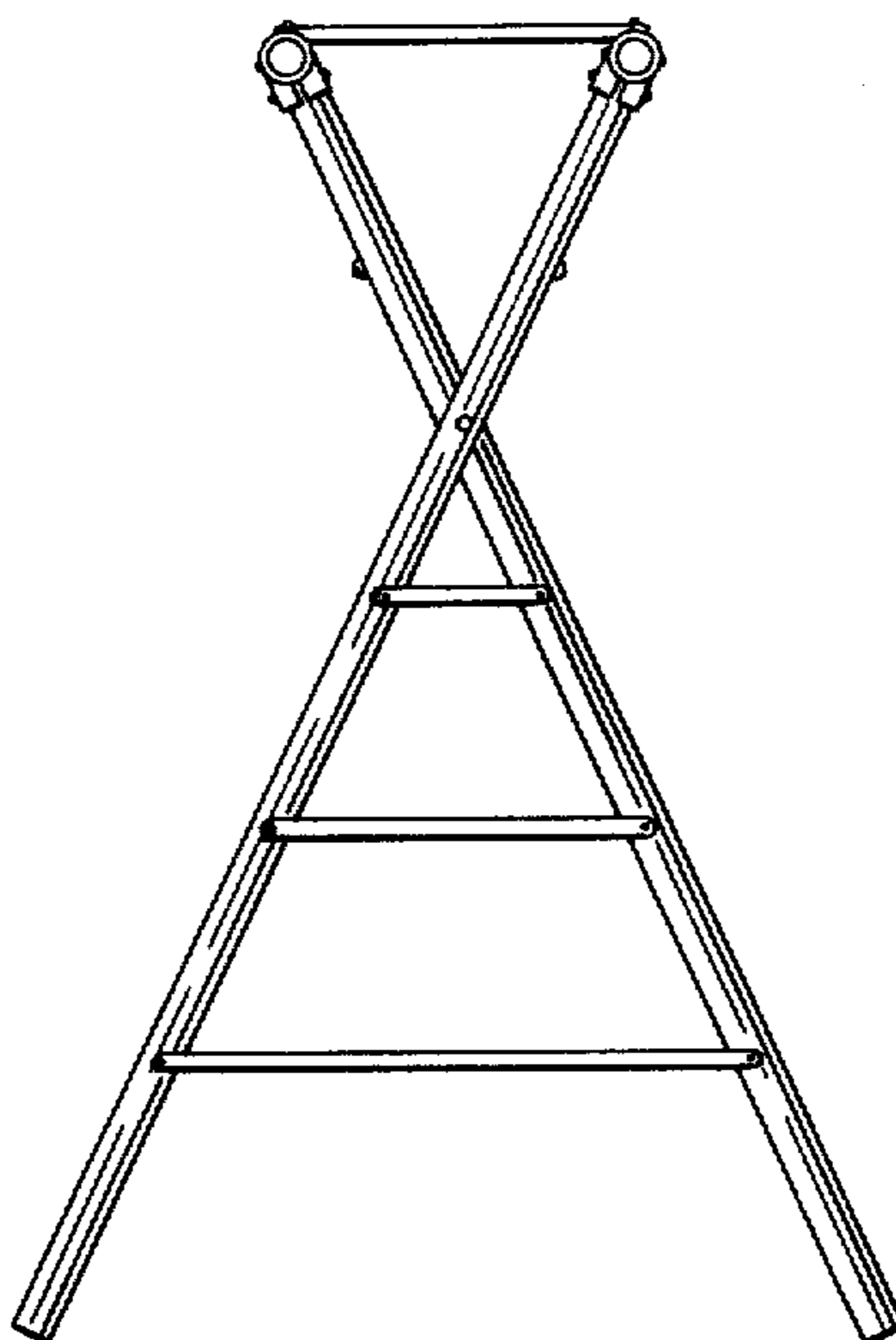

FIG. 4



FIG. 5

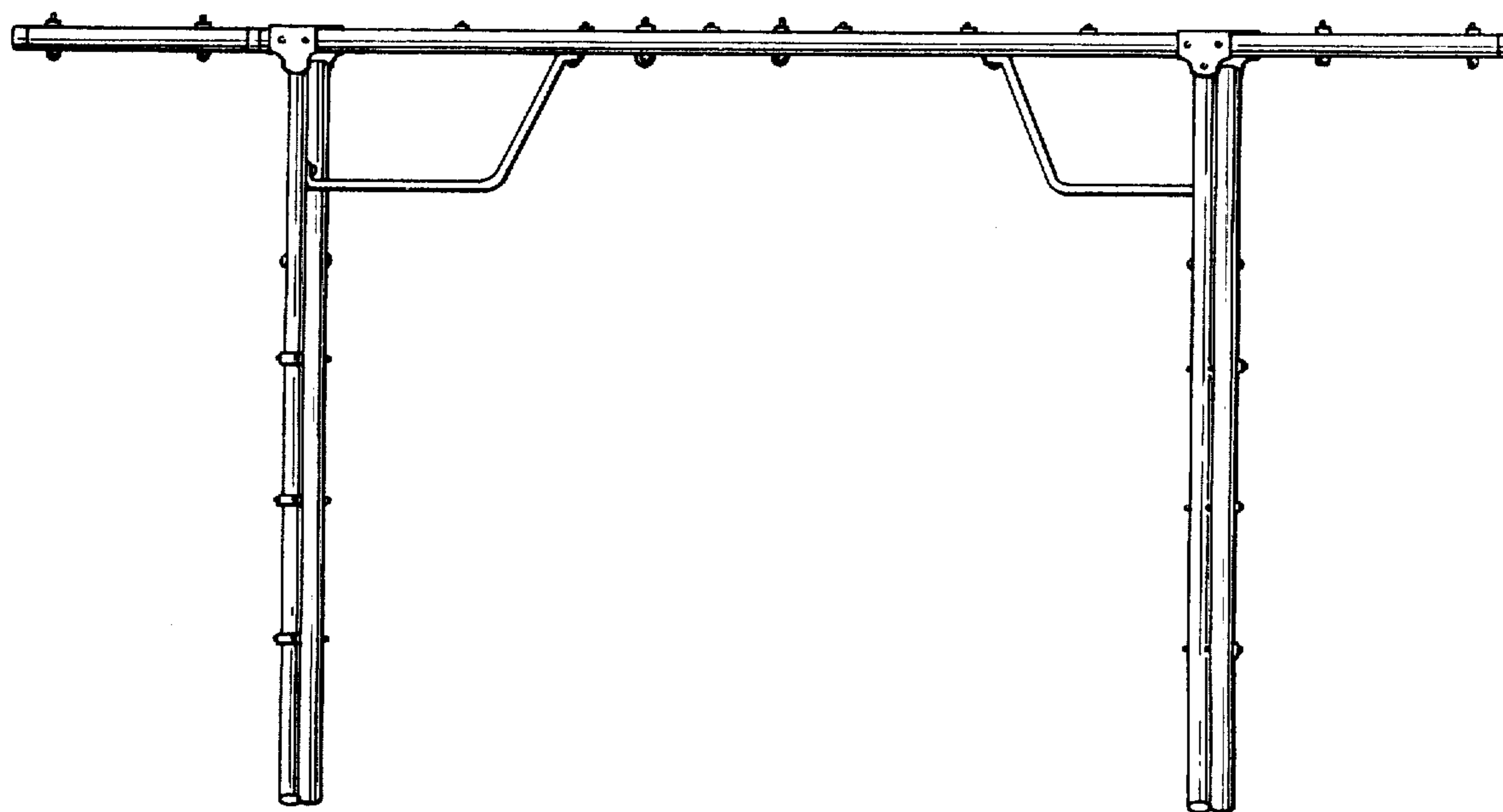

FIG. 6

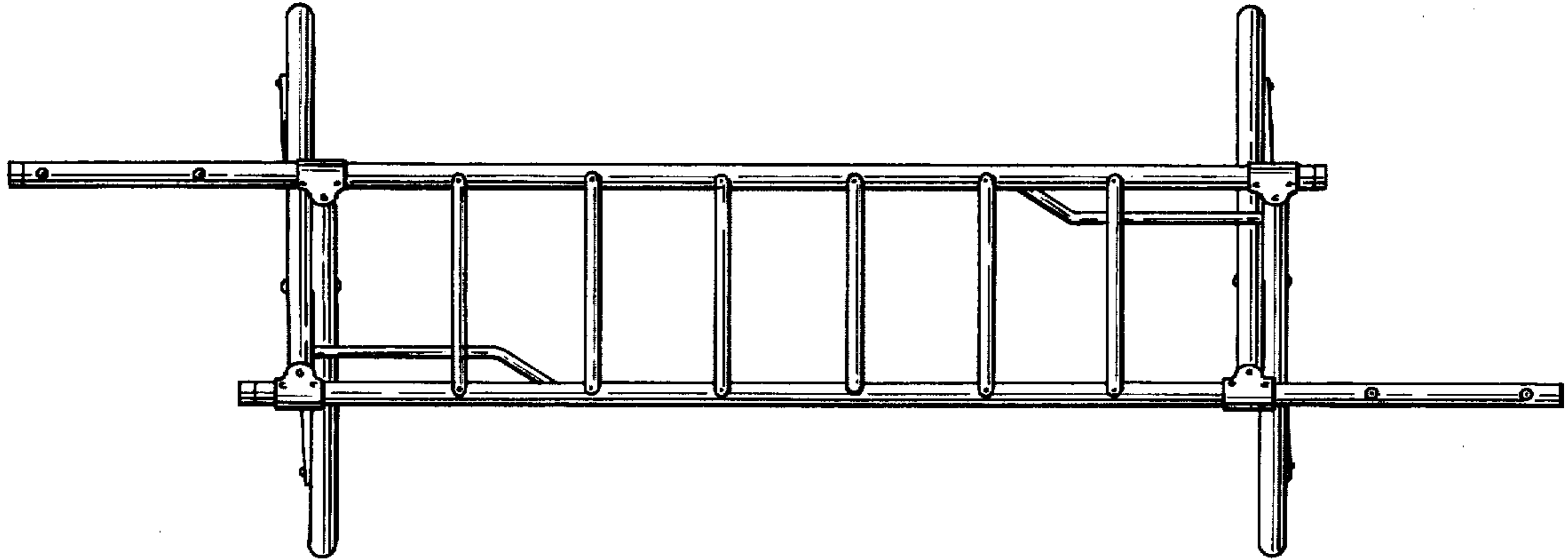

FIG. 7

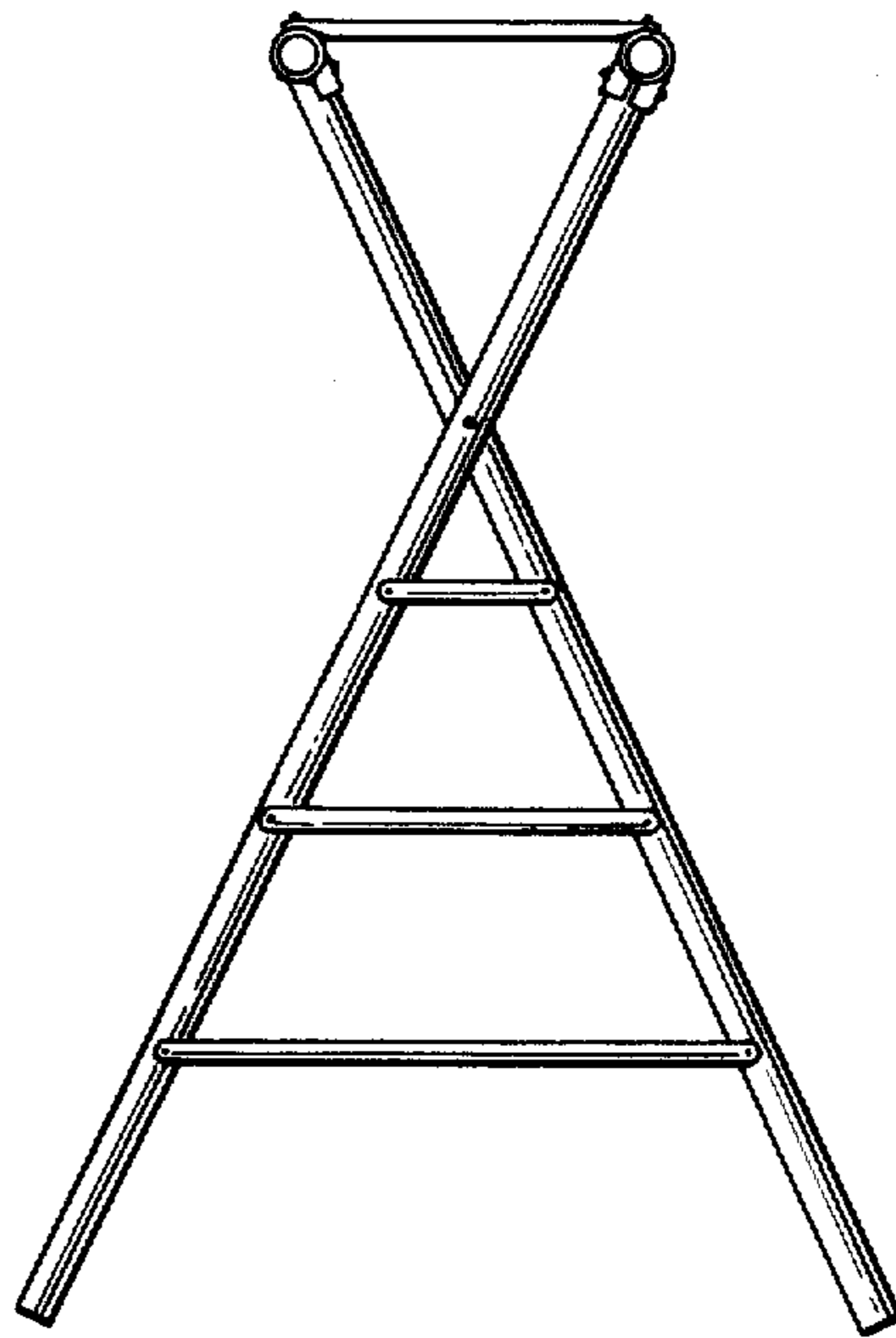

FIG. 8

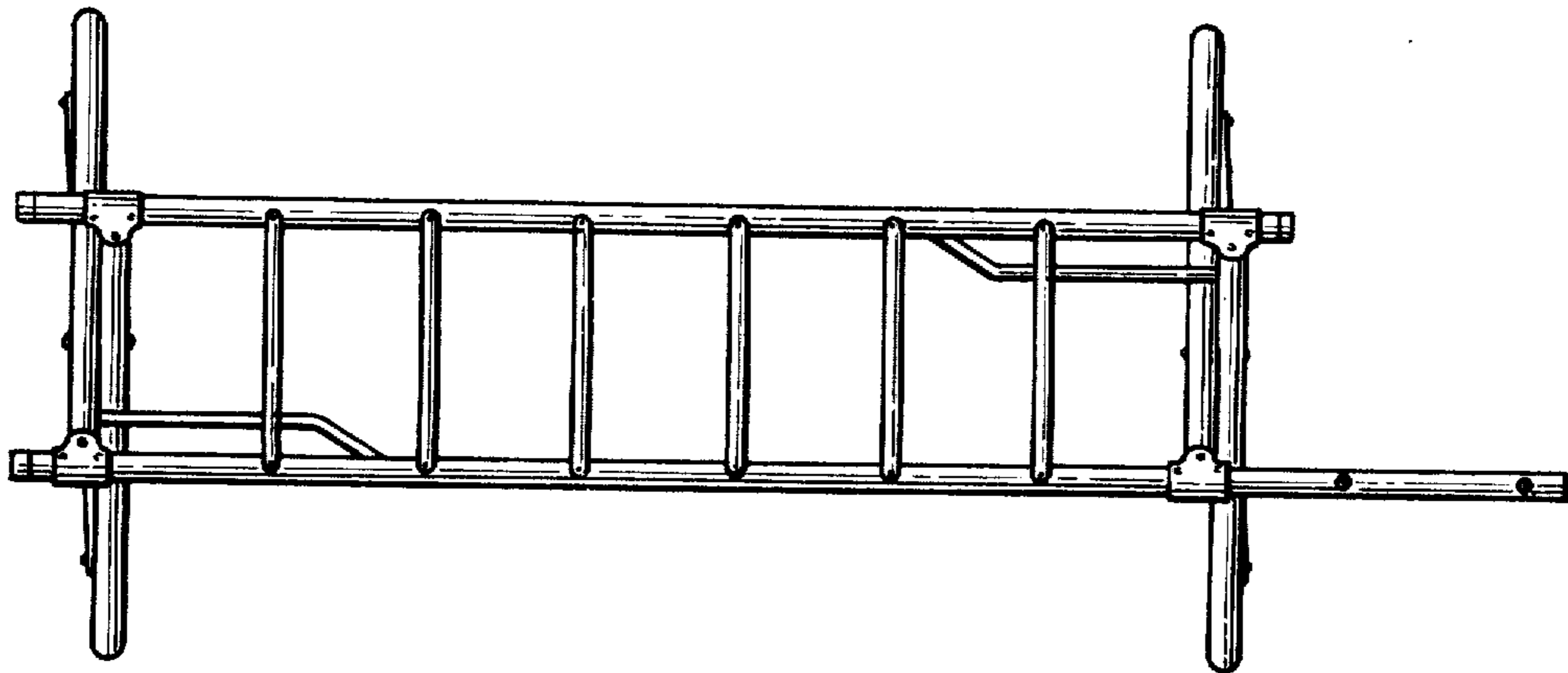

FIG. 9

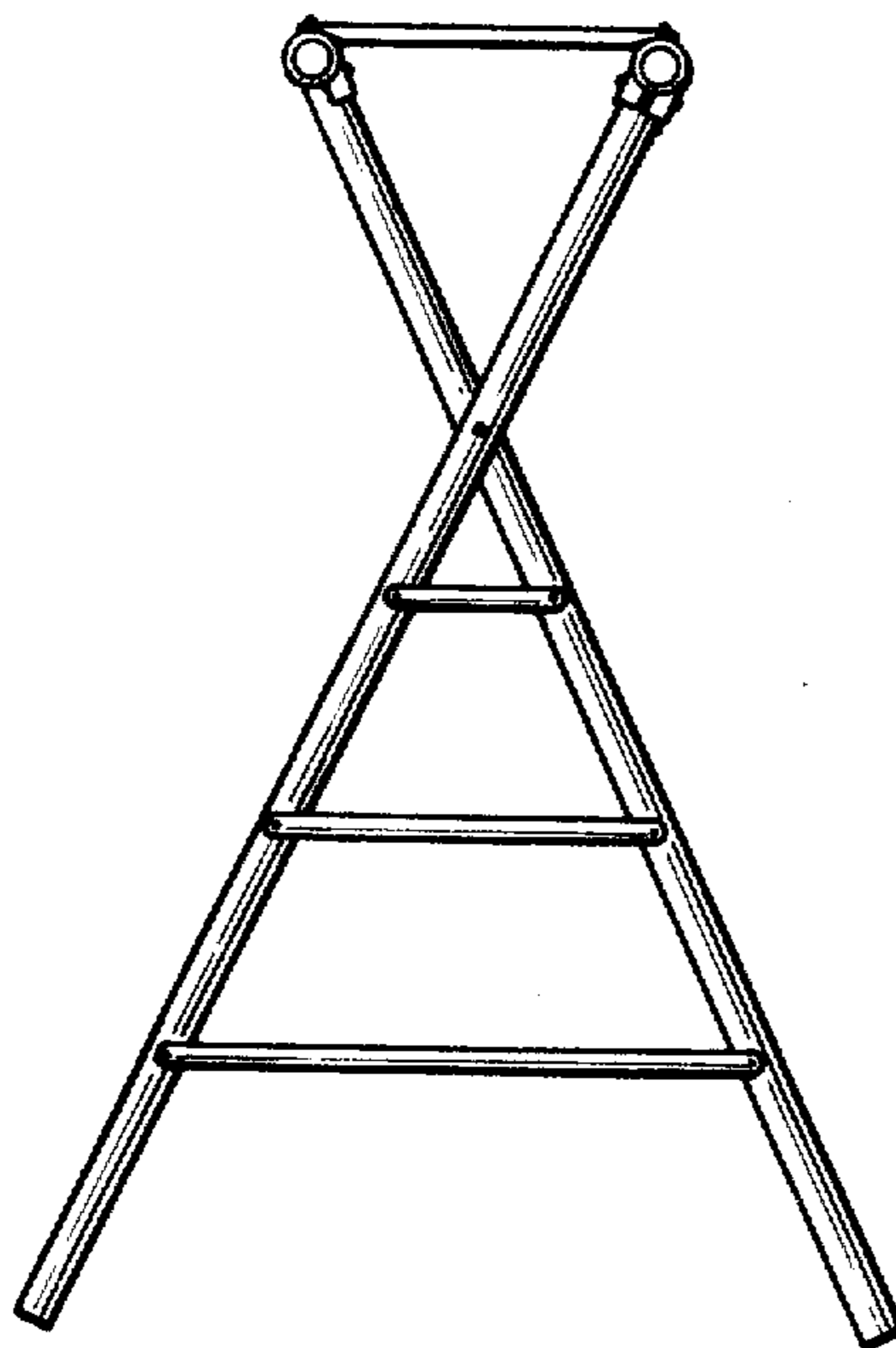

FIG. 10

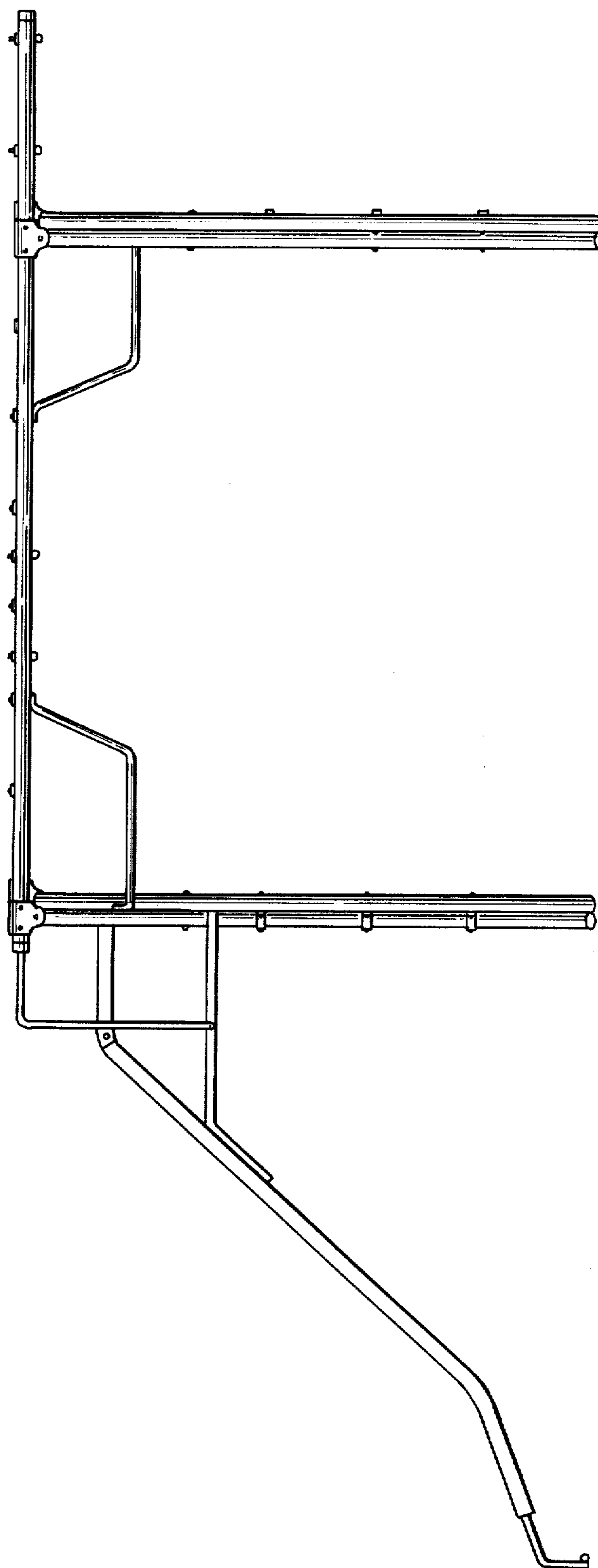

FIG. 11

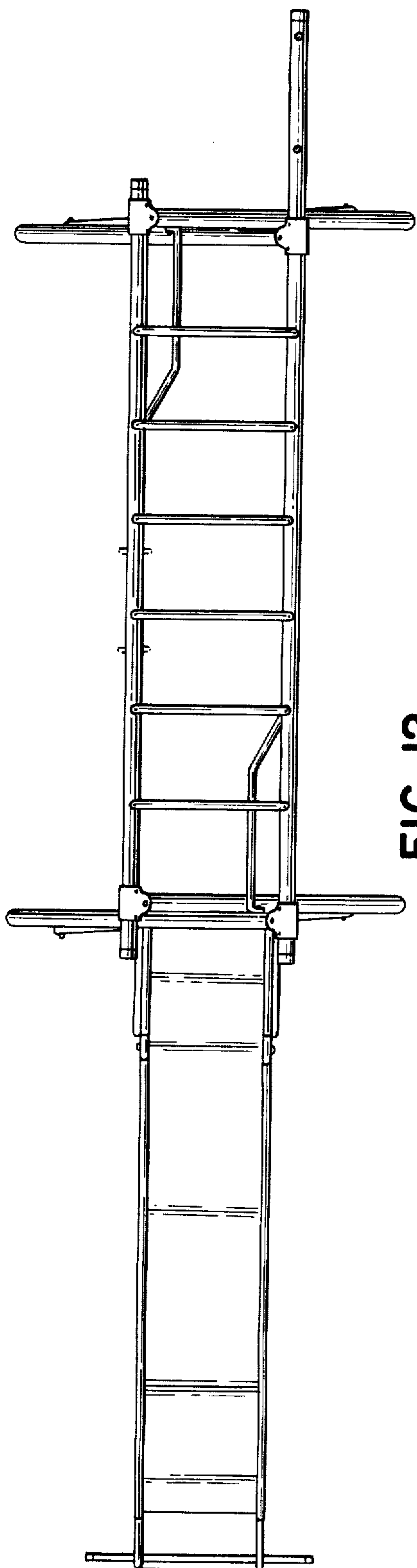

FIG. 12

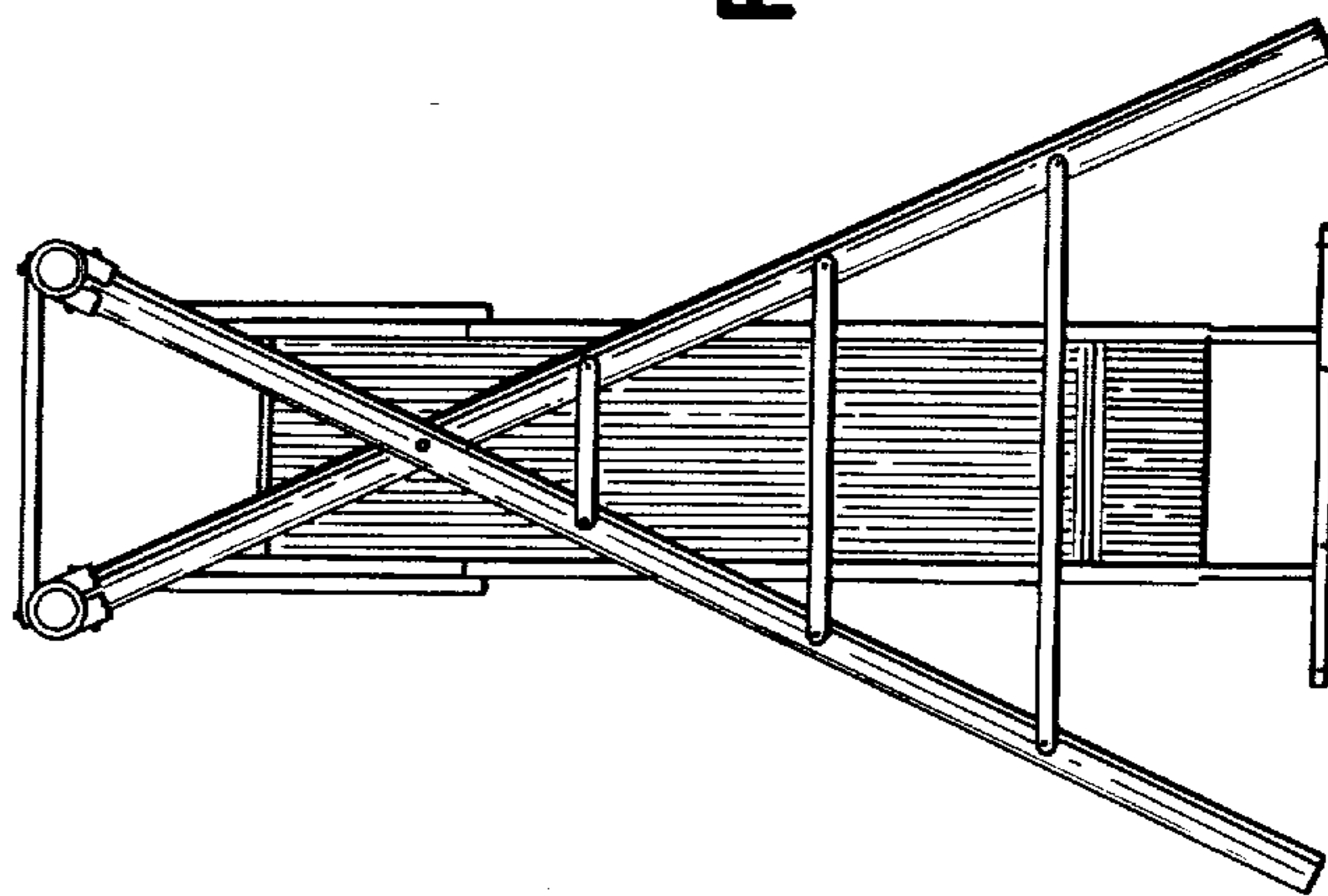

FIG. 14

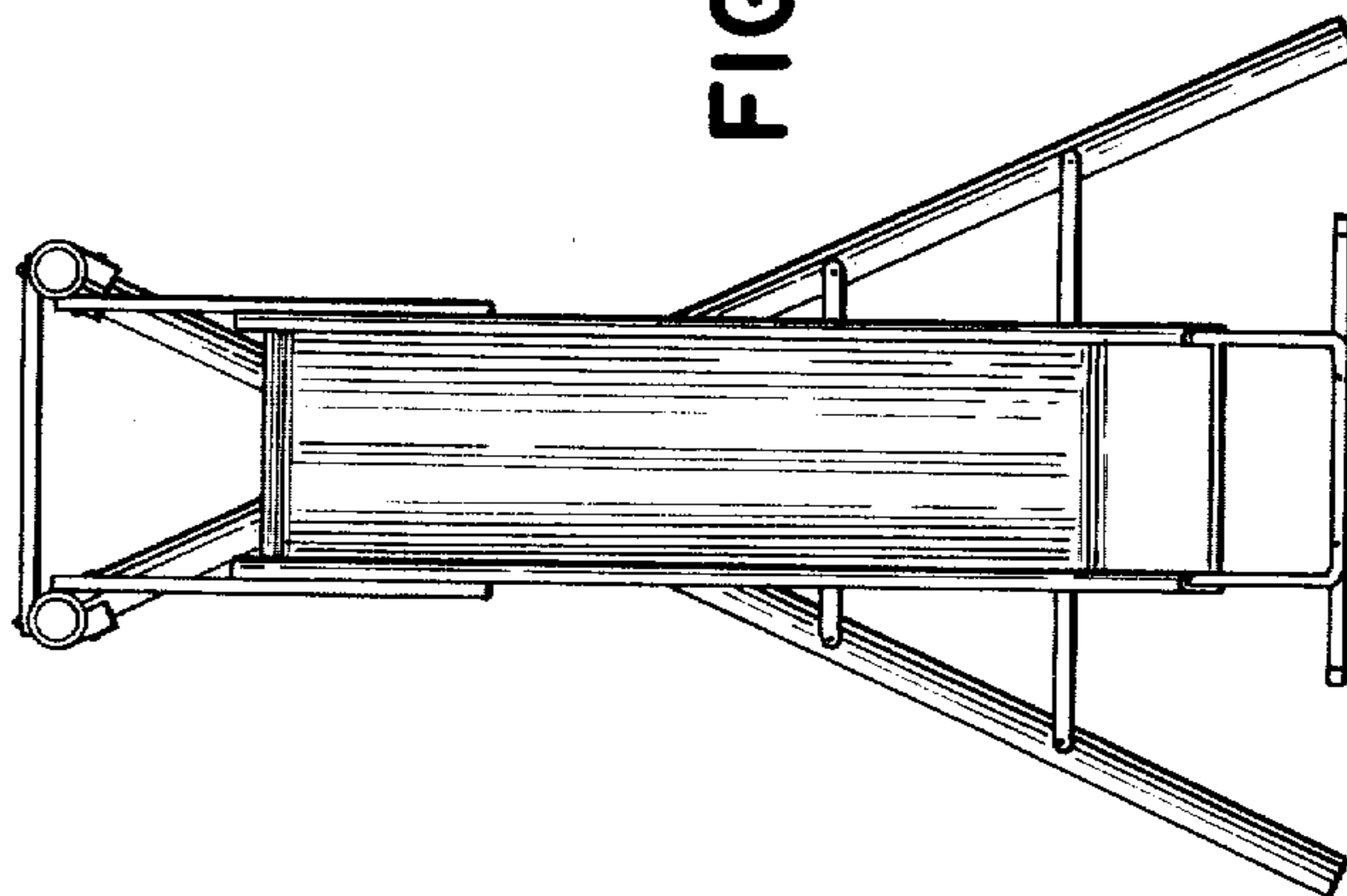

FIG. 13

UNITED STATES PATENT AND TRADEMARK OFFICE
CERTIFICATE OF CORRECTION

PATENT NO. : Des. 263,983
DATED : April 20, 1982
INVENTOR(S) : Harold W. Carlson

It is certified that error appears in the above-identified patent and that said Letters Patent is hereby corrected as shown below:

In the drawings,
Delete FIGS. 11 through 14.

Signed and Sealed this
Seventeenth Day of May 1983

[SEAL]

Attest:

DONALD J. QUIGG

Attesting Officer

Acting Commissioner of Patents and Trademarks