

[54] **FACSIMILE RECORDER AND TRANSCEIVER**
[75] Inventors: **Nobuki Matsumoto; Manzo Yoshihama**, both of Yokohama; **Fumiyo Kojima**, Hiratsuka, all of Japan
[73] Assignee: **Ricoh Company, Ltd.**, Tokyo, Japan
[**] Term: **7 Years**
[21] Appl. No.: **156,637**
[22] Filed: **Jun. 4, 1980**

[30] **Foreign Application Priority Data**
Dec. 6, 1979 [JP] Japan 54-51018

[51] **Int. Cl.** **D14-01**
[52] **U.S. Cl.** **D14/94**
[58] **Field of Search** **D14/1, 3, 93-95, D14/99; D16/30, 31; 358/256, 286**

[56] **References Cited**
U.S. PATENT DOCUMENTS
D. 200,129 1/1965 Plantholt D16/30
D. 221,356 8/1971 Penney D16/31
D. 227,122 6/1973 Clowe D14/94

4,005,257 1/1977 Krallinger et al. 358/256

OTHER PUBLICATIONS

Mitsubishi Denki Giho: vol. 53, #10, 10-79, "The Melfas-510 . . . Facsimile Transceiver," p. 759, Illustration #1, Melfas 510.

Primary Examiner—Jane E. Corrigan
Attorney, Agent, or Firm—Wyatt, Gerber, Shoup, Scobey & Badie

[57] **CLAIM**

The ornamental design for a facsimile recorder and transceiver, as shown and described.

DESCRIPTION

FIG. 1 is a front, top and left side perspective view of a facsimile recorder and transceiver showing our new design;
FIG. 2 is a front elevational view thereof;
FIG. 3 is a top plan view thereof;
FIG. 4 is a right side elevational view thereof;
FIG. 5 is a left side elevational view thereof;
FIG. 6 is a rear elevational view thereof;
FIG. 7 is a bottom plan view thereof; and
FIG. 8 is a view like FIG. 1 with two document trays attached.

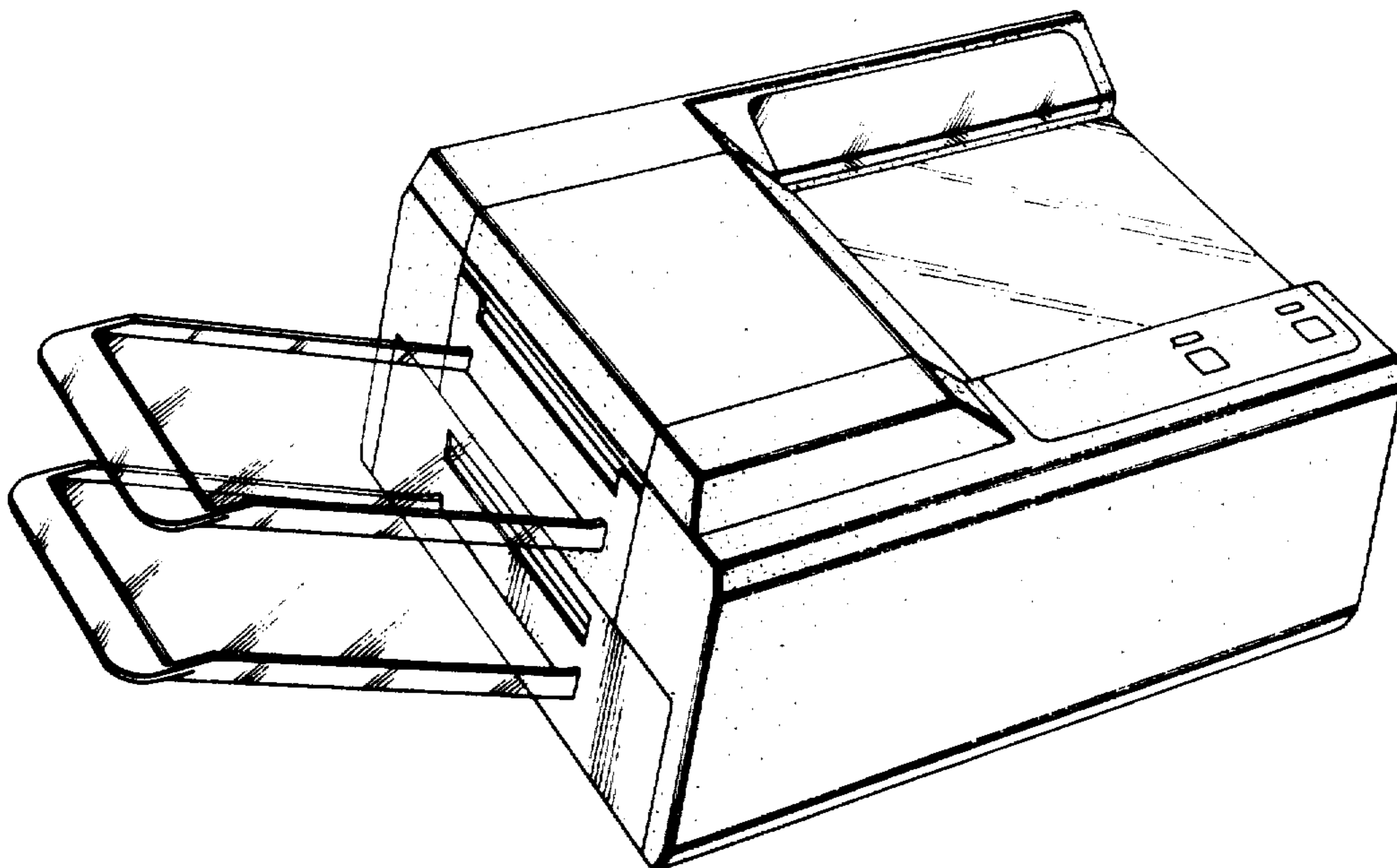

FIG. 1

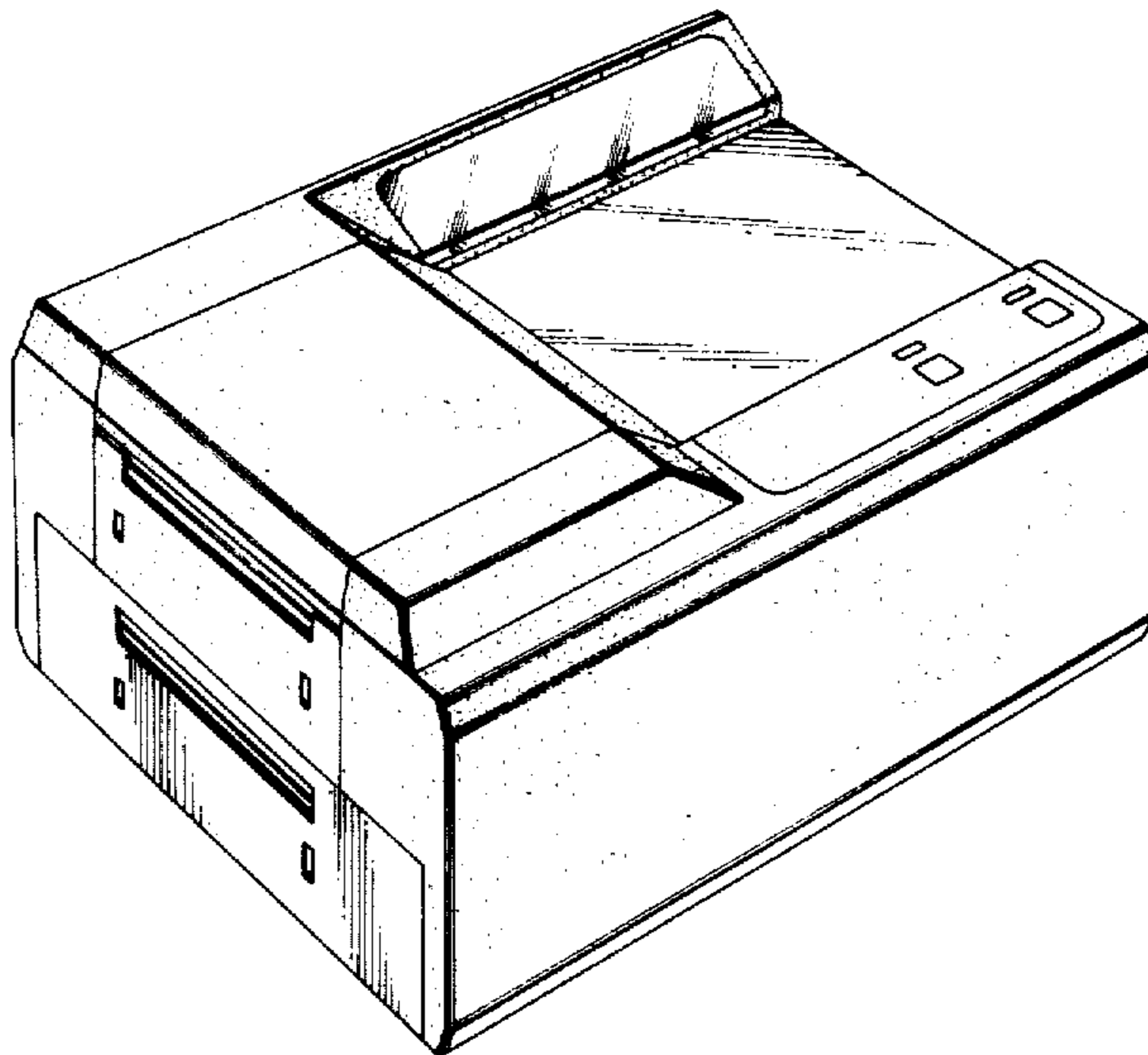

FIG. 2

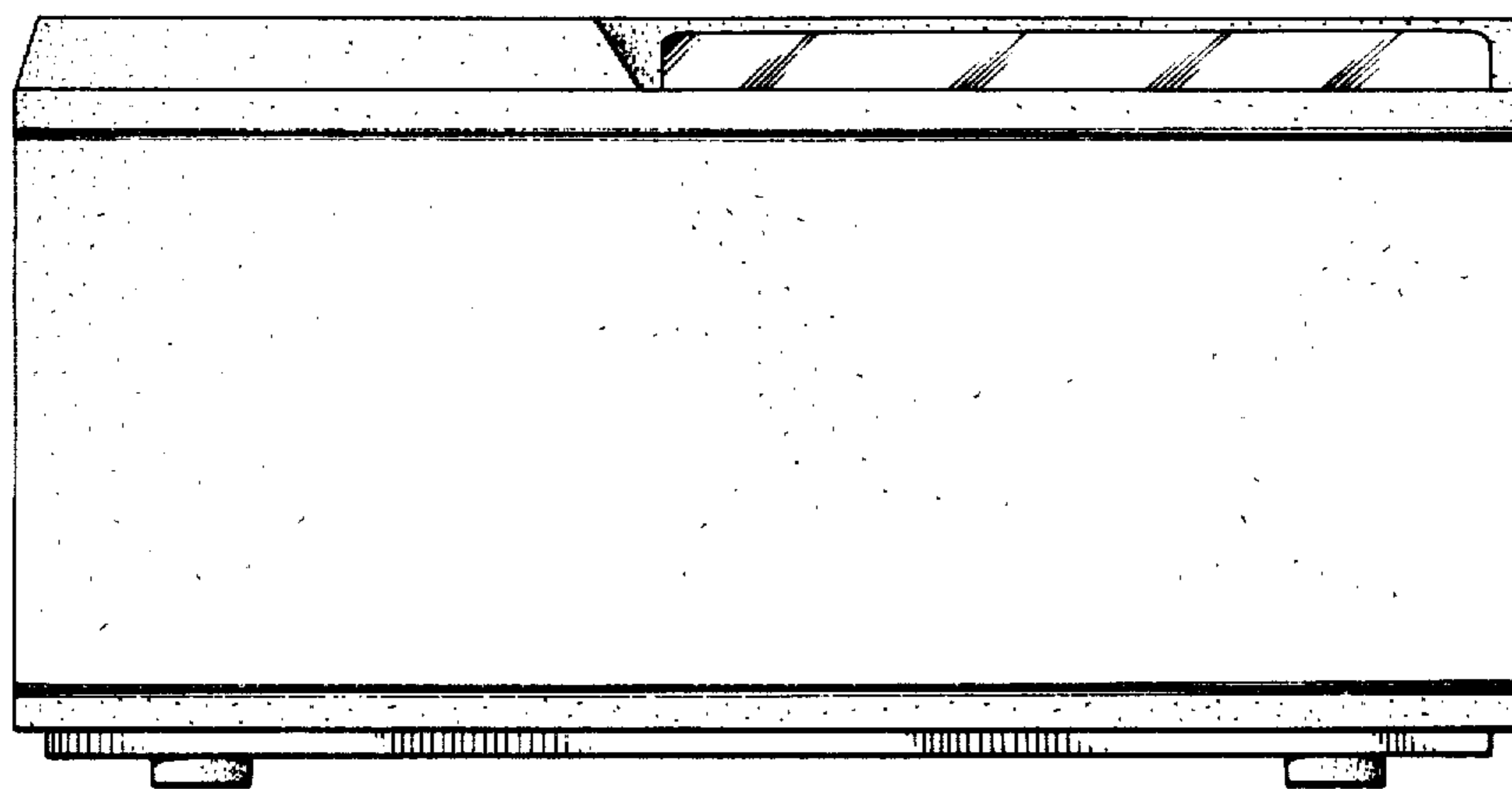

FIG. 3

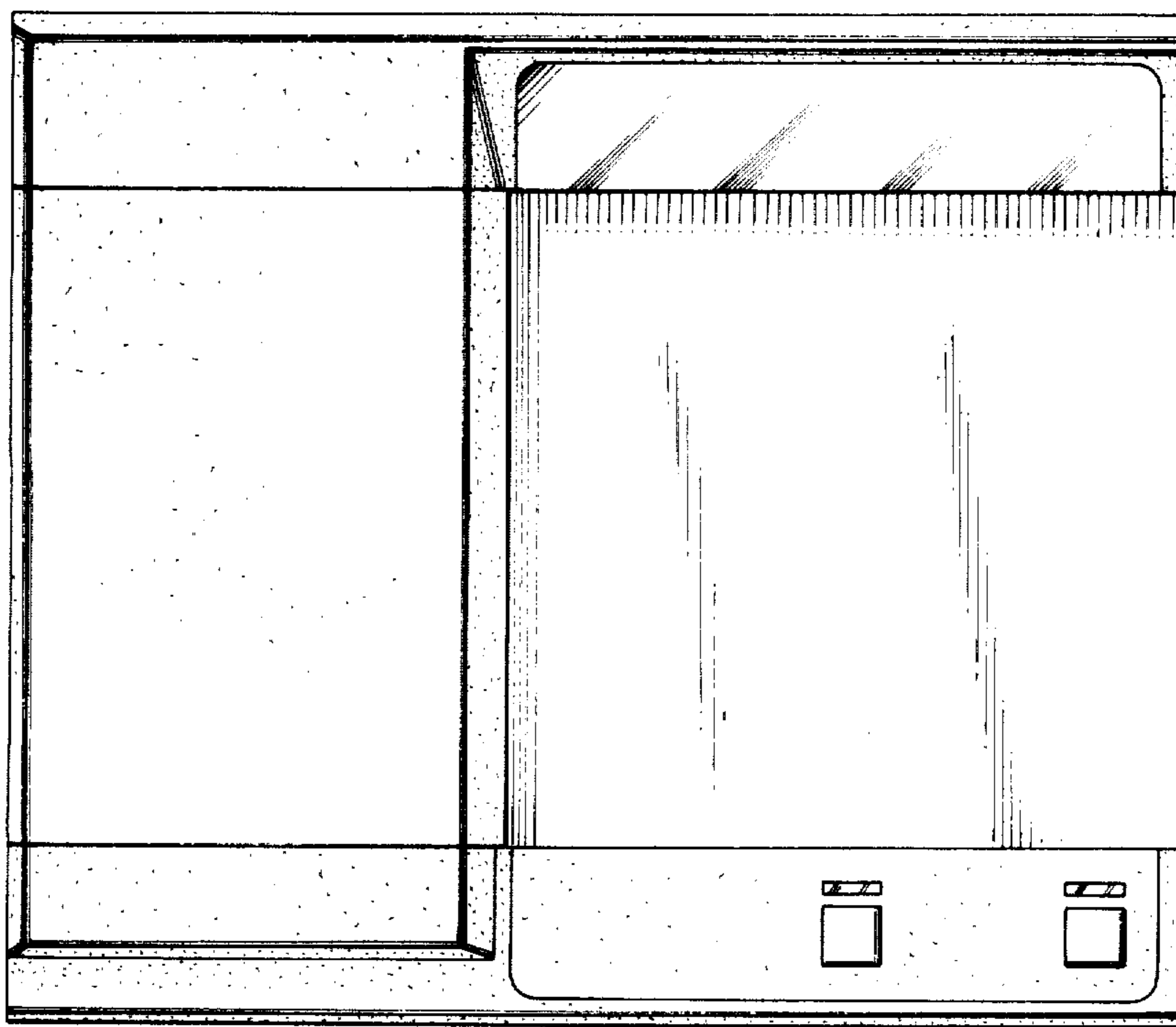

FIG. 4

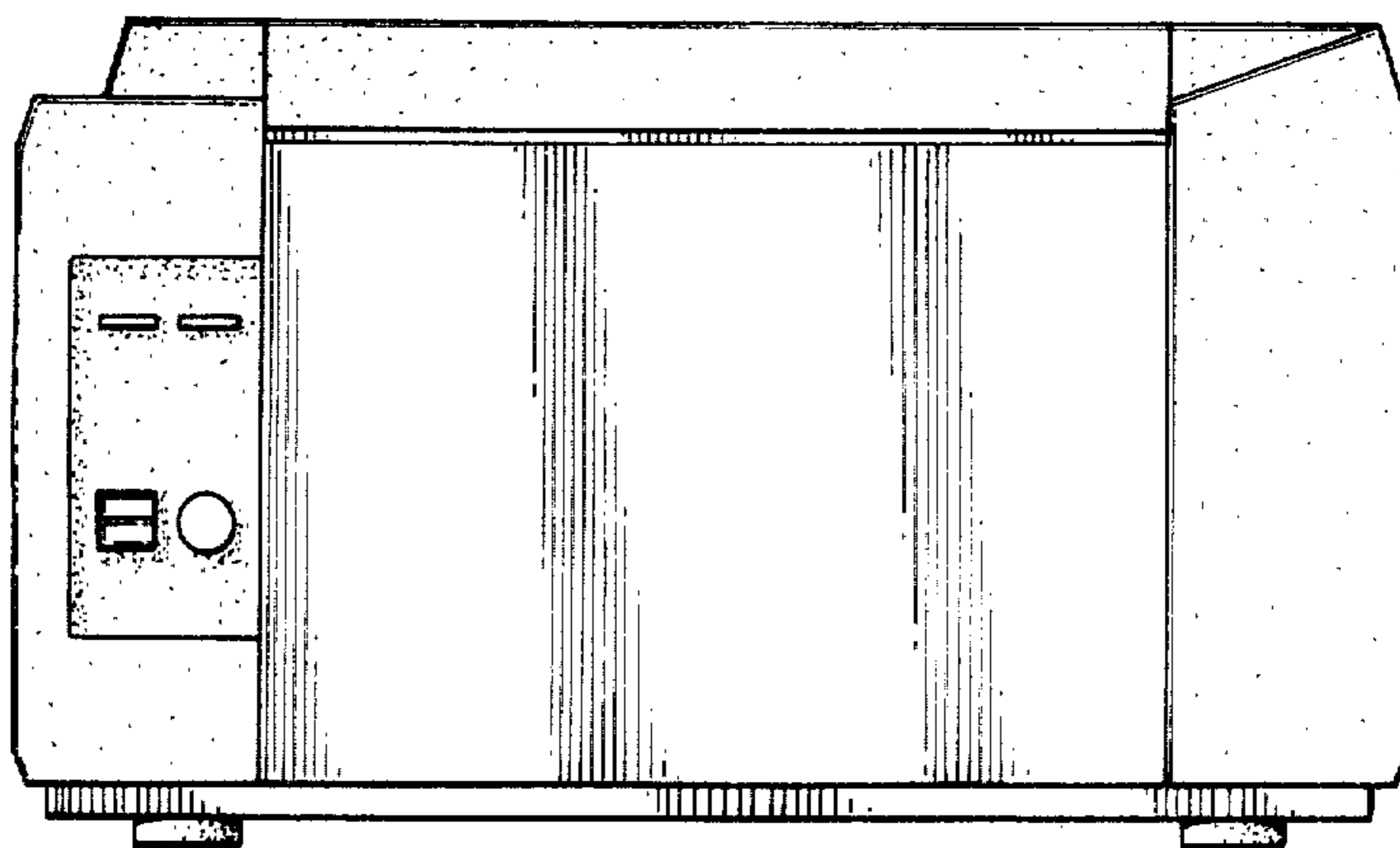

FIG. 5

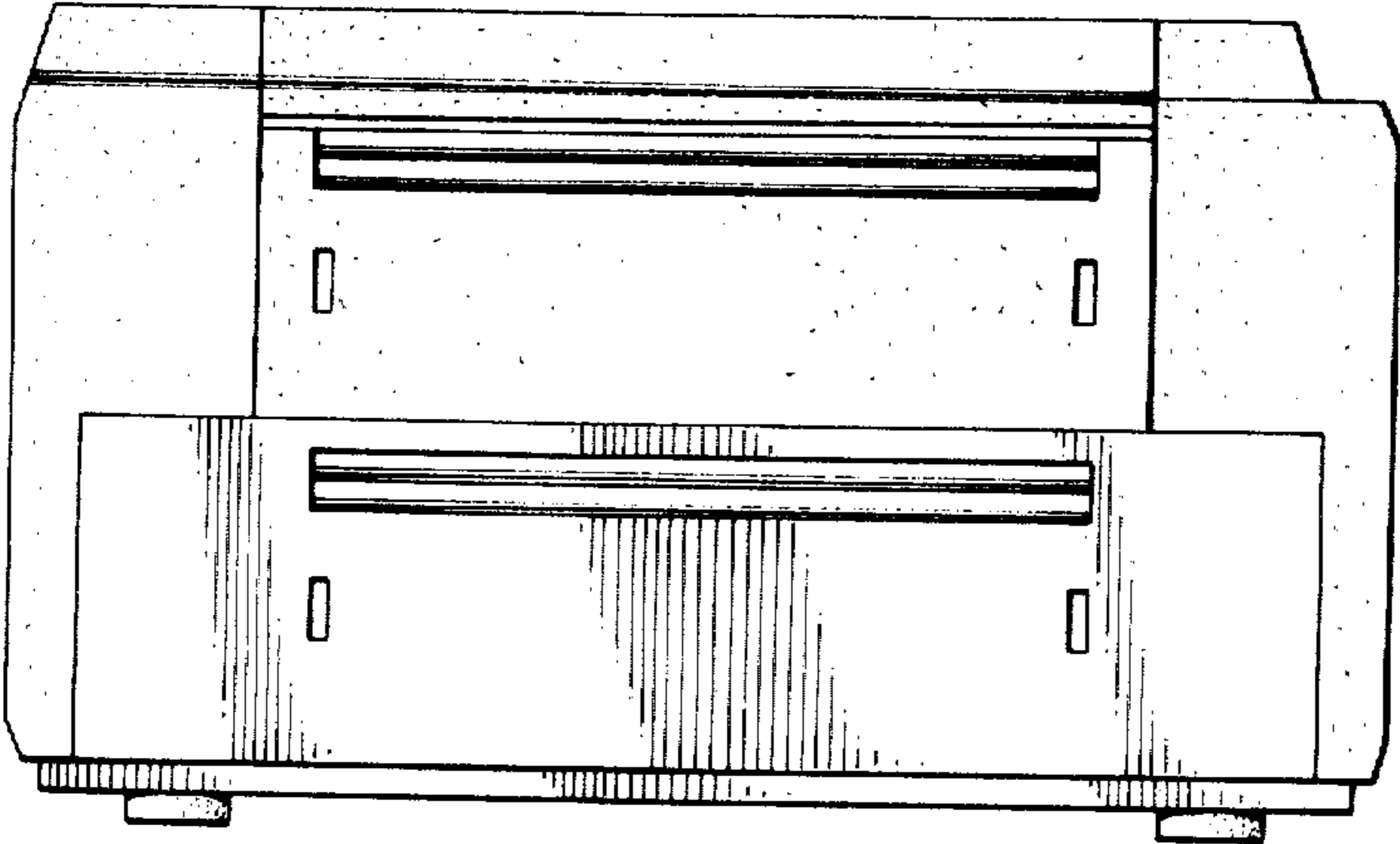

FIG. 6

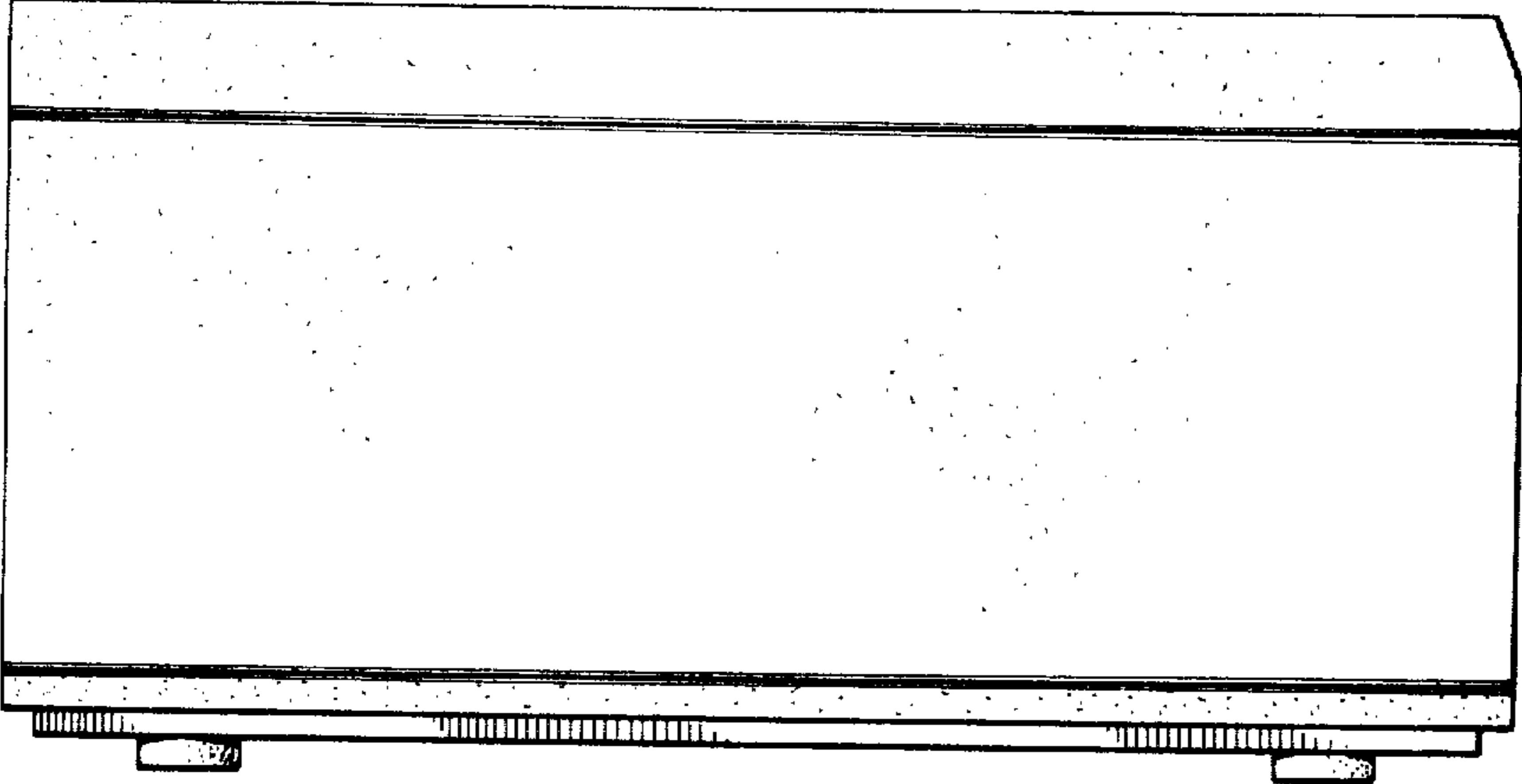

FIG. 7

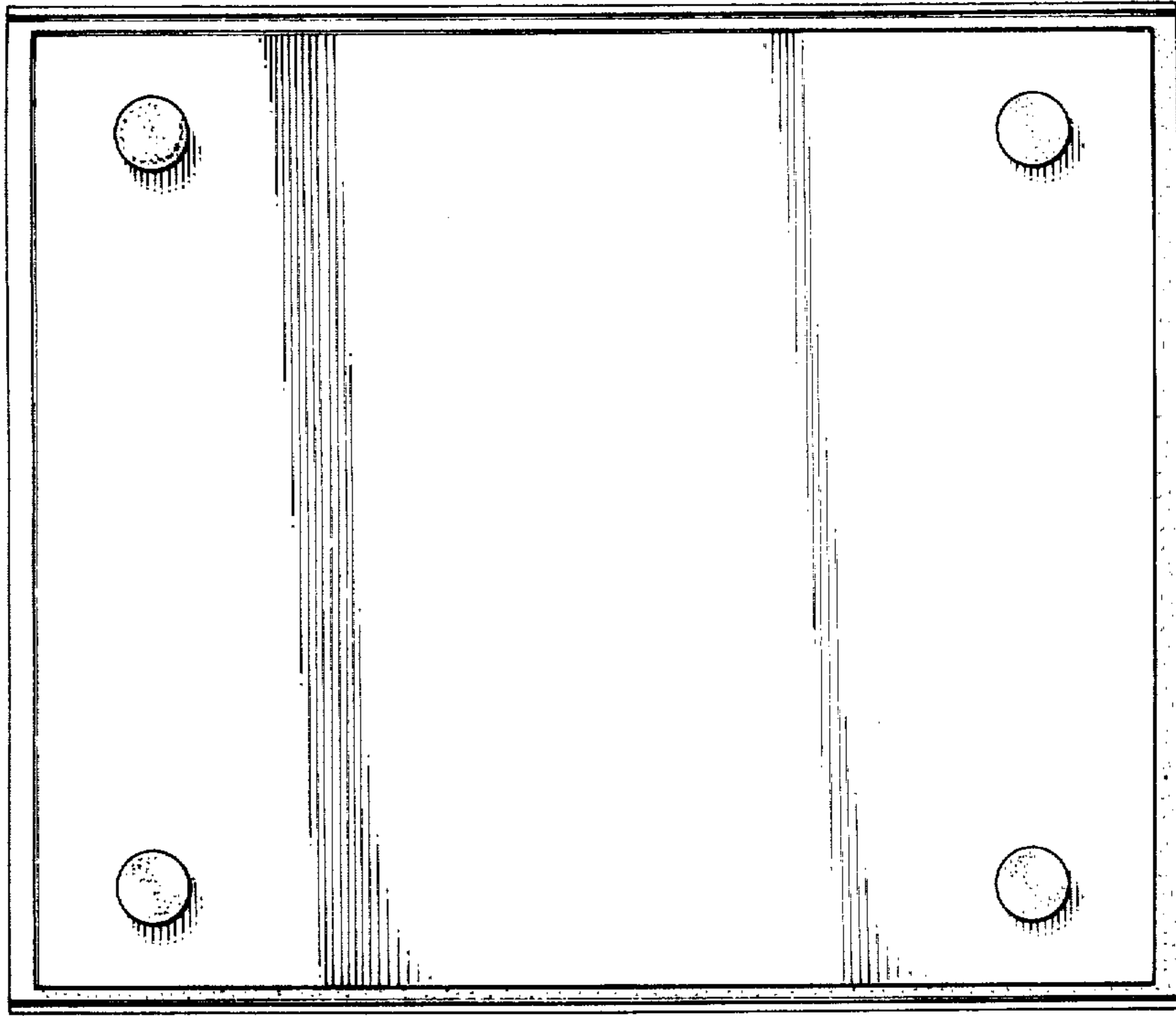

FIG. 8

