

Canty

[54] FISHING FLOAT

[76] Inventor: Dolor P. Canty, Box 1512, Leadville, Colo. 80461

[\*\*] Term: 14 Years

[21] Appl. No.: 69,339

[22] Filed: Aug. 24, 1979

[51] Int. Cl. .... D29-02

[52] U.S. Cl. .... D21/238; D22/30

[58] Field of Search ..... 43/43.1, 43.95; 169/DIG. 1; D21/237, 238; D22/30; 9/310 F, 310 G, 311, 329, 337

[56] References Cited

U.S. PATENT DOCUMENTS

D. 194,571	2/1963	Mercer	.....	D21/237 X
1,838,086	12/1931	Farnstrom	.....	9/337
2,529,961	11/1950	Phillips	.....	9/337
2,720,664	10/1955	Gray	.....	D21/237 X
2,731,759	1/1956	Hornke	.....	43/43.1
2,738,609	3/1956	Reed	.....	43/43.1 X
2,894,270	7/1959	Manthos	.....	9/337 X

3,080,584	3/1963	Brown	.....	9/310 F X
3,135,978	6/1964	Grasmoen	.....	9/310 F X
3,372,412	3/1968	Robertson	.....	9/311
3,657,837	4/1972	Price et al.	.....	43/43.1
3,871,042	3/1975	Farmer	.....	D21/237 X
4,017,927	4/1977	Massey	.....	D21/237 X

Primary Examiner—A. Hugo Word  
Attorney, Agent, or Firm—Max L. Wymore

[57] CLAIM

The ornamental design for a fishing float, as shown and described.

DESCRIPTION

FIG. 1 is a top perspective view of the fishing float showing my new design;  
FIG. 2 is a top perspective view as in FIG. 1 with a protective cover positioned over a portion thereof;  
FIG. 3 is a top plan view thereof;  
FIG. 4 is a bottom plan view thereof;  
FIG. 5 is a side view thereof with the opposite side being a mirror image;  
FIG. 6 is a front view in elevation; and,  
FIG. 7 is a rear view in elevation thereof.

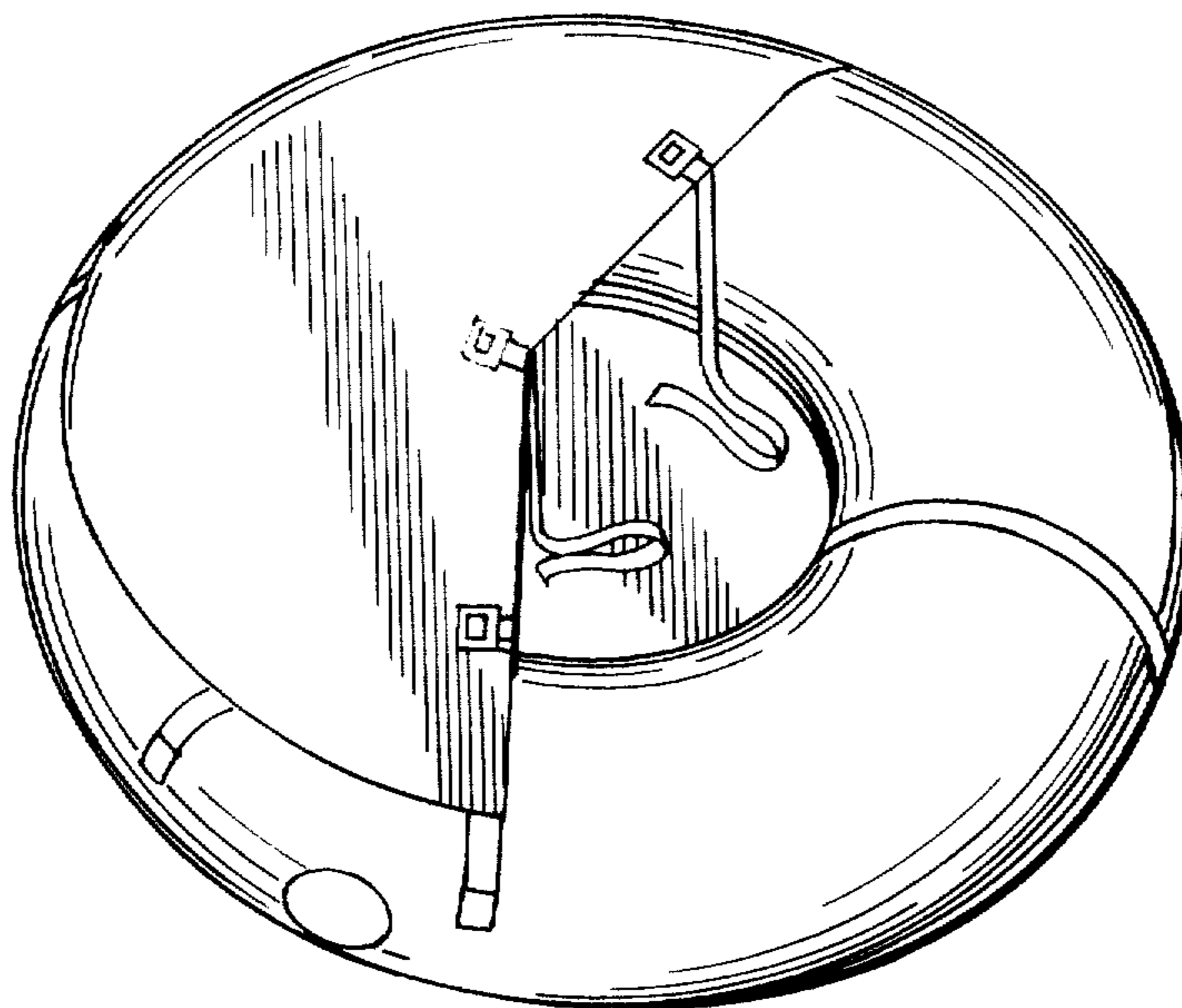

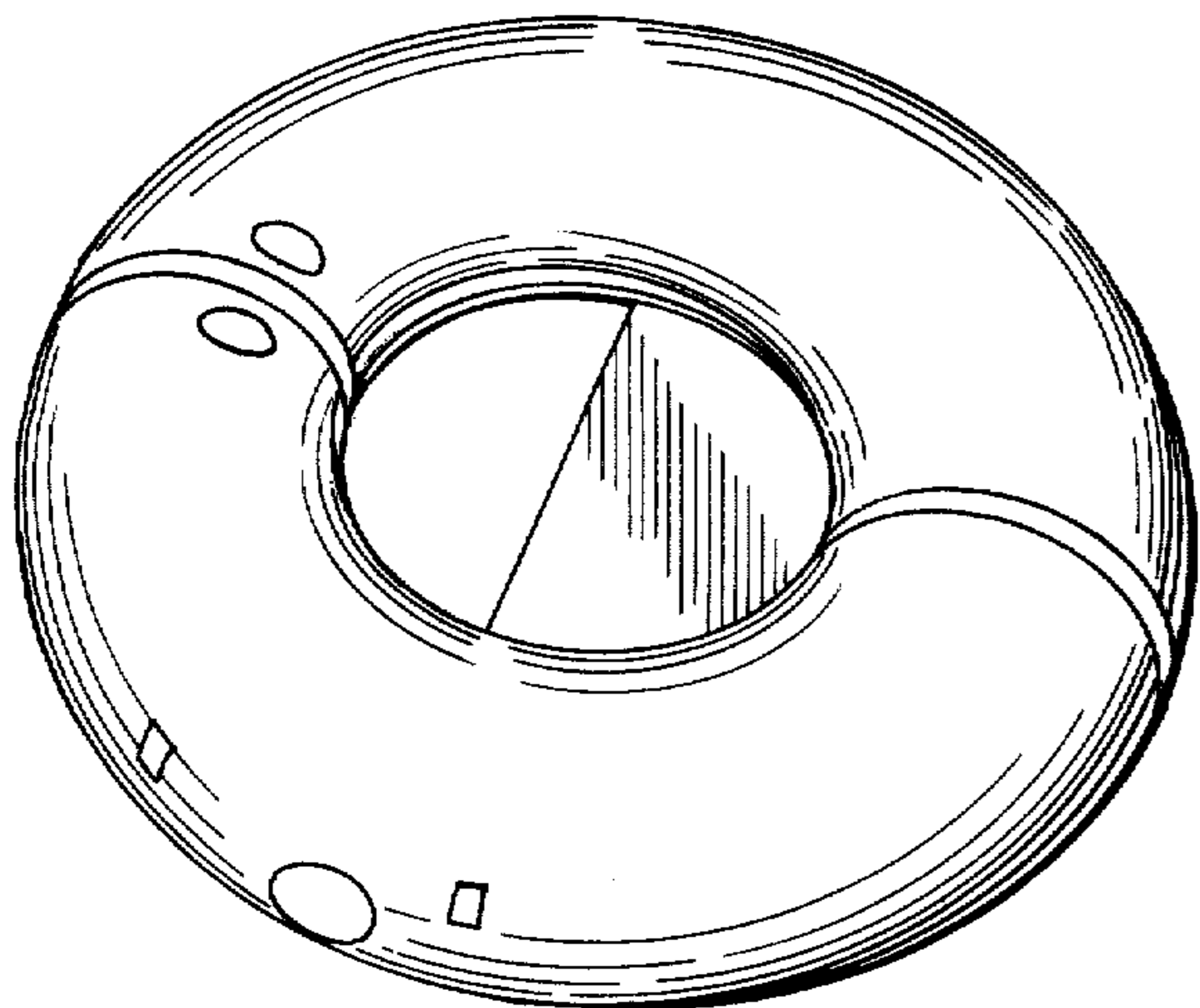

FIG. 1

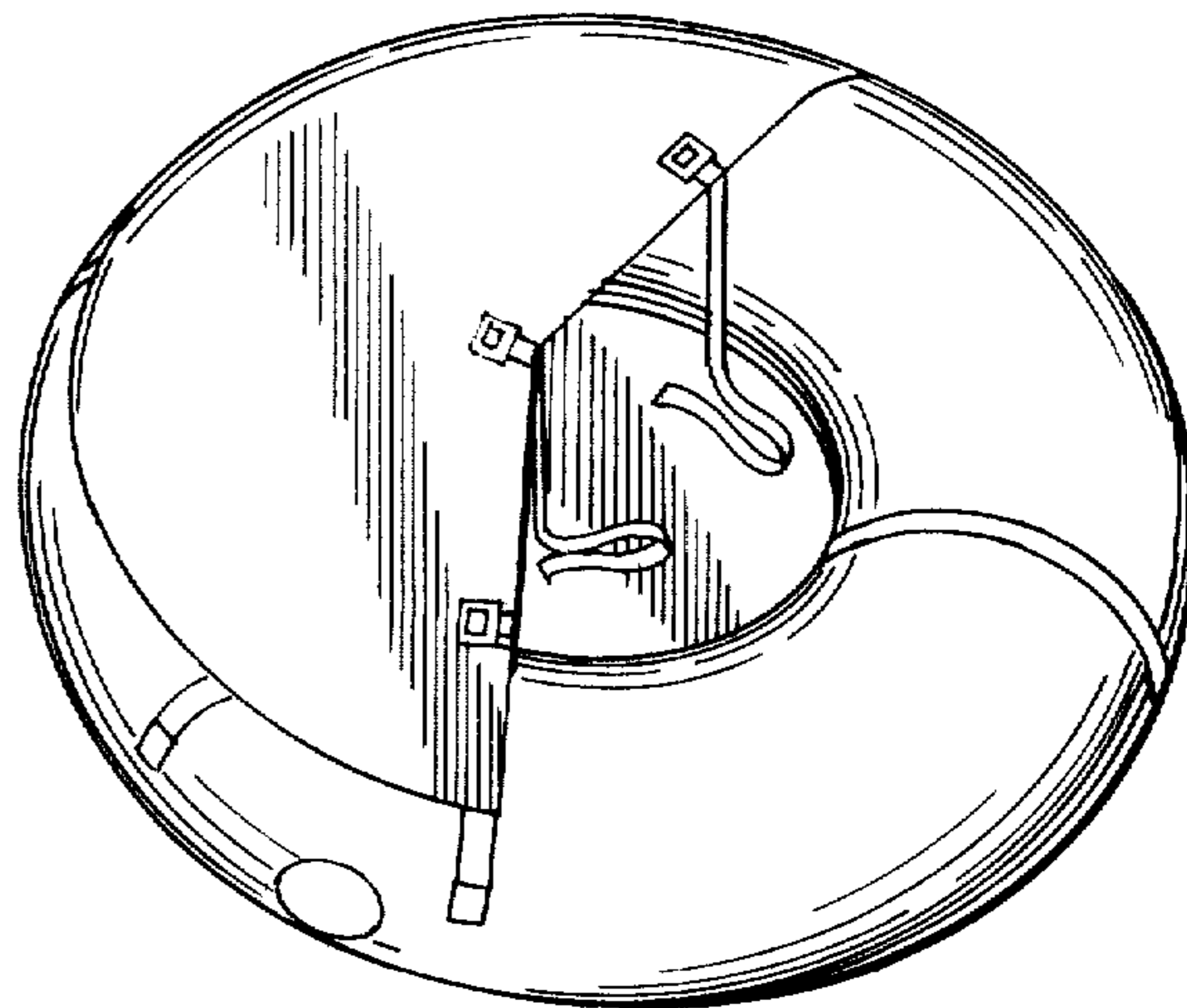

FIG. 2

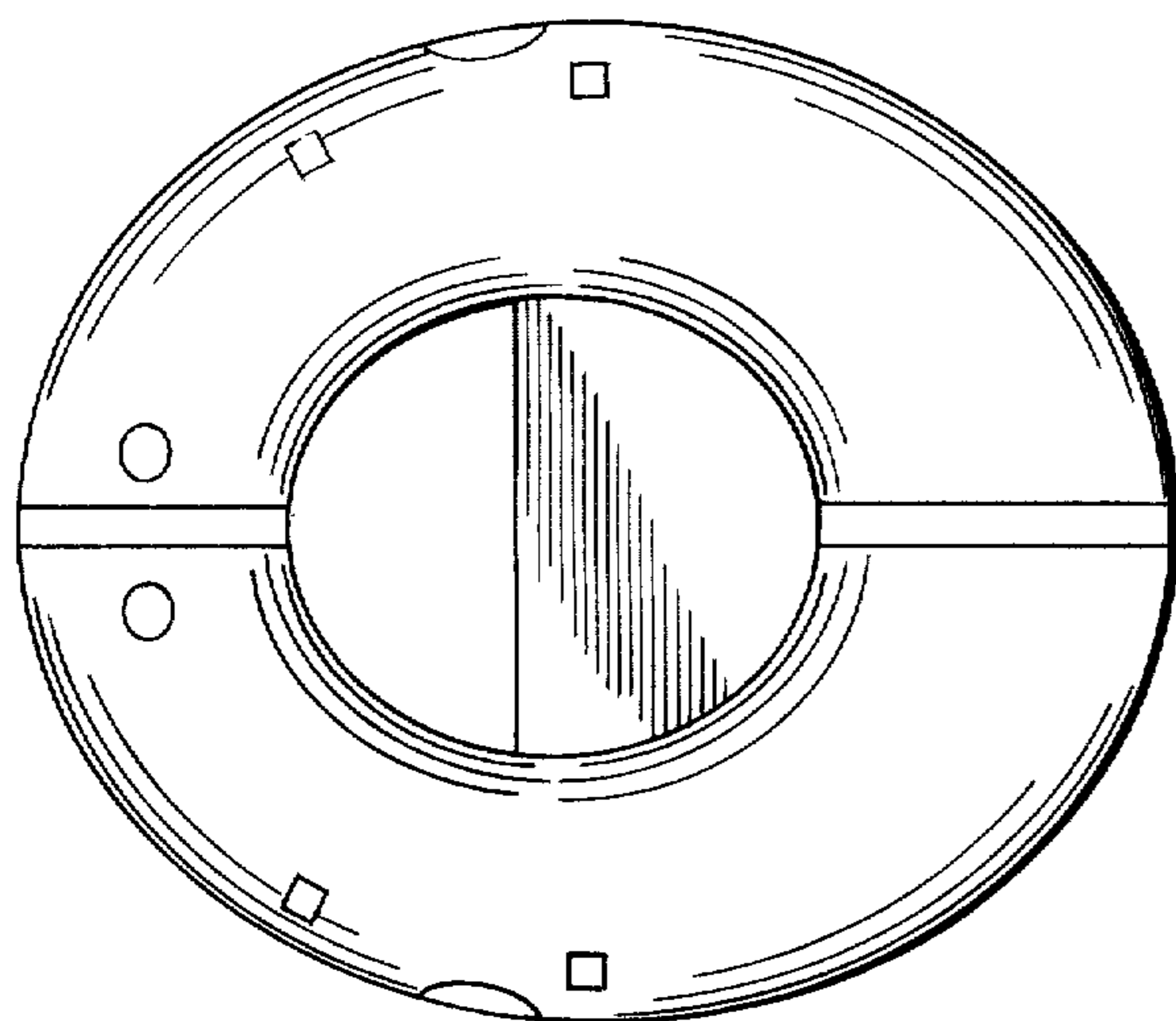

FIG. 3

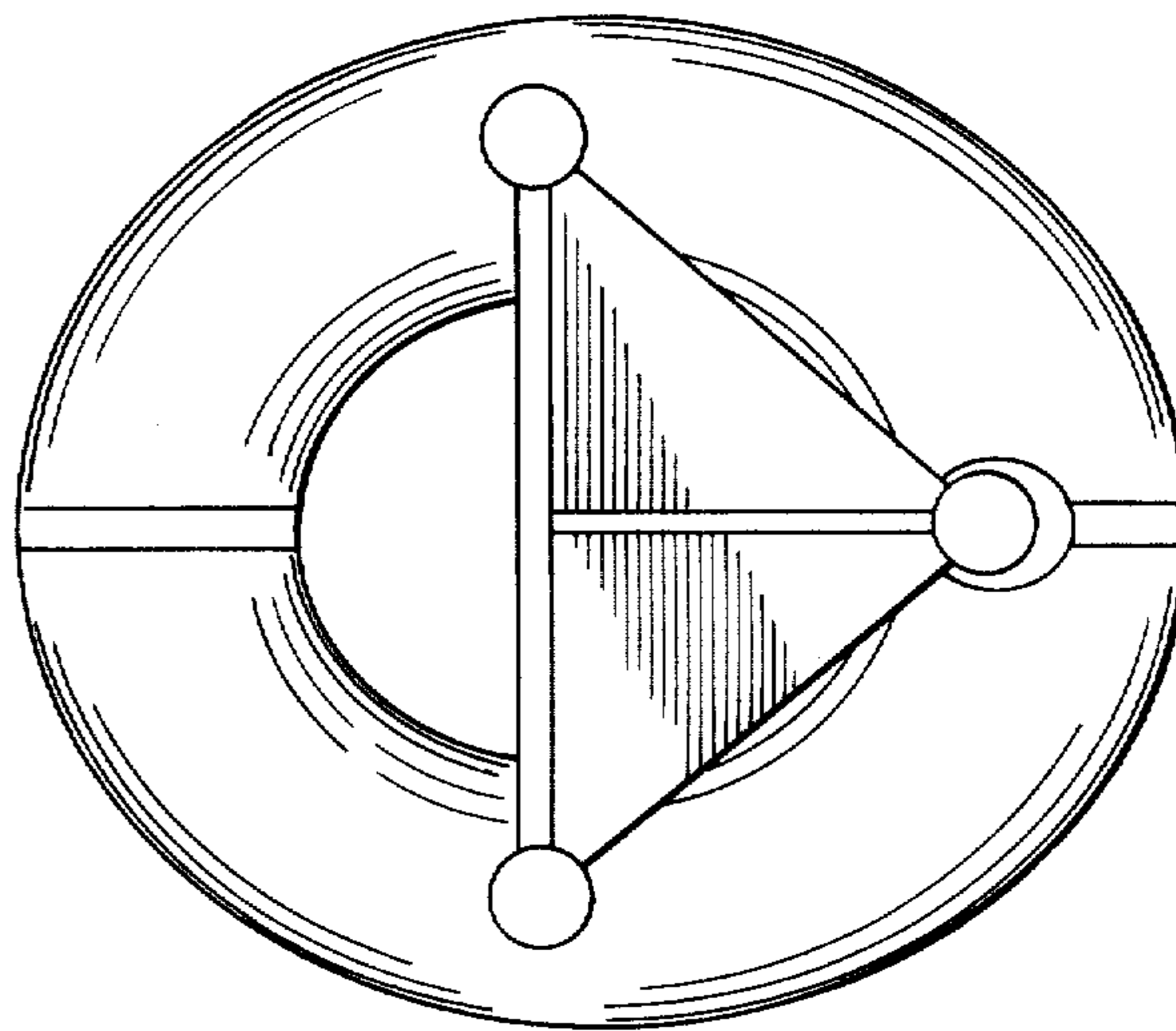

FIG. 4

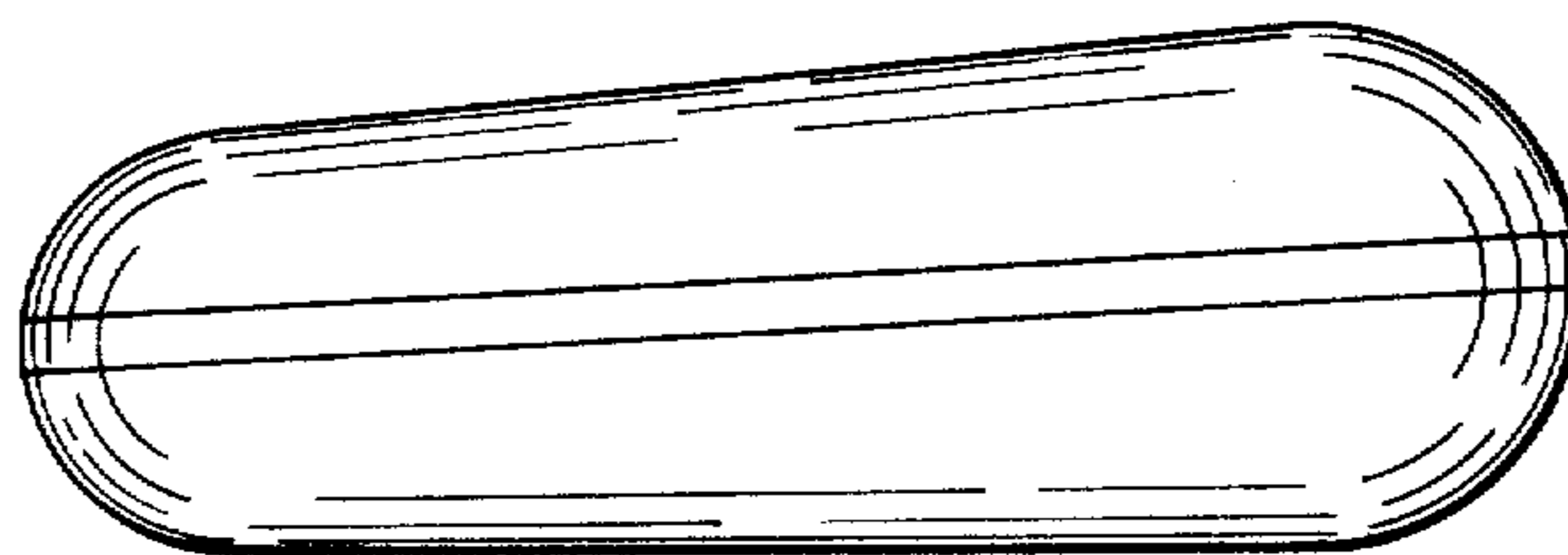

FIG. 5

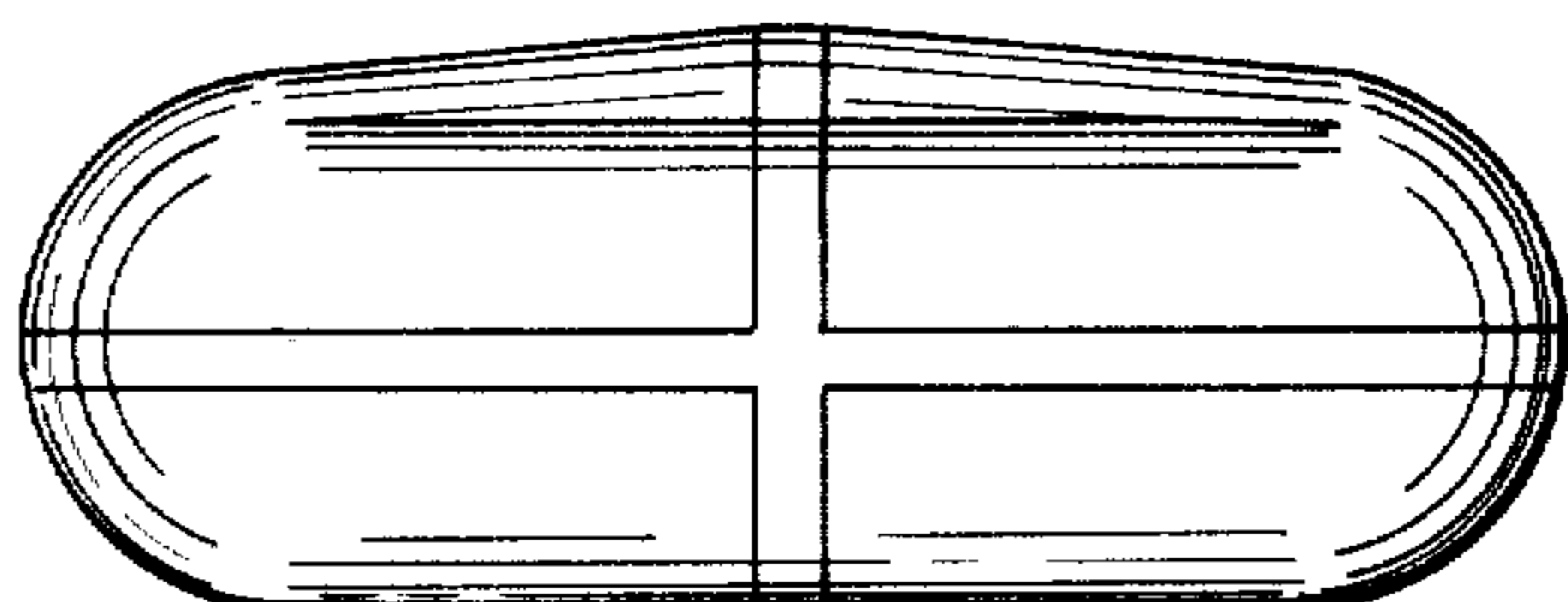

FIG. 6

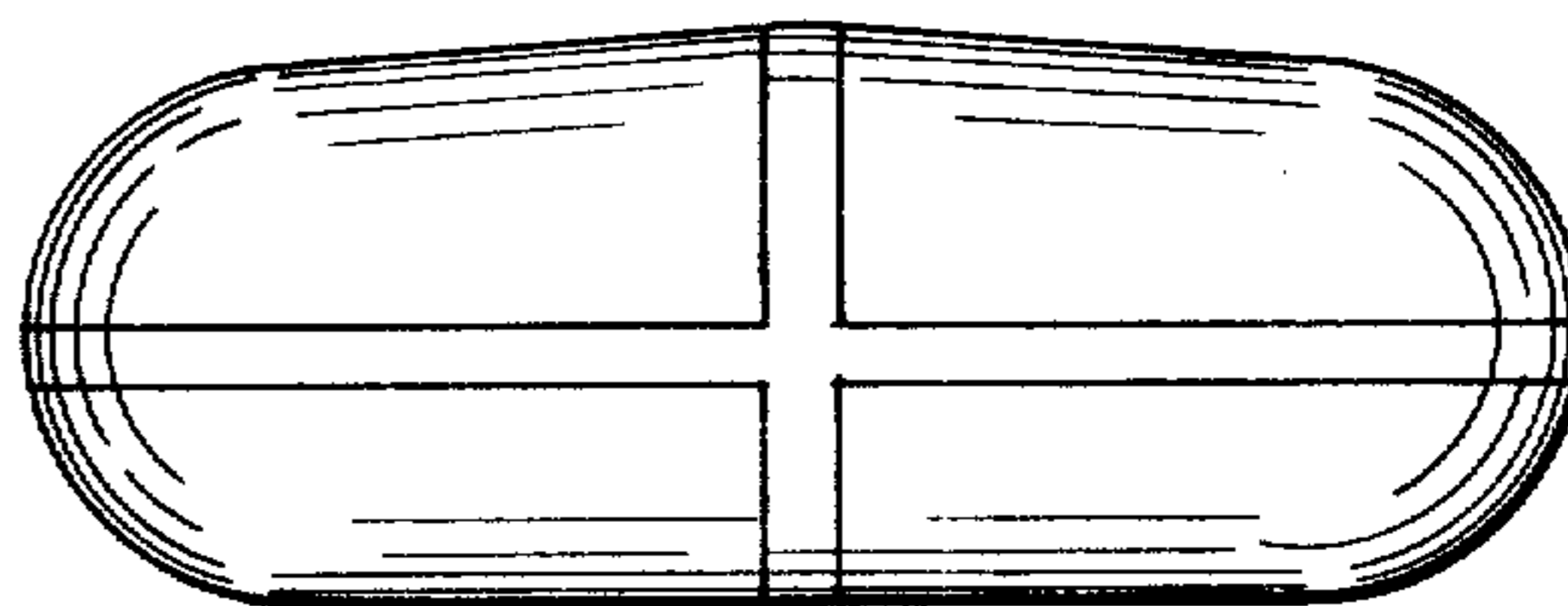

FIG. 7