

[54] WALL ANCHOR

2,404,928 7/1946 Schutlen 411/427
3,205,759 9/1965 Texler 411/44

[75] Inventor: Ruediger Einhorn, Katonah, N.Y.

Primary Examiner—B. J. Bullock

[73] Assignee: Coats & Clark, Inc., Stamford, Conn.

Attorney, Agent, or Firm—Burgess, Ryan and Wayne

[**] Term: 14 Years

[57] CLAIM

[21] Appl. No.: 74,754

The ornamental design for a wall anchor, substantially as shown and described.

[22] Filed: Sep. 12, 1979

DESCRIPTION

[51] Int. Cl. D8-08

FIG. 1 is a top plan view of a wall anchor according to my design;

[52] U.S. Cl. D8/385

FIG. 2 is a front elevational view, the rear being identical;

[58] Field of Search D8/382, 385, 386;
411/44, 57, 59, 63-65, 71, 37, 427

FIG. 3 is a side elevational view thereof;

[56] References Cited

U.S. PATENT DOCUMENTS

D. 106,861 11/1937 Dellinger D8/385
2,150,080 3/1939 Rawlings 411/37

FIG. 4 is a bottom plan view thereof;

FIG. 5 is a sectional view taken in the direction of the arrows on line 5-5 of FIG. 3; and

FIG. 6 is a sectional view taken on line 6-6 of FIG. 3.

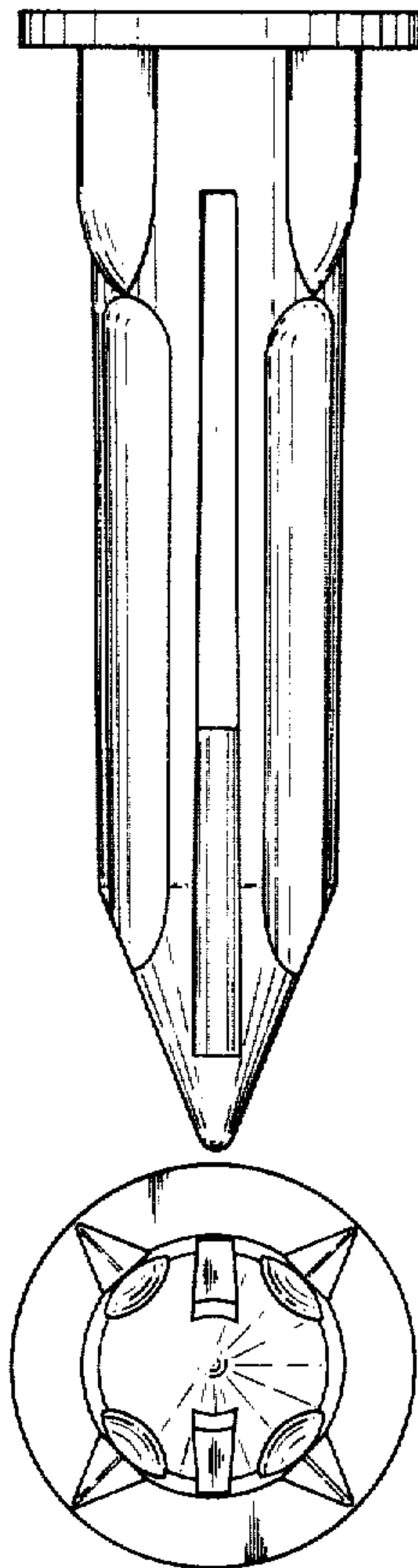

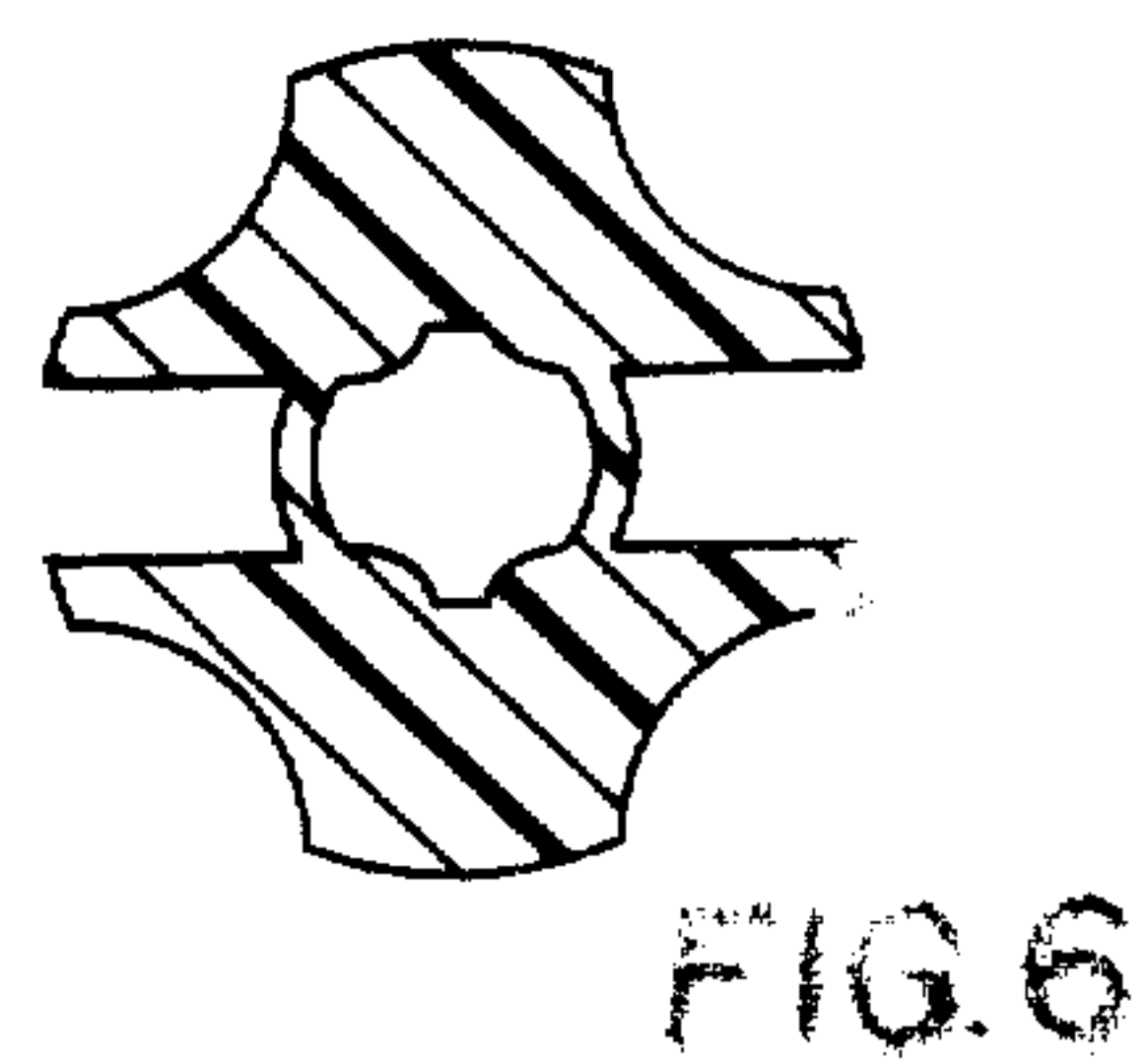
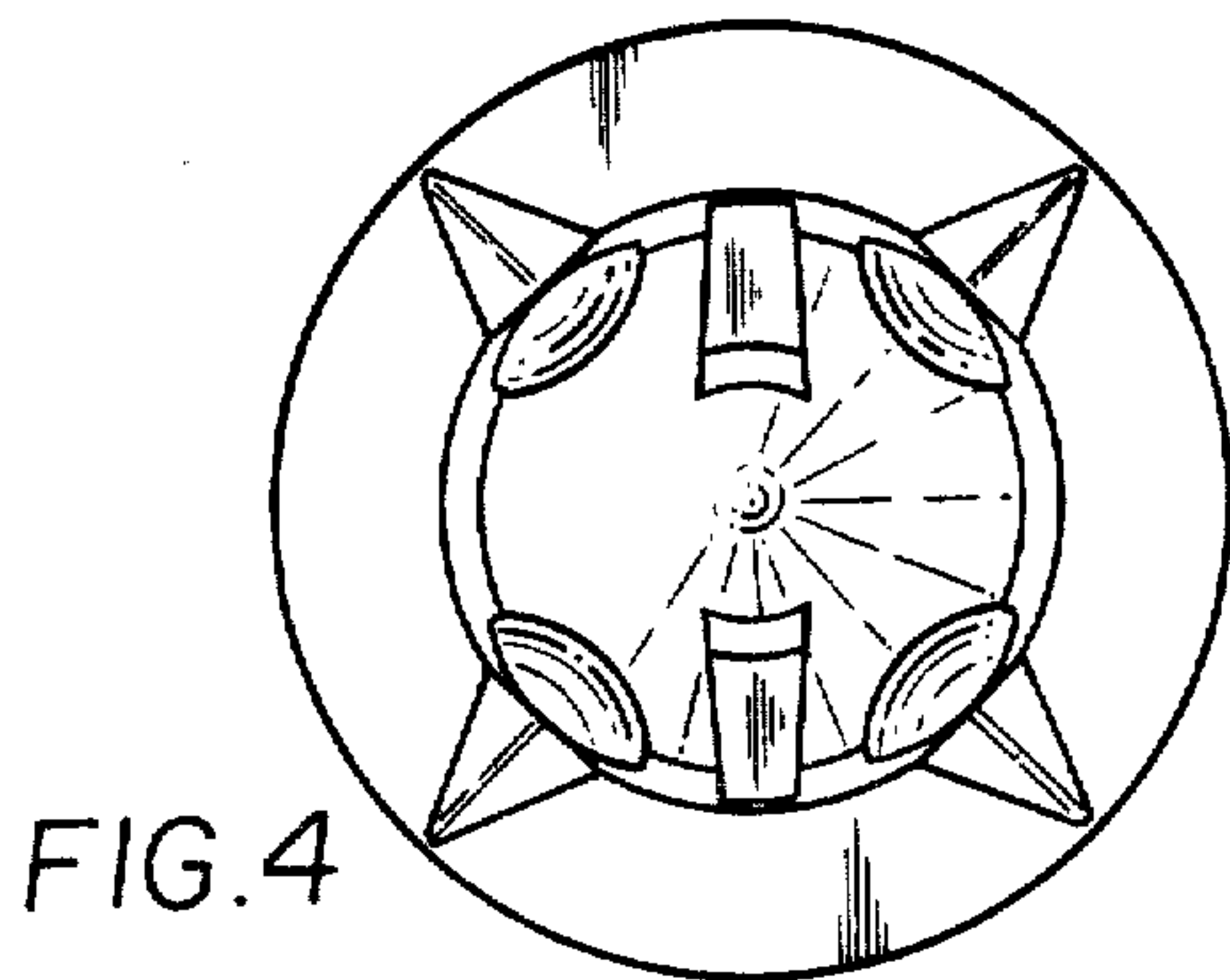
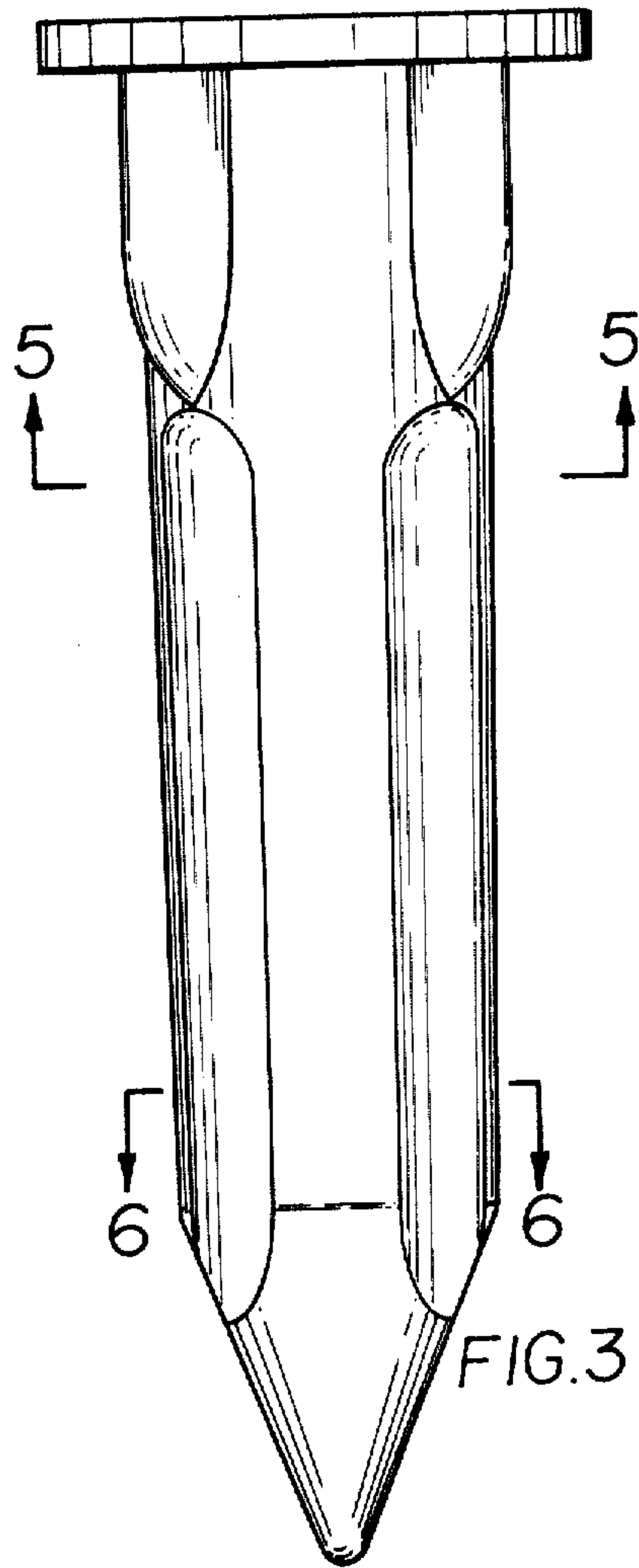
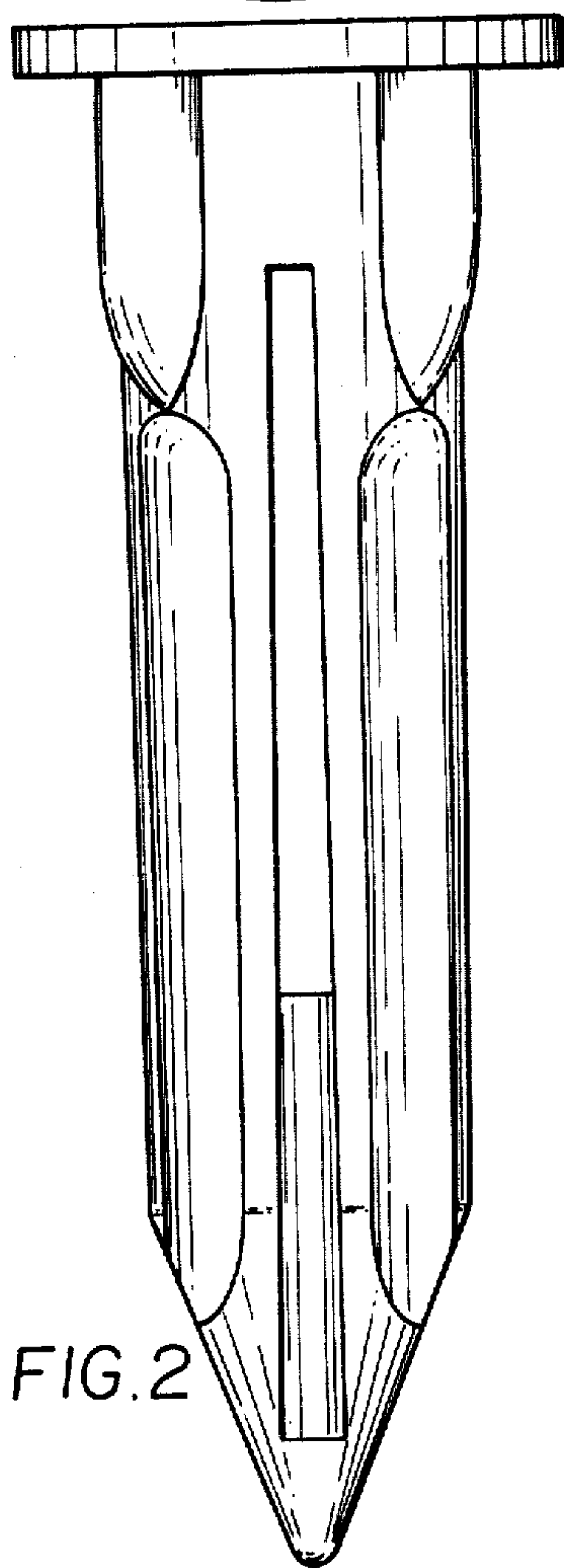
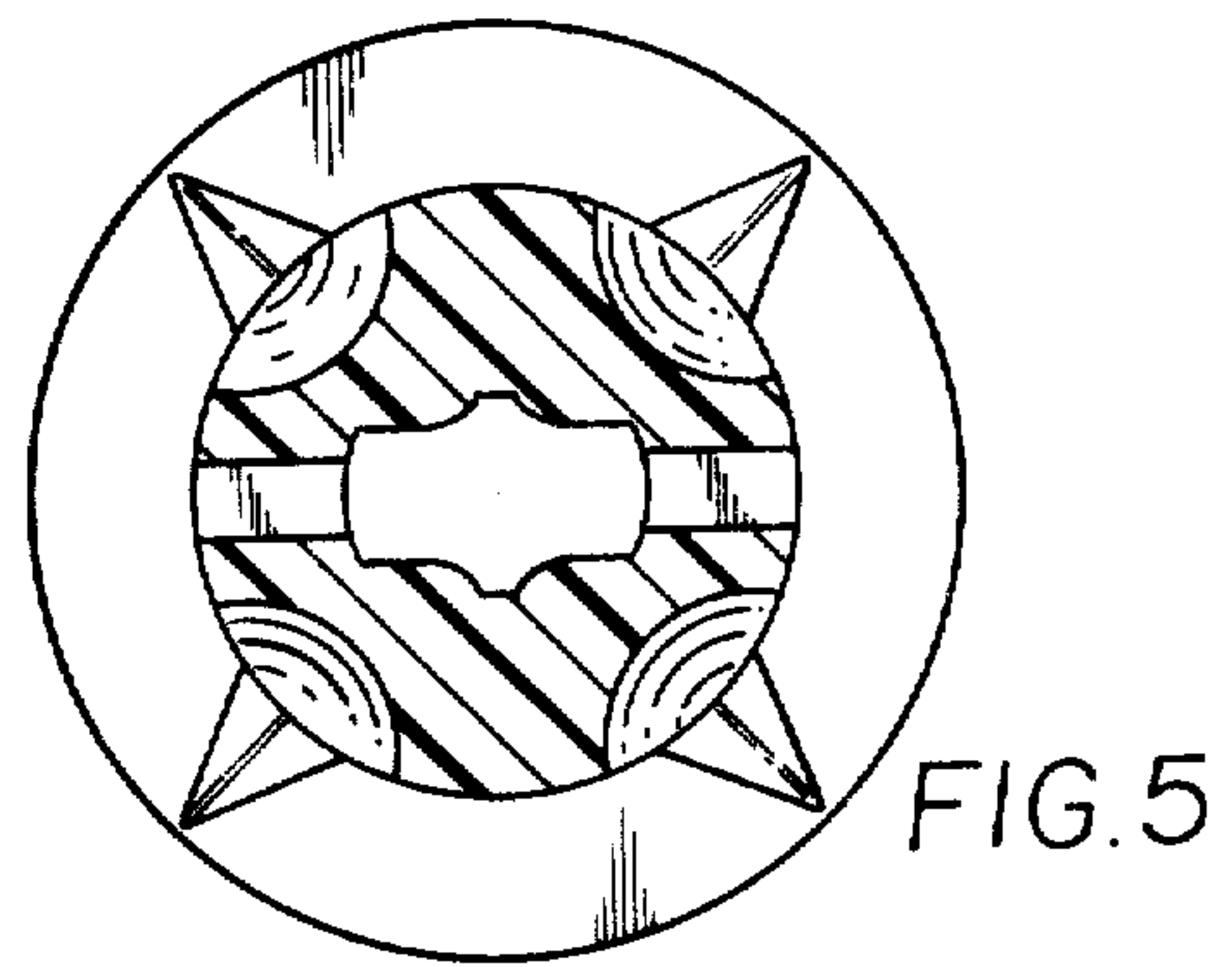
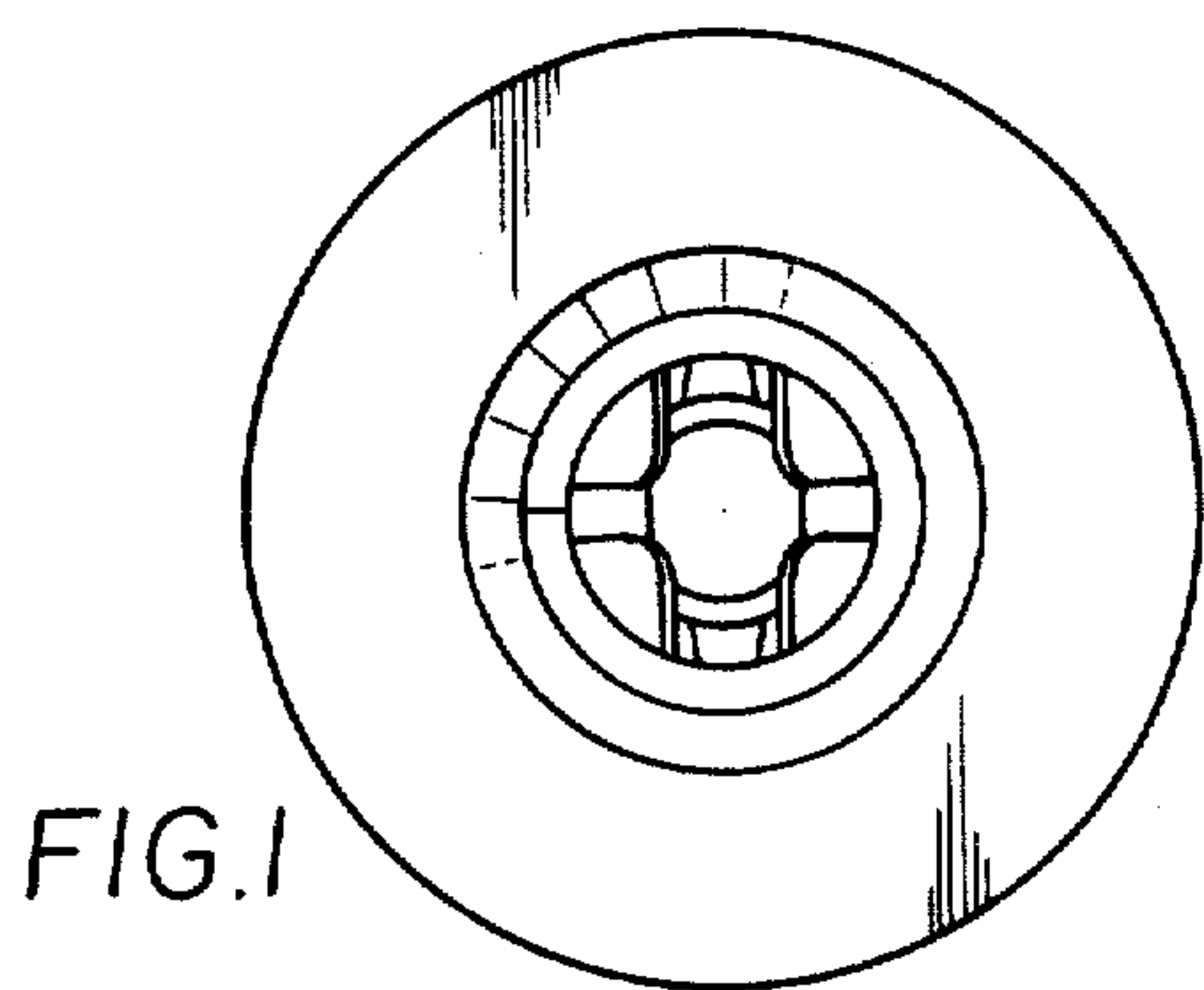

5

5

6

6