

[54] SIMULATIVE PLAYHOUSE OR SIMILAR ARTICLE

[76] Inventors: Michael R. LaCrone, 532 Via Pacheco, San Lorenzo, Calif. 94580; Richard Hamilton, 503 Harris Rd., Hayward, Calif. 94547

[**] Term: 14 Years

[21] Appl. No.: 39,696

[22] Filed: May 16, 1979

[51] Int. Cl. D21-01
[52] U.S. Cl. D21/115; D21/87
[58] Field of Search D21/114, 115, 119, 87, D21/82, 88; D9/29, 197, 205; D25/7, 10; 46/146, 12, 11, 1 H; D12/72

[56]

References Cited
U.S. PATENT DOCUMENTS

D. 198,038	4/1964	Huston	D21/87
D. 219,042	10/1970	King et al.	D21/87
D. 235,365	6/1975	Gay et al.	D21/114
D. 240,437	7/1976	Rizzo	D21/87
3,808,732	5/1974	Gay et al.	46/12

Primary Examiner—Charles A. Rademaker
Attorney, Agent, or Firm—Bielen and Peterson

[57]

CLAIM

The ornamental design for a simulative playhouse or similar article, substantially as shown.

DESCRIPTION

FIG. 1 is a top perspective view of a simulative playhouse or similar article showing our new design;
FIG. 2 is a top plan view;
FIG. 3 is a front elevational view;
FIG. 4 is a rear elevational view;
FIG. 5 is a right side elevational view;
FIG. 6 is a left side elevational view;
FIG. 7 is a bottom plan view.

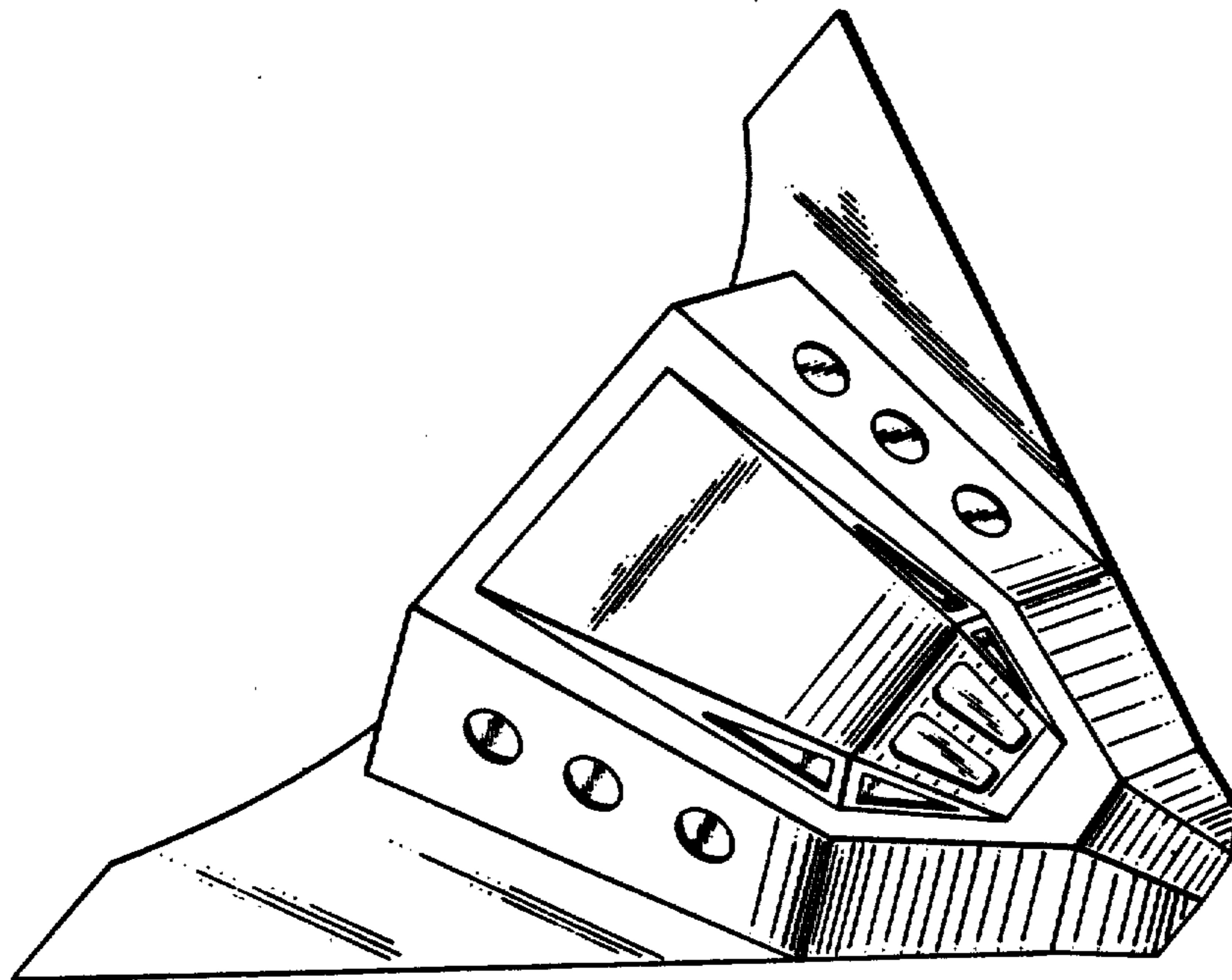

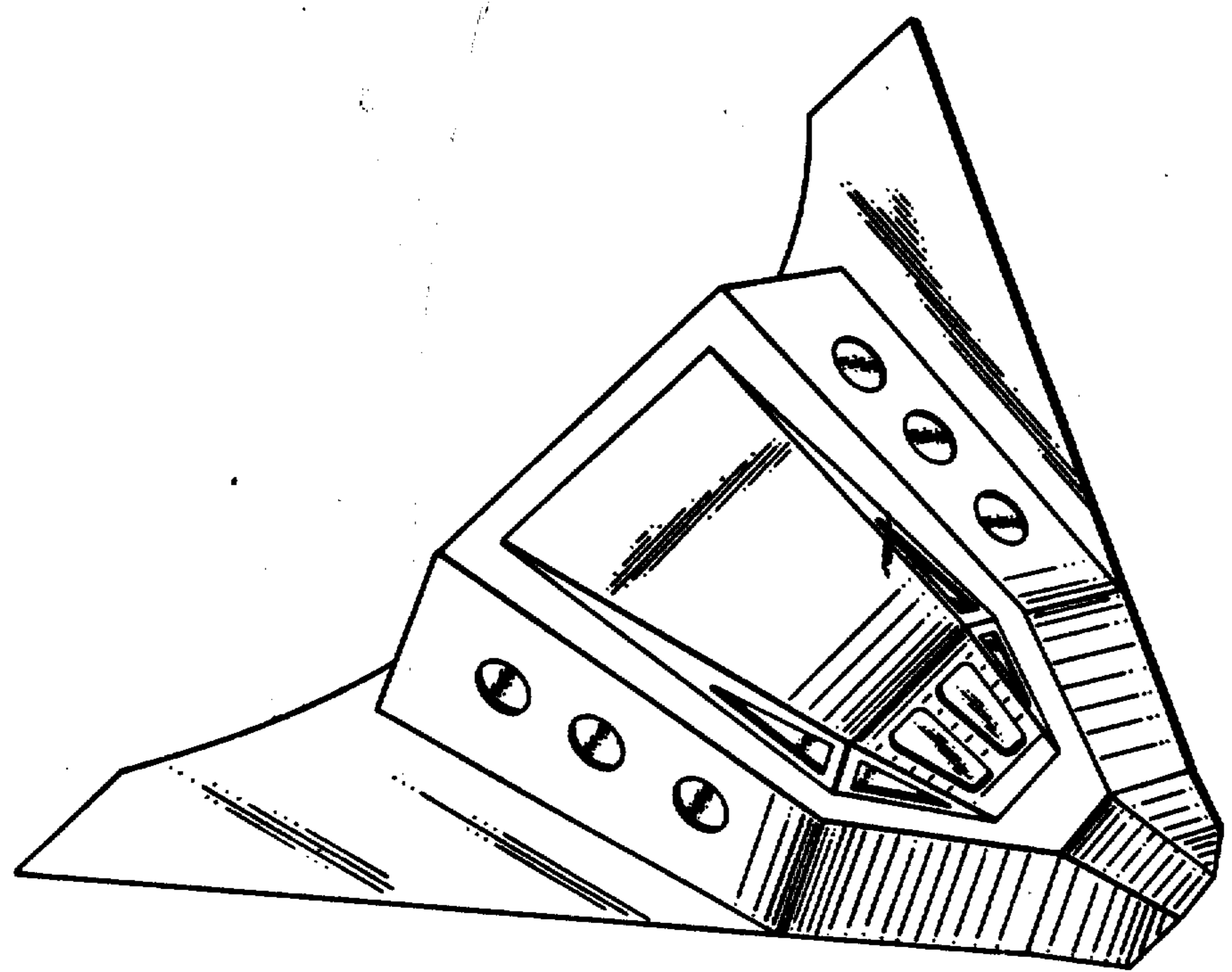

FIG. 1

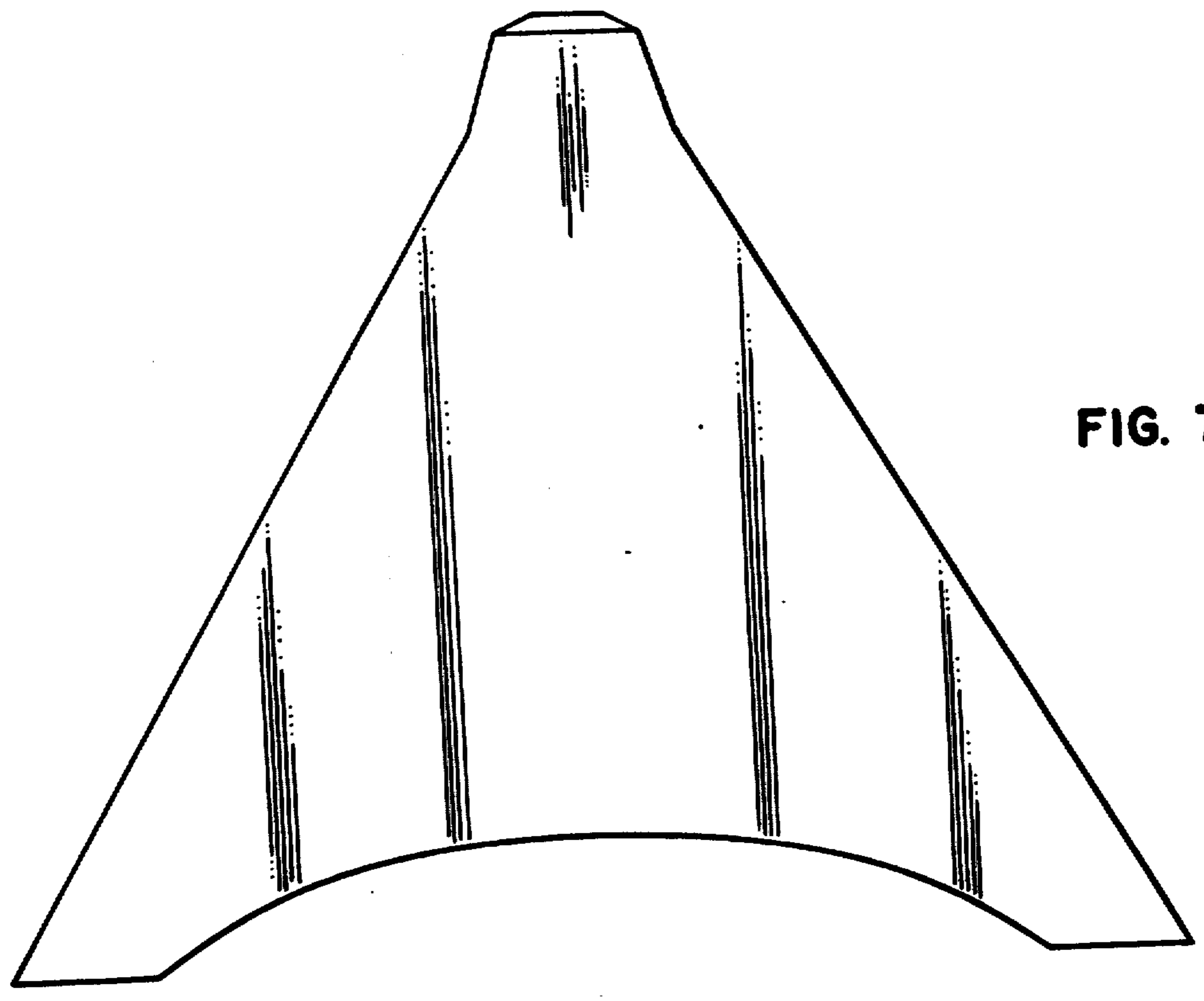

FIG. 7

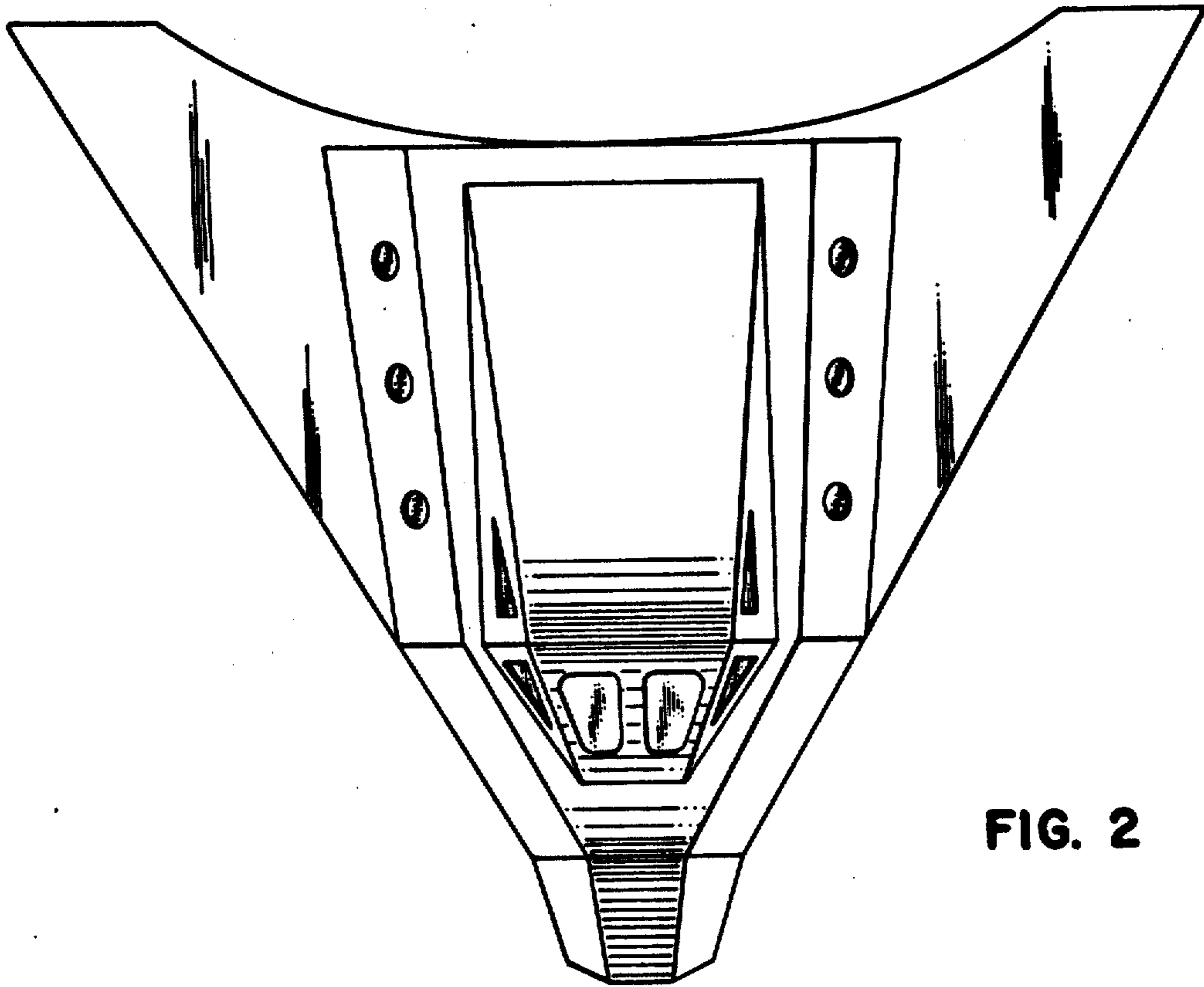

FIG. 2

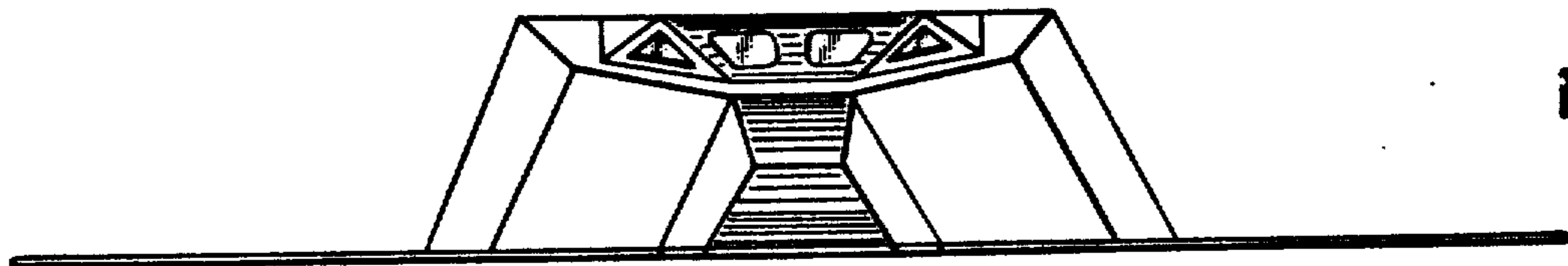

FIG. 3

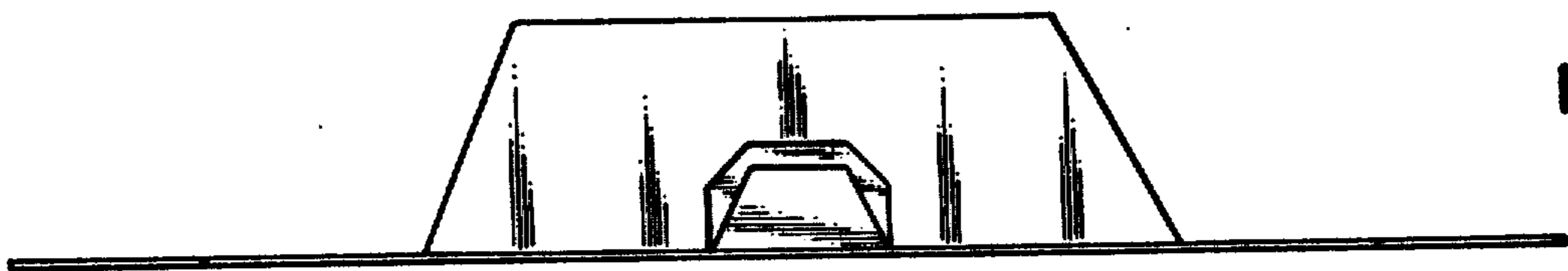

FIG. 4

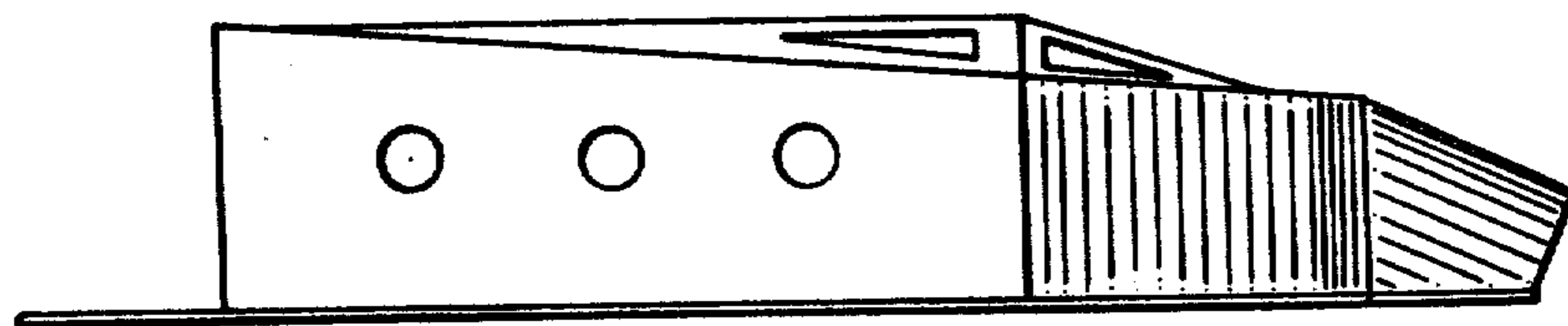

FIG. 5

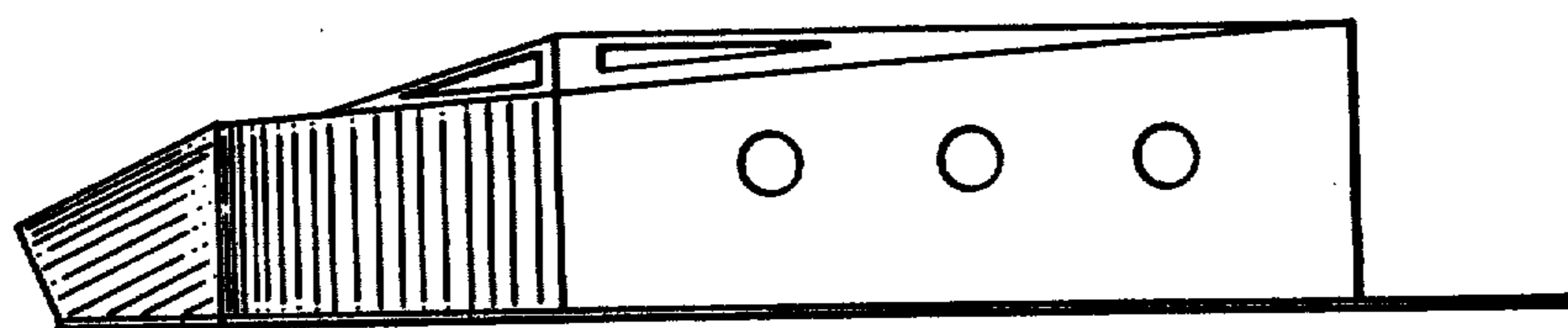

FIG. 6