

[54] **FACSIMILE MACHINE**
[75] **Inventor: Manzo Yoshihama, Yokohama, Japan**
[73] **Assignee: Ricoh Company, Ltd., Japan**
[**] **Term: 7 Years**
[21] **Appl. No.: 41,251**
[22] **Filed: May 21, 1979**
[30] **Foreign Application Priority Data**
Nov. 21, 1978 [JP] Japan 53-49417
[51] **Int. Cl. D16-03**
[52] **U.S. Cl. D16/30**
[58] **Field of Search D14/94; D16/27-32;**
353/3 R, 3 DD, 3 P, 8, 9, 64, 65, 66

[56] **References Cited**
U.S. PATENT DOCUMENTS
3,891,315 6/1975 Kolibas 355/66
Primary Examiner—Peter M. Caun
Attorney, Agent, or Firm—McGlew & Tuttle

[57] **CLAIM**
An ornamental design for a facsimile machine, substantially as described and shown.

DESCRIPTION
FIG. 1 is a front, top and left side perspective view of a facsimile machine showing my new design;
FIG. 2 is a front elevational view thereof;
FIG. 3 is a right side elevational view thereof;
FIG. 4 is a left side elevational view thereof;
FIG. 5 is a rear elevational view thereof;
FIG. 6 is a top plan view thereof; and
FIG. 7 is a bottom plan view thereof.

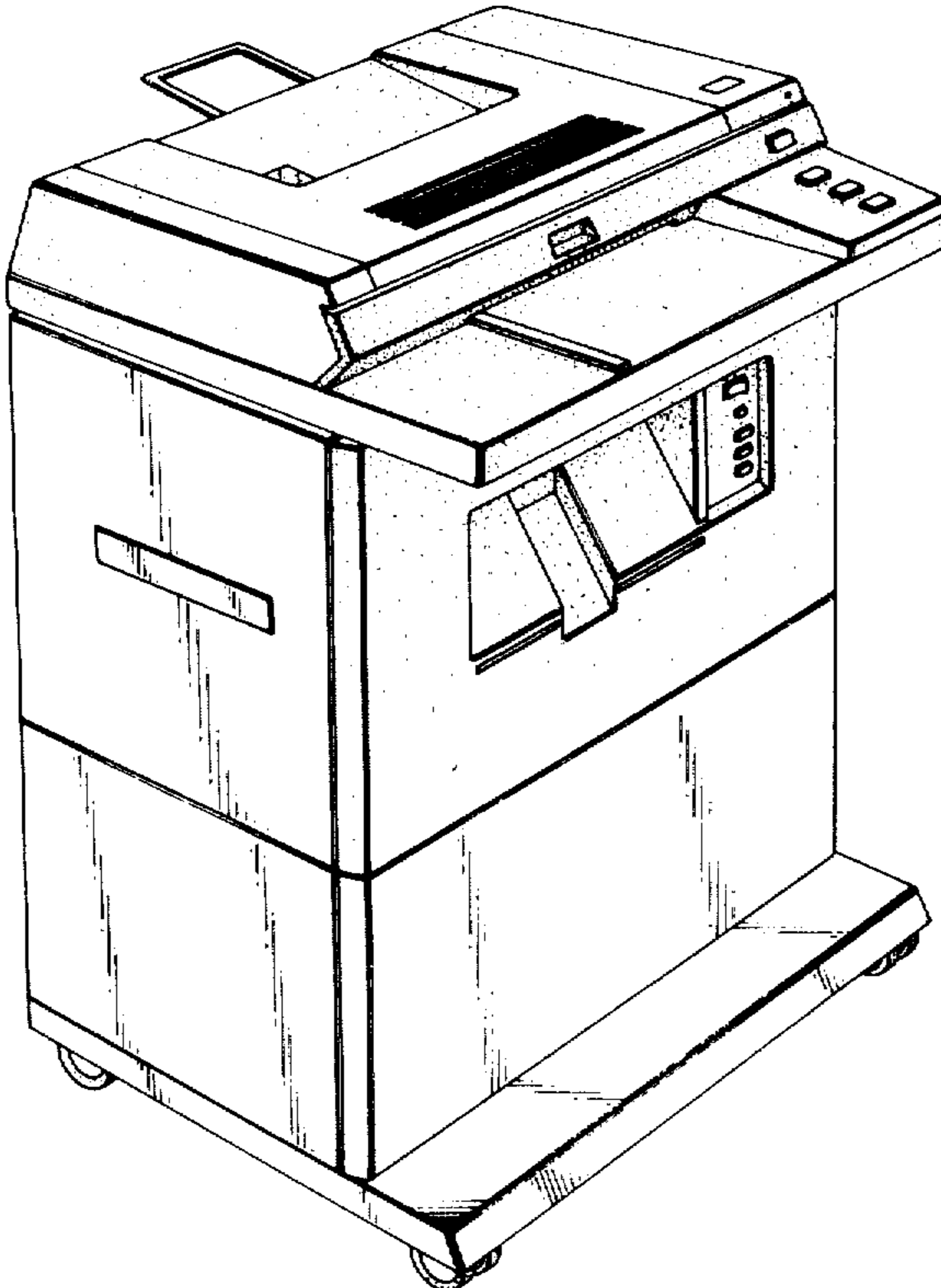

FIG. 1

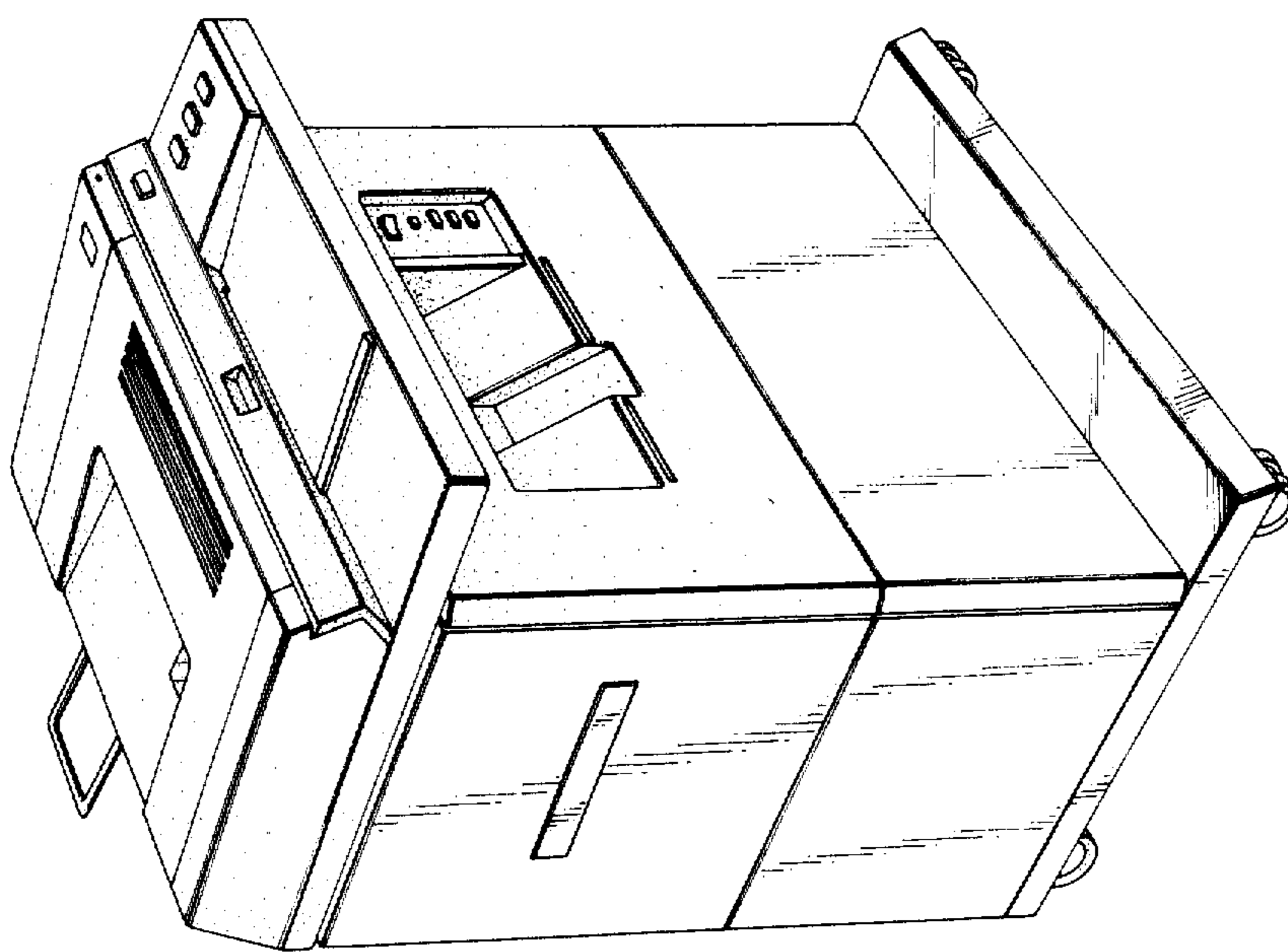

FIG. 3

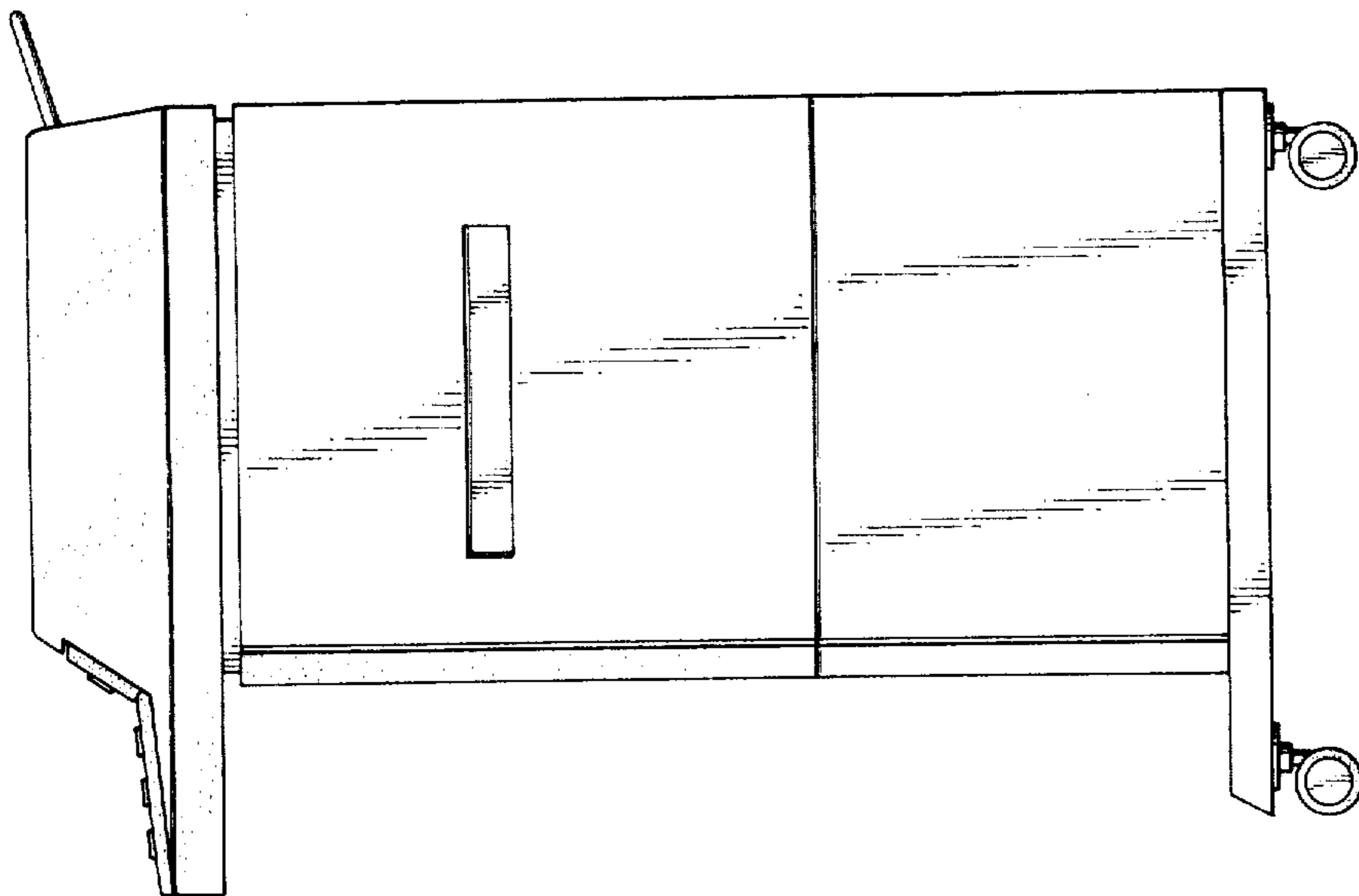

FIG. 2

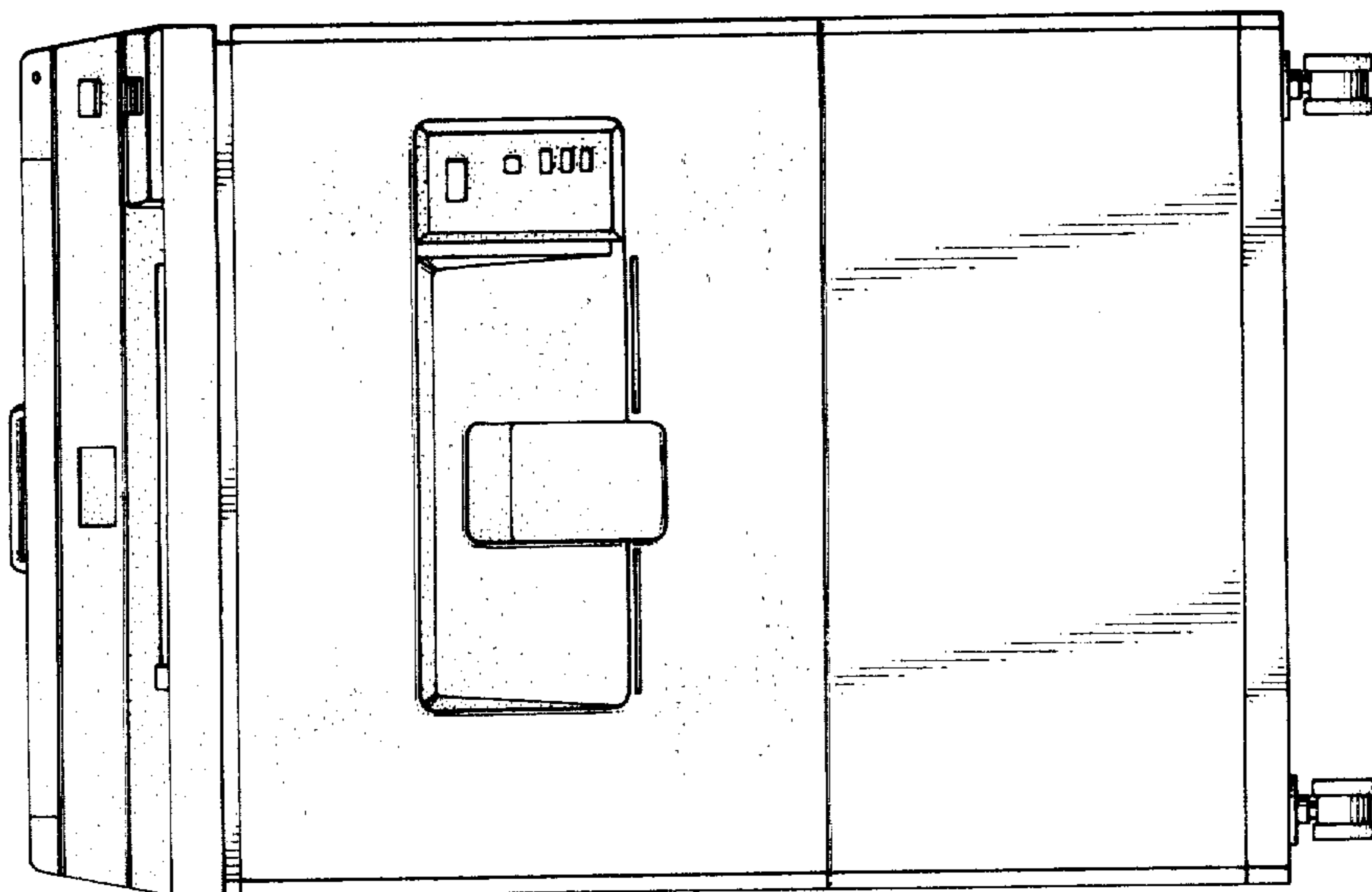

FIG. 5

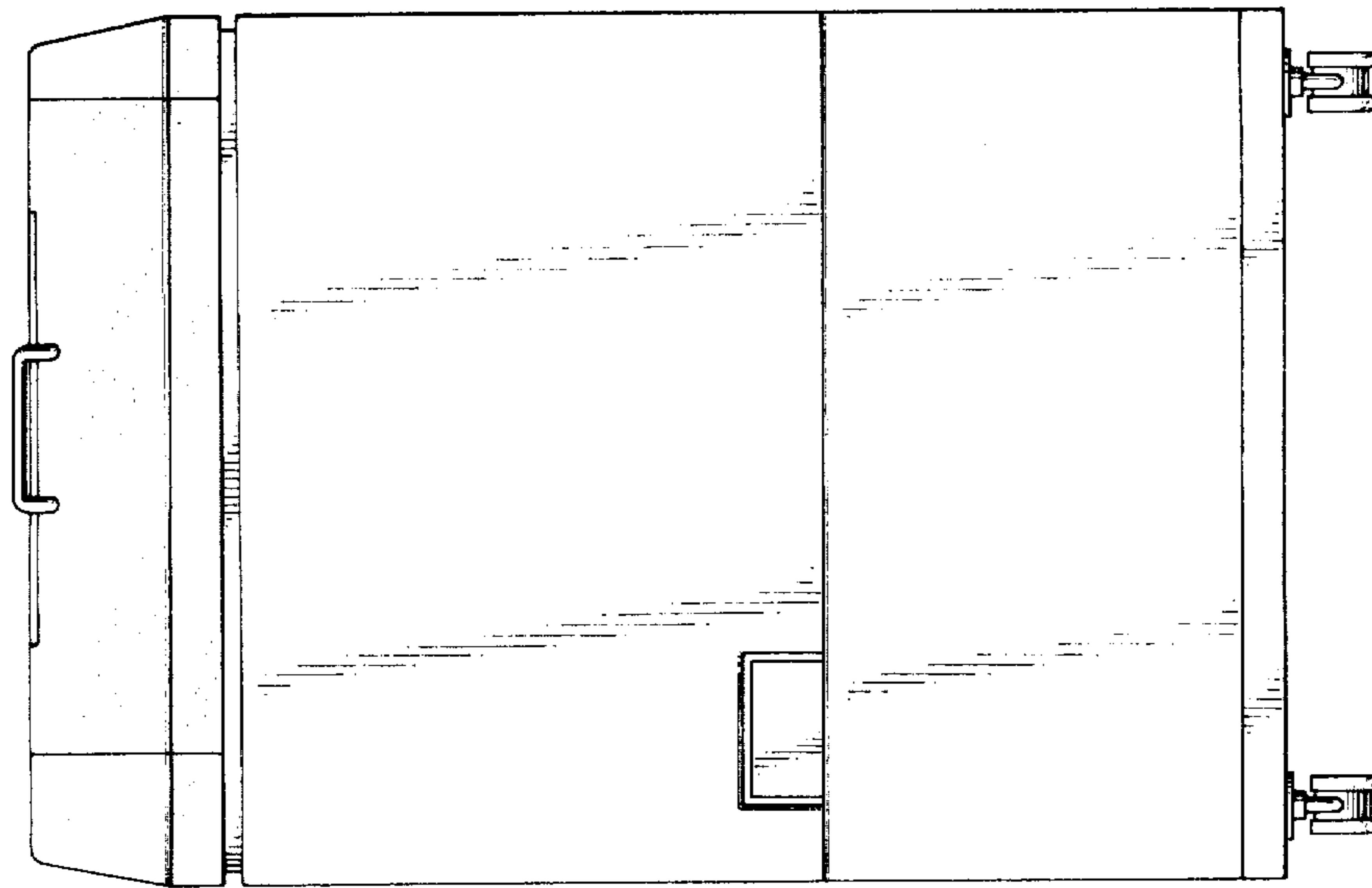

FIG. 4

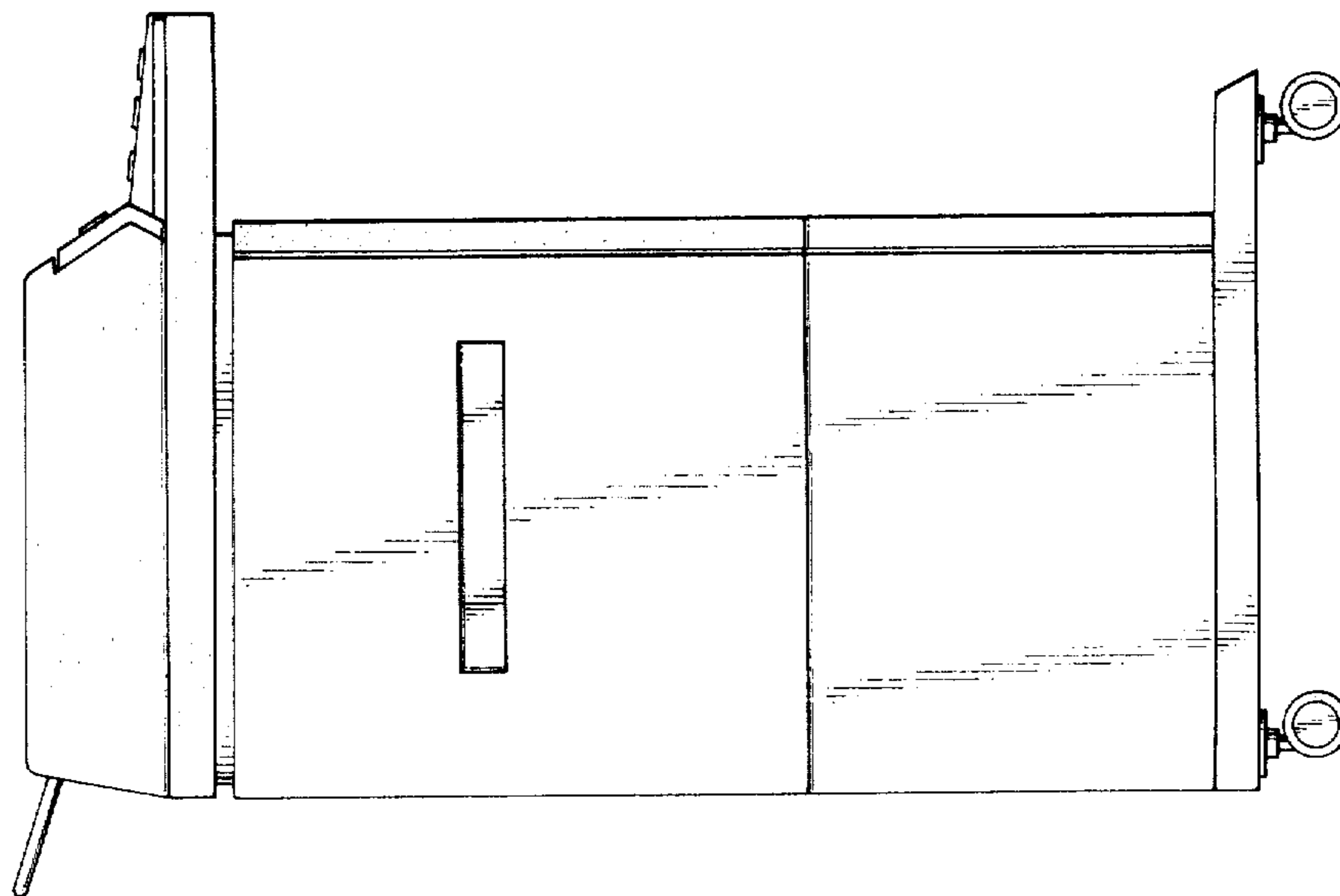

FIG. 7

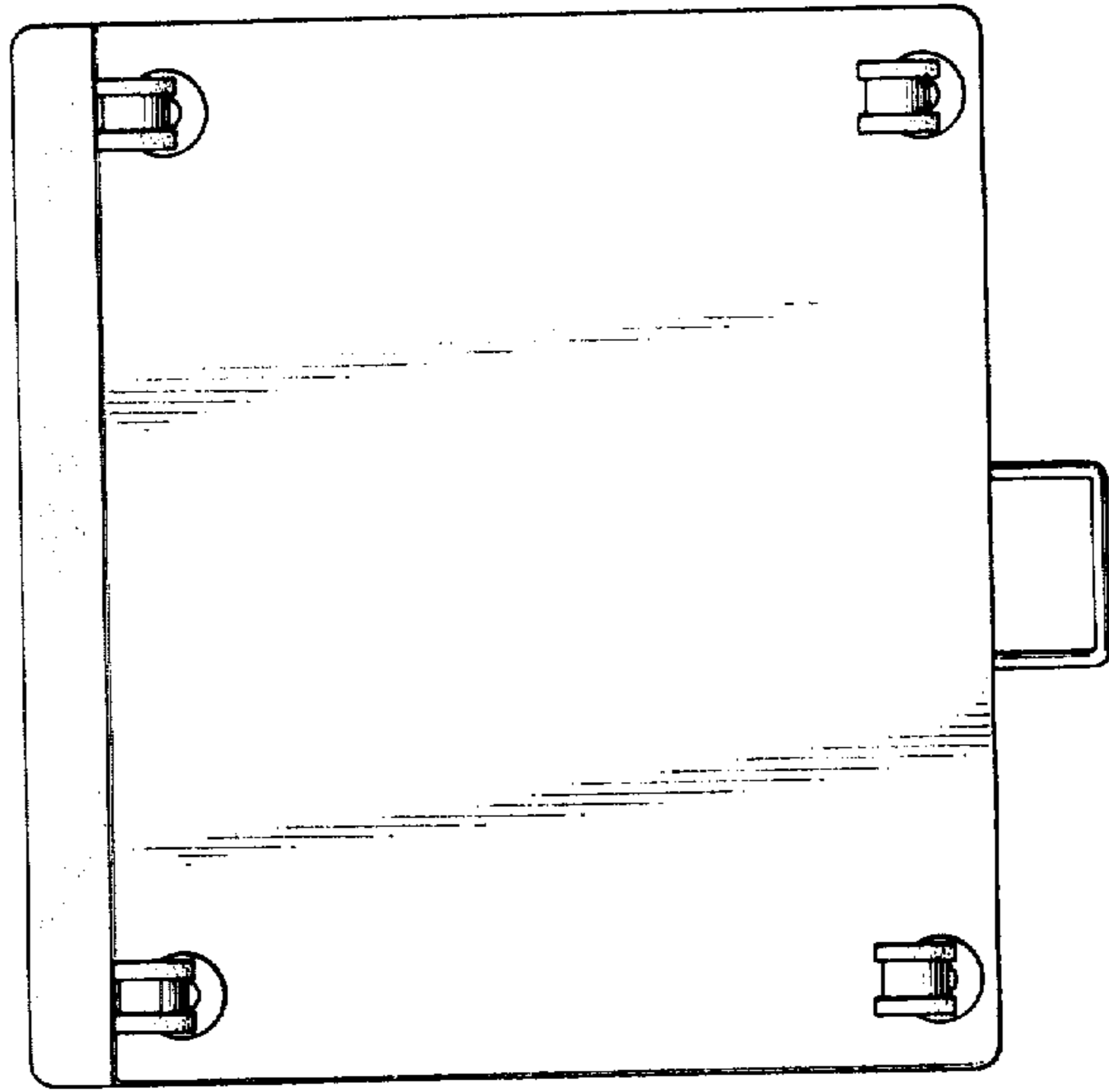

FIG. 6

