

- [54] **TOY DOG IN DOG HOUSE**
- [75] **Inventor:** Ira Gilford, Ridgewood, N.J.
- [73] **Assignee:** Lawrence L. Reiner, Woodbury, N.Y.
- [**] **Term:** 14 Years
- [21] **Appl. No.:** 125,045
- [22] **Filed:** Feb. 27, 1980
- [51] **Int. Cl.** **D21-01**
- [52] **U.S. Cl.** **D21/161; D11/51; D11/158; D21/114**
- [58] **Field of Search** **D11/51, 58; D21/114, D21/161; 46/12, 115, 116**

[56] **References Cited**
U.S. PATENT DOCUMENTS

D. 124,208	12/1940	Silverfield	D11/51
D. 141,038	5/1945	Strauss	D11/51 X
D. 214,384	6/1969	Klamer et al.	D21/161
D. 244,172	5/1977	Lee	D21/114 X

OTHER PUBLICATIONS

Sears Christmas Catalogue, 1967, p. 435, Barking Dog Bank in upper right.

Primary Examiner—Leland A. Sebastian
Attorney, Agent, or Firm—Edward F. Levy

[57] **CLAIM**

The ornamental design for a toy dog in dog house, substantially as shown and described.

DESCRIPTION

FIG. 1 is a front elevational view of a toy dog in dog house showing my new design; FIG. 2 is a right side elevational view thereof; FIG. 3 is a top plan view thereof; FIG. 4 is a rear elevational view thereof; FIG. 5 is a bottom plan view thereof, and FIG. 6 is a left side exploded perspective view thereof. In the FIG. 2, FIG. 3, FIG. 4 and FIG. 6 descriptions the rope is shown as broken away for convenience of illustration.

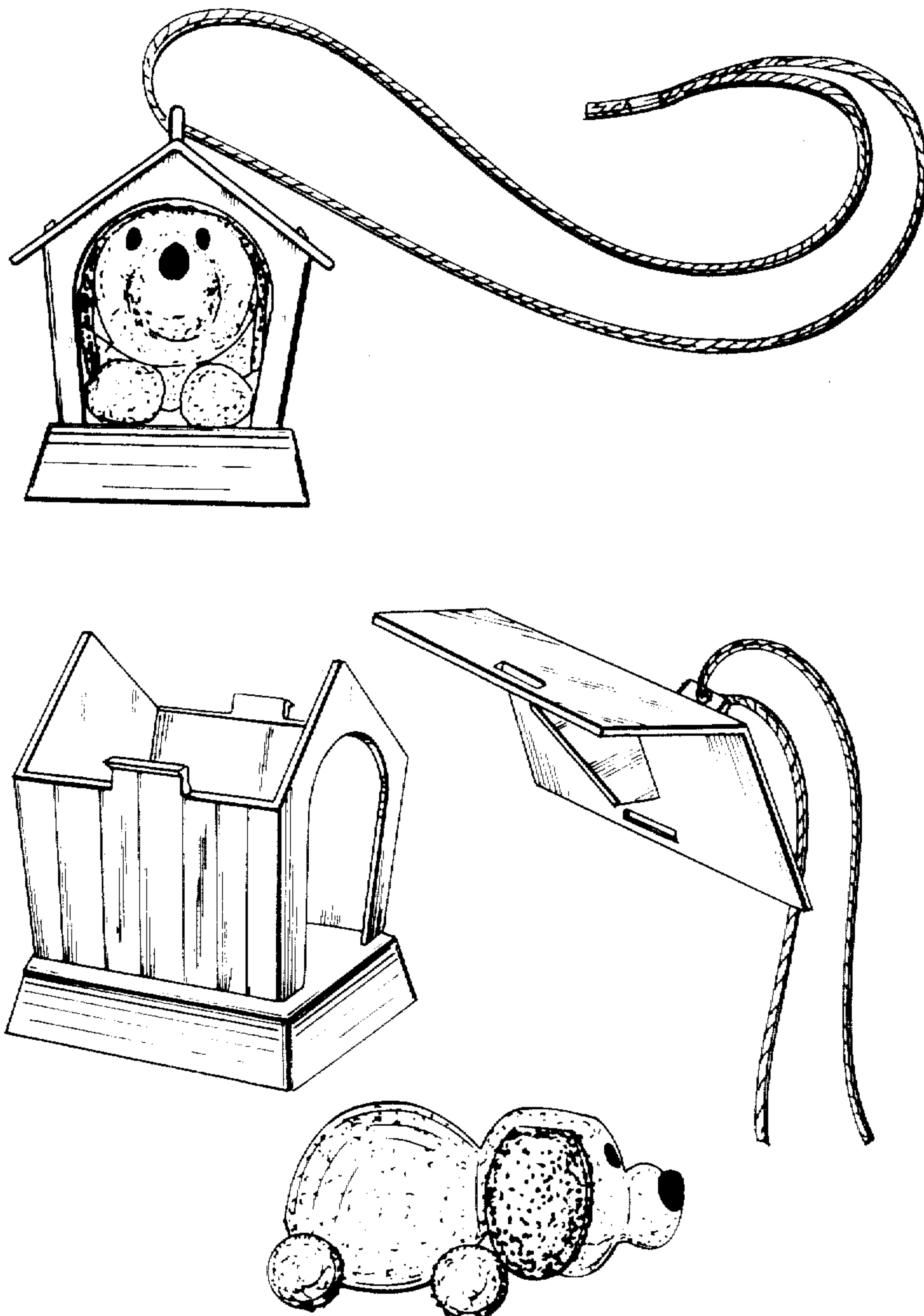

FIG. 1

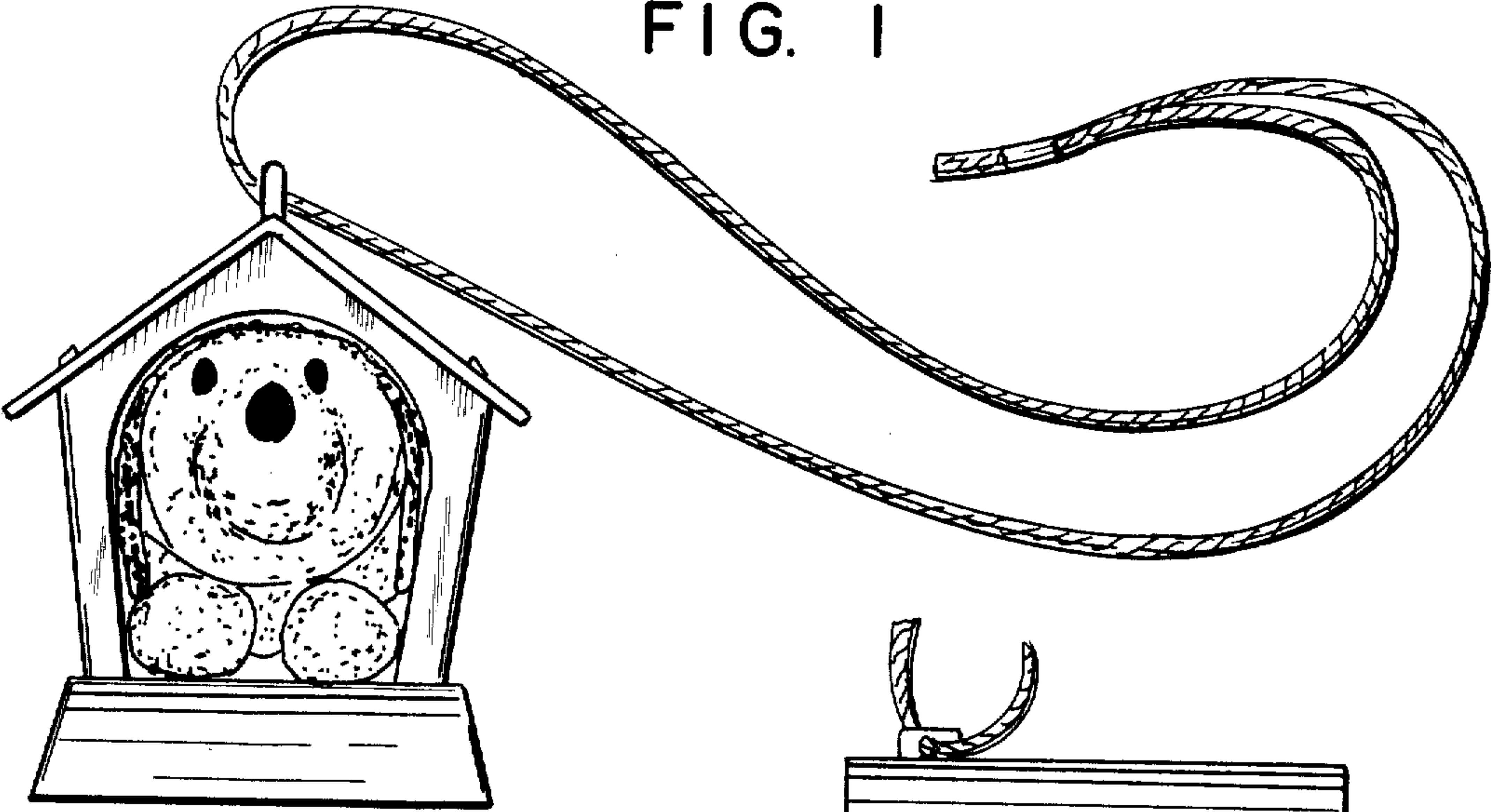

FIG. 2

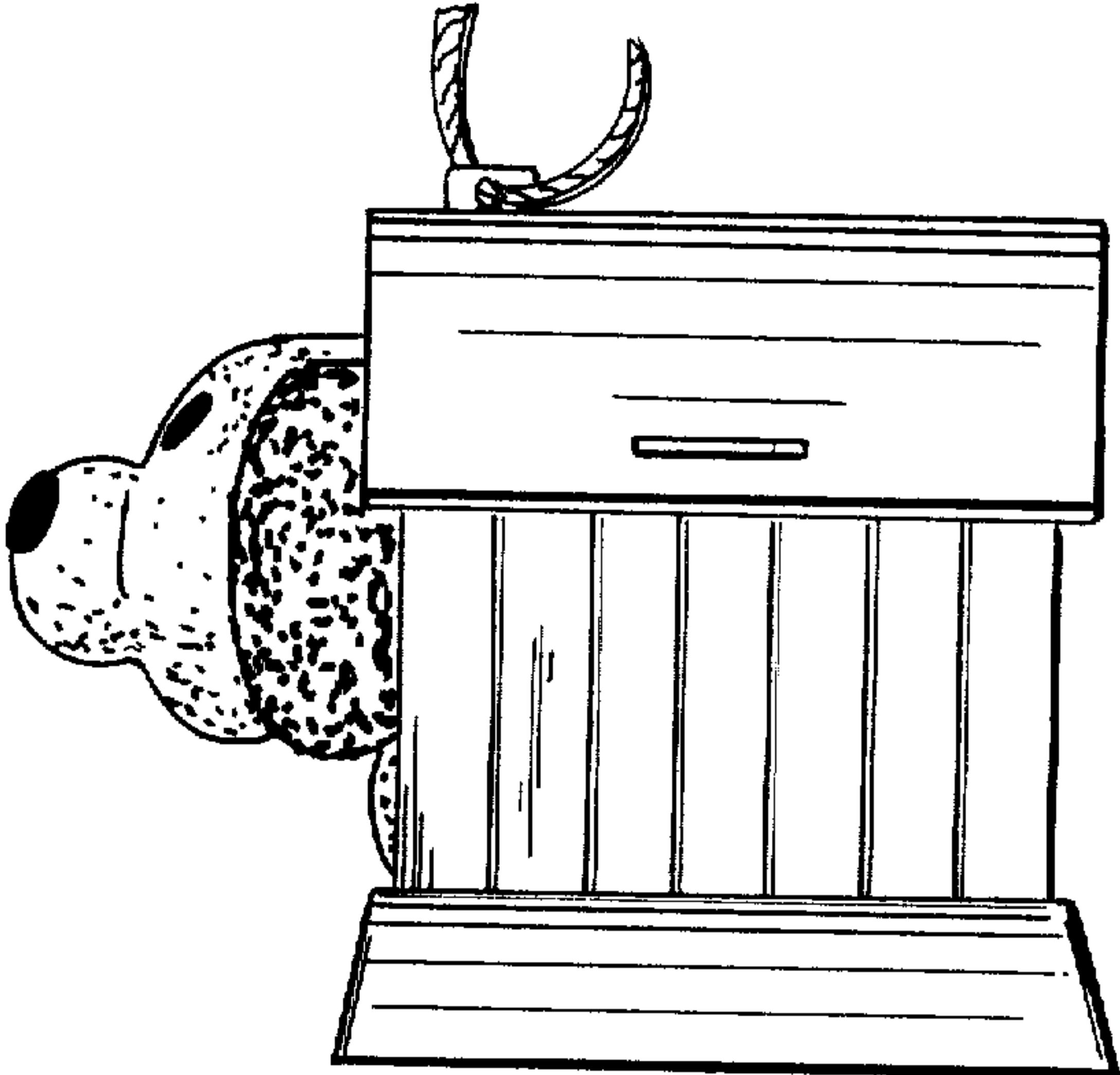

FIG. 3

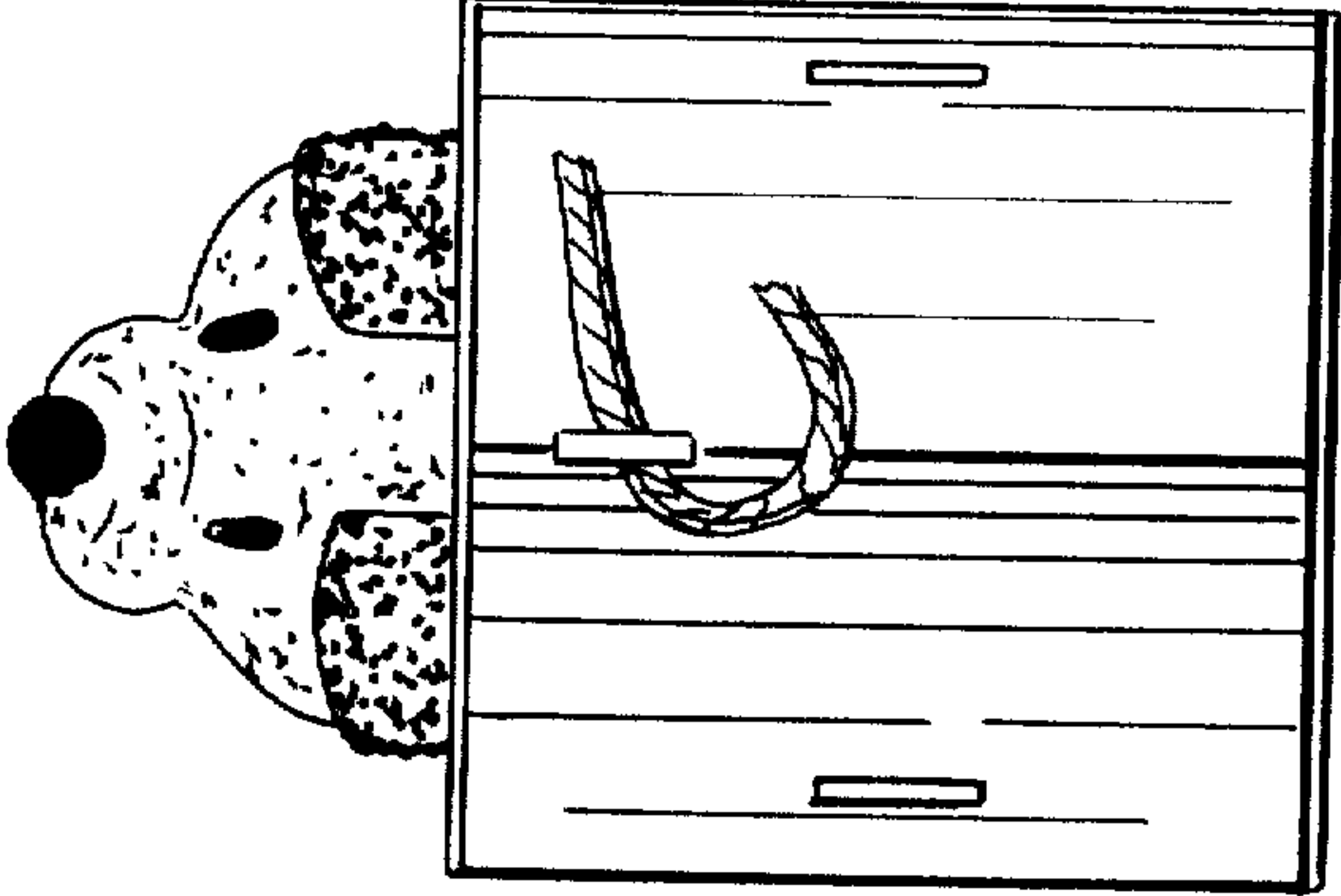

FIG. 4

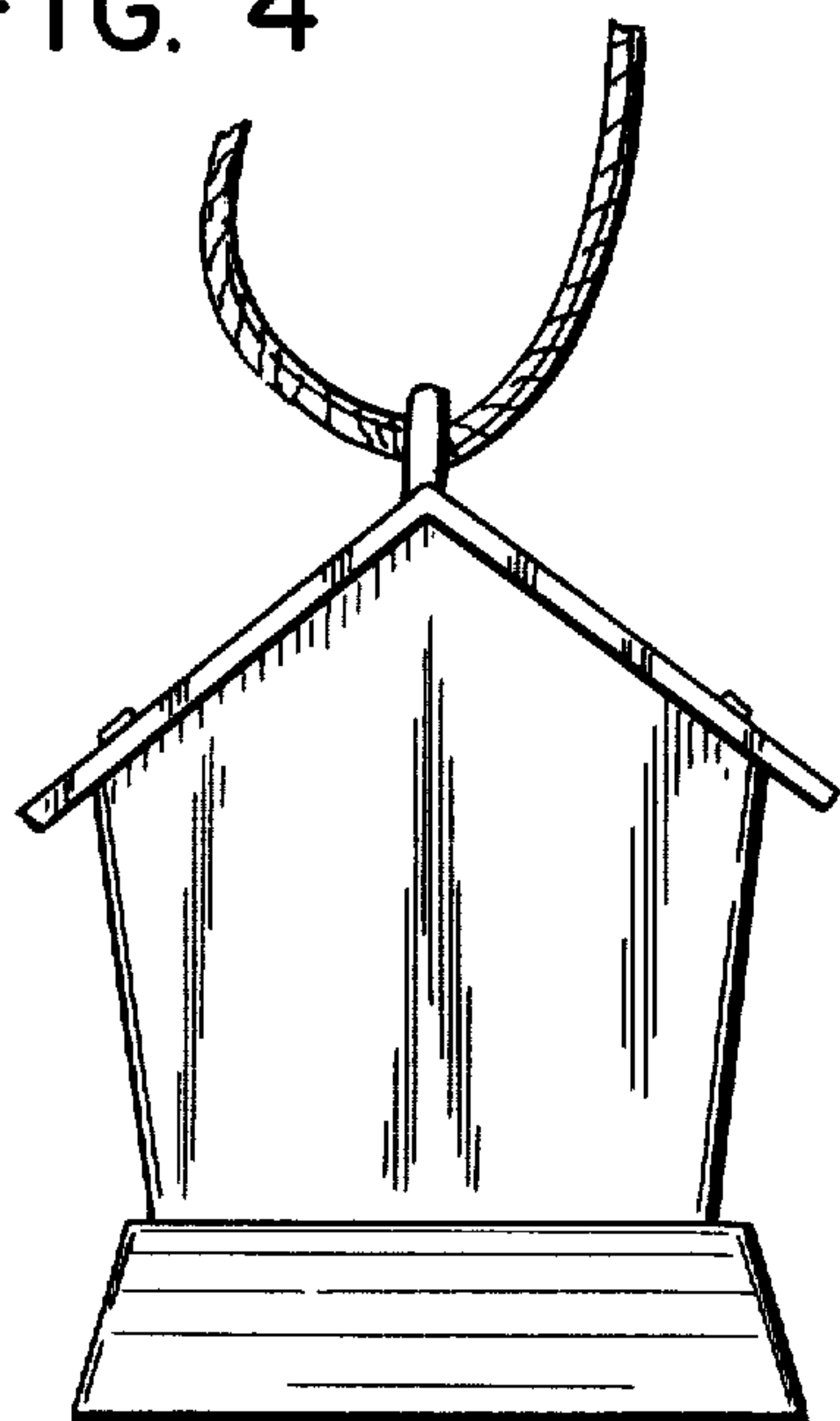

FIG. 5

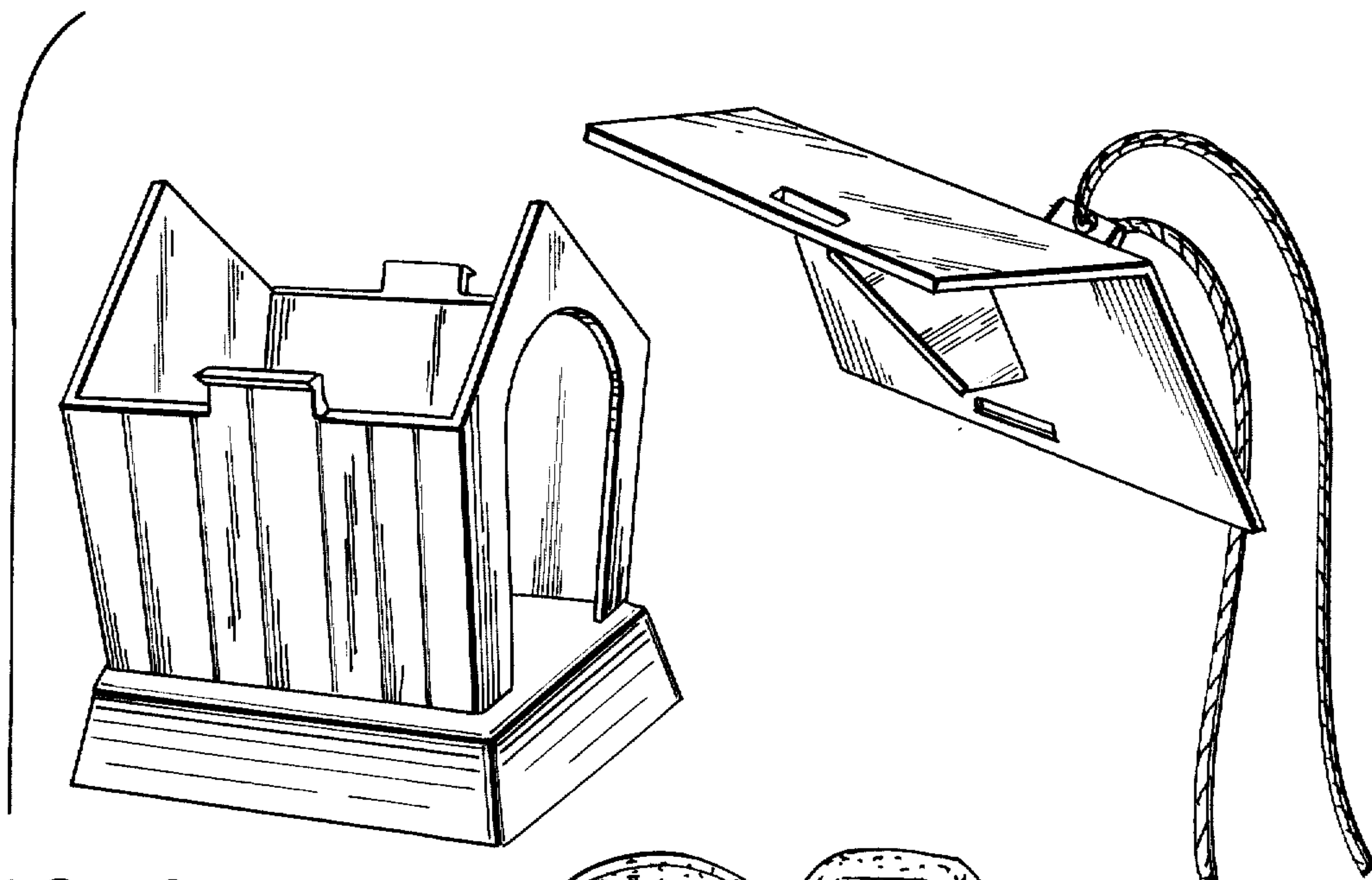
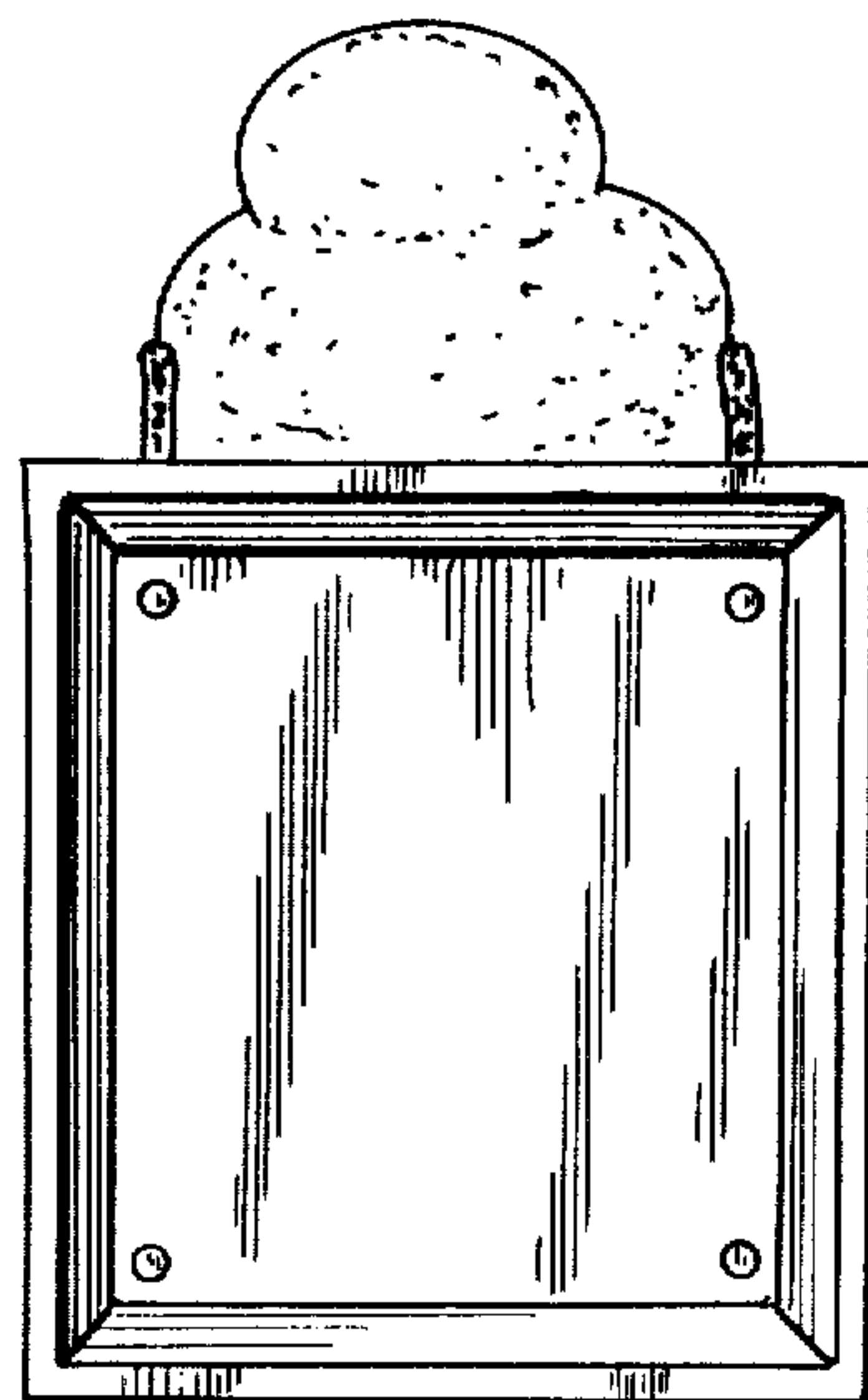

FIG. 6

