

[54] COMBINED TOOTHPASTE DISPENSER,
TOOTHBRUSH AND TUMBLER HOLDER

3,204,823 9/1965 Watson, Jr. 222/93
4,010,871 3/1977 Broadie 222/93

[76] Inventor: Masahiro Iwamoto, 358,
Hiraoka-cho, Sakai-shi, Osaka-fu,
Japan

Primary Examiner—B. J. Bullock
Attorney, Agent, or Firm—Wenderoth, Lind & Ponack

[**] Term: 14 Years

[57] CLAIM

[21] Appl. No.: 136,454

The ornamental design for a combined toothpaste dispenser, toothbrush and tumbler holder, as shown and described.

[22] Filed: Mar. 31, 1980

DESCRIPTION

[51] Int. Cl. D23—02

[52] U.S. Cl. D6/87; D6/91;
D6/92; D6/93; D6/94

[58] Field of Search D6/86, 87, 91, 92, 94;
248/108, 109; 222/93, 95, 99, 100, 101, 105, 106

FIG. 1 is a front view of a combined toothpaste dispenser, toothbrush and tumbler holder, showing the new design;

FIG. 2 is a rear view thereof;

FIG. 3 is a side view taken from the right of FIG. 1 thereof;

FIG. 4 is a side view taken from the left of FIG. 1 thereof;

FIG. 5 is a top view thereof;

FIG. 6 is a bottom view thereof; and

FIG. 7 is a perspective view thereof, the tumbler being shown in broken lines for illustrative purposes only.

[56] References Cited

U.S. PATENT DOCUMENTS

D. 194,022	11/1962	Toth	D6/87
2,179,012	11/1939	Kach	222/93
2,548,535	4/1951	Iannone et al.	222/93
3,172,569	3/1965	Wolford	222/105

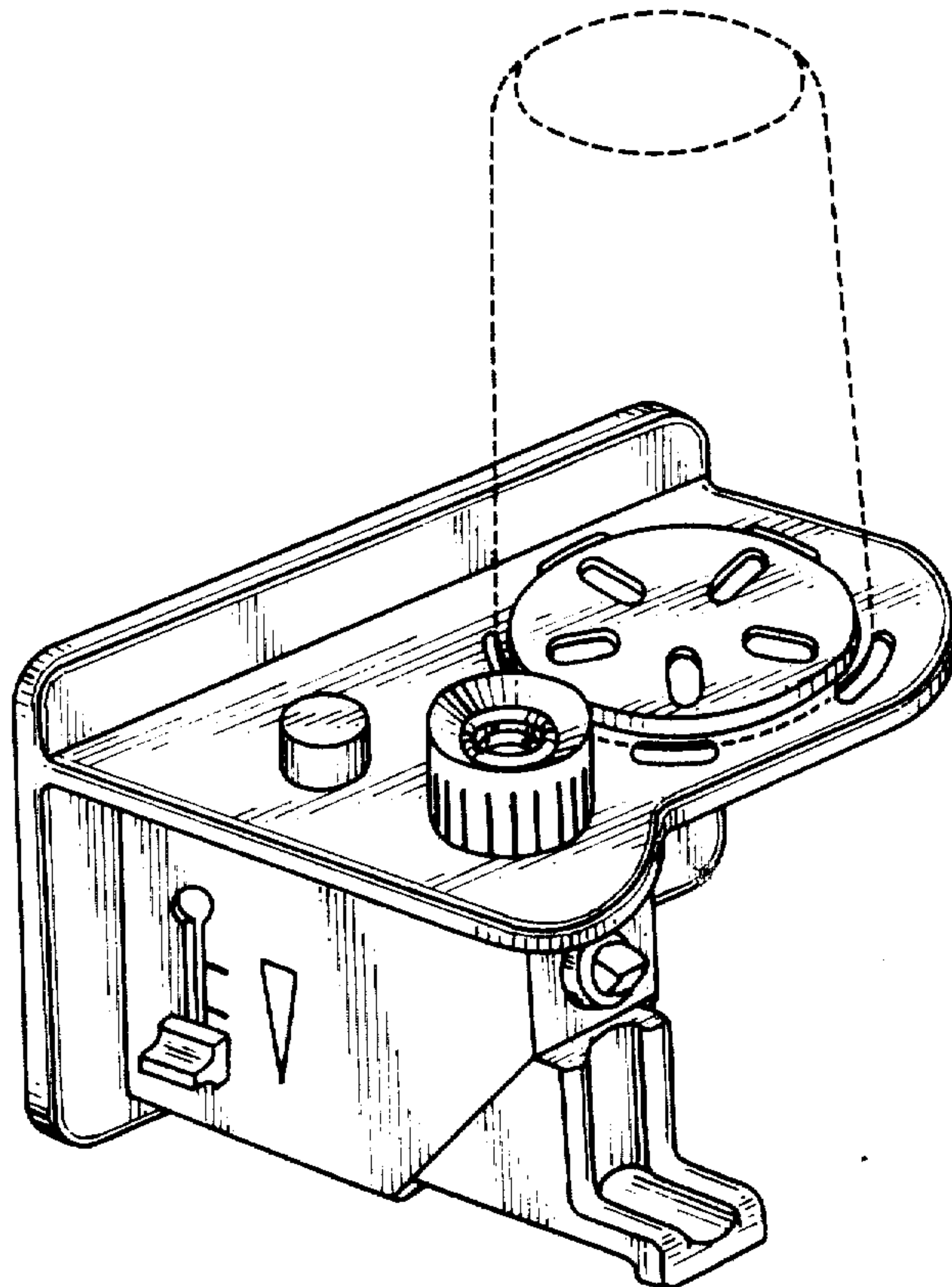

FIG. 1

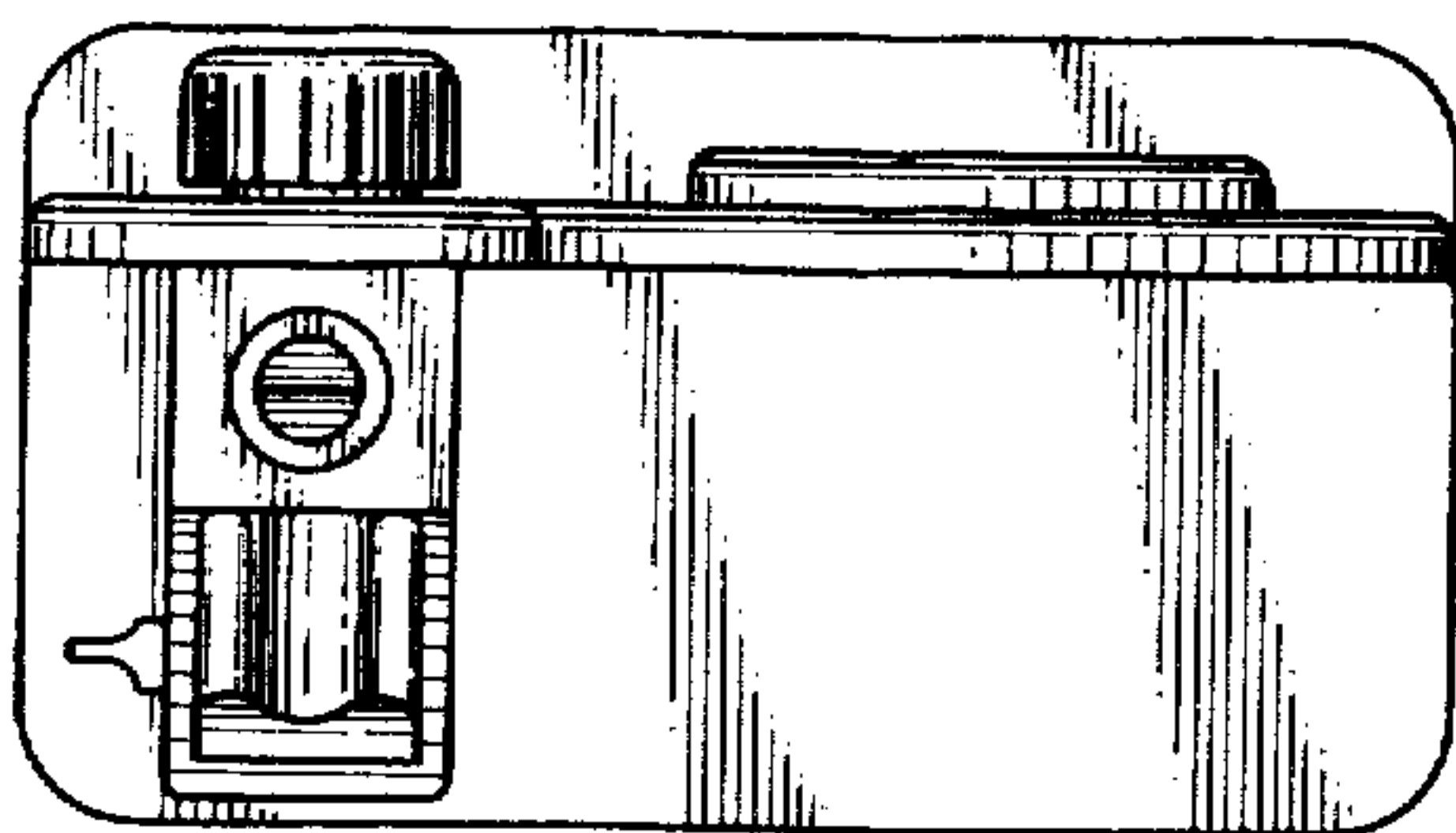

FIG. 2

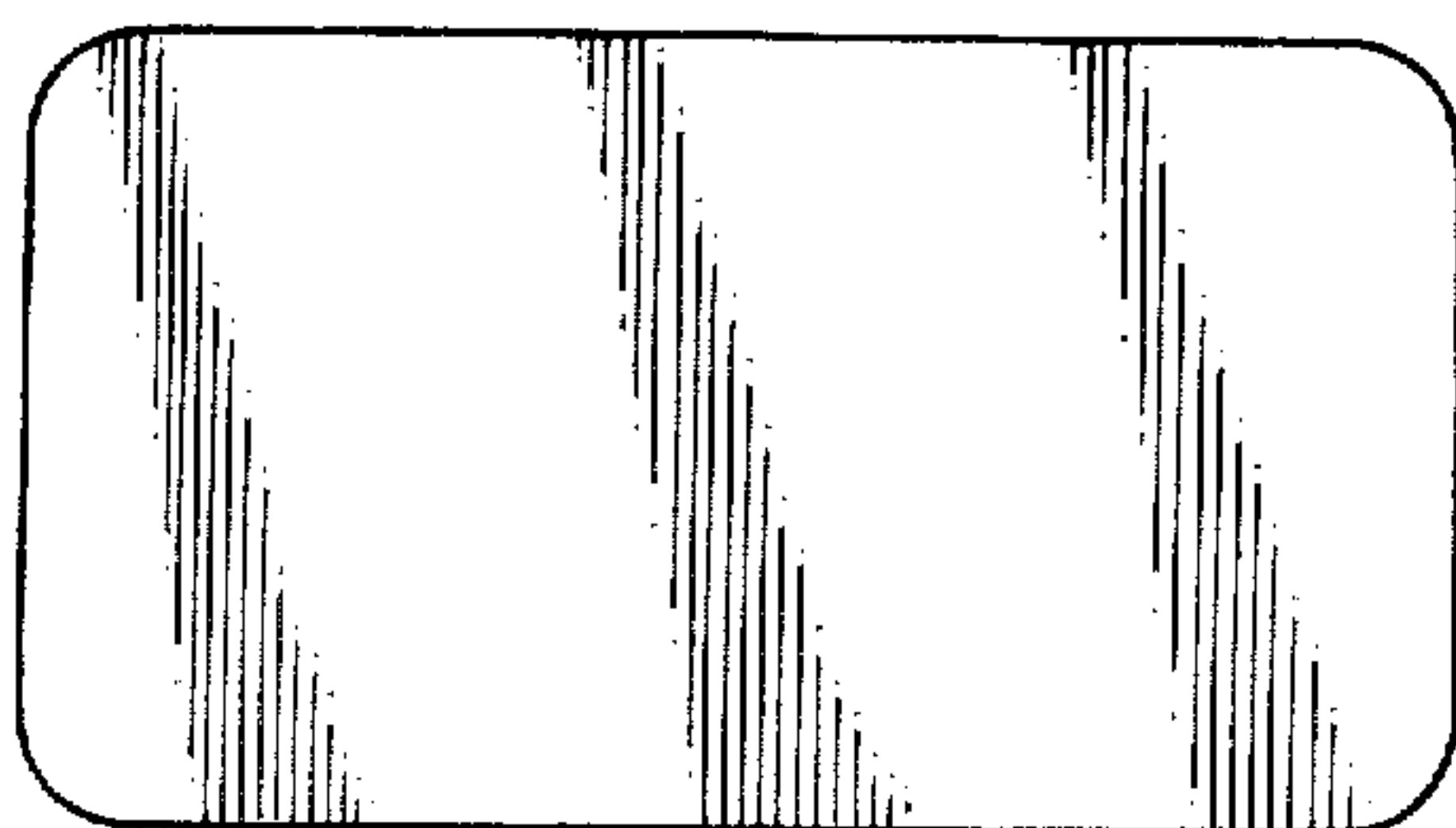

FIG. 3

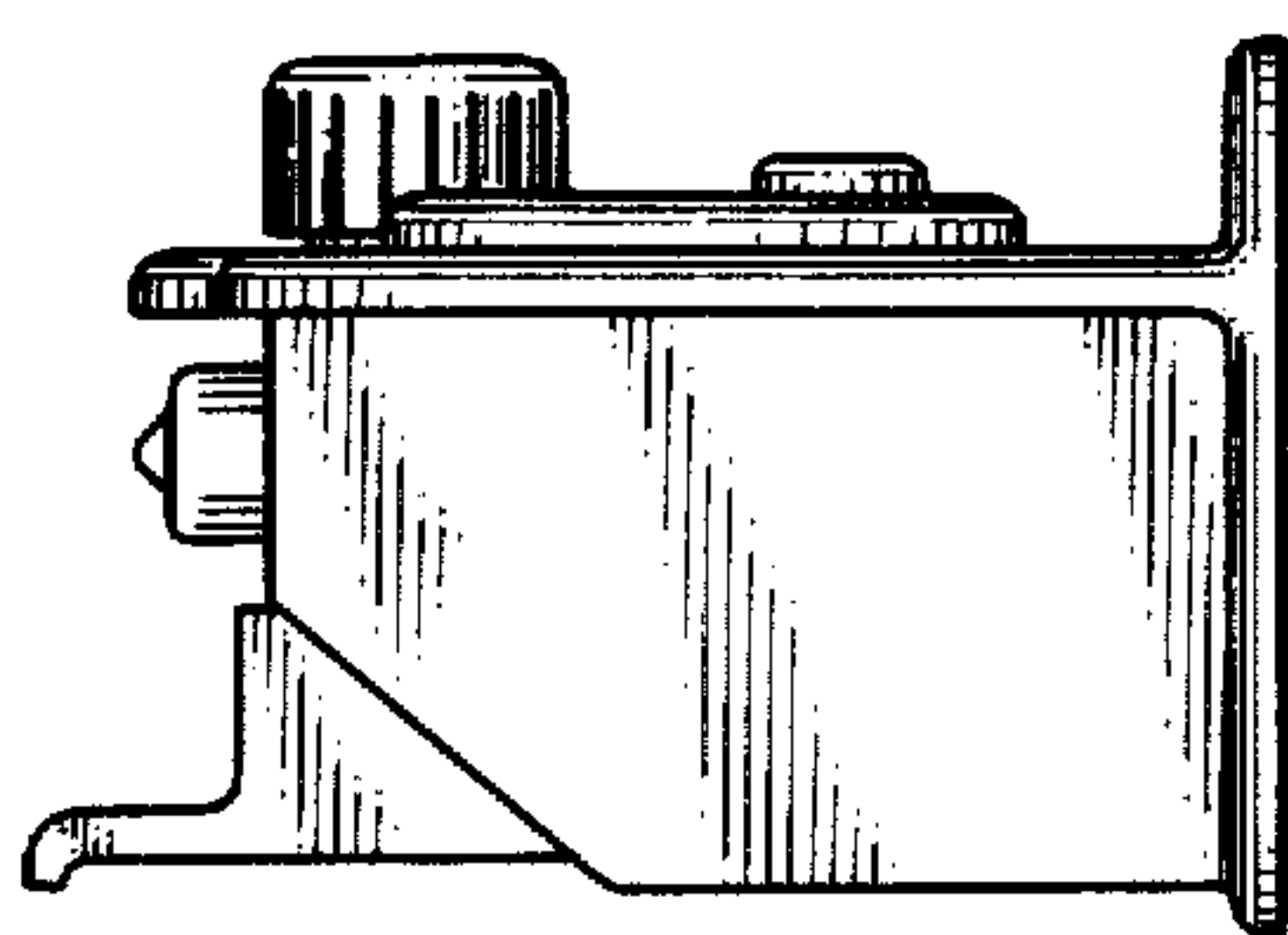

FIG. 4

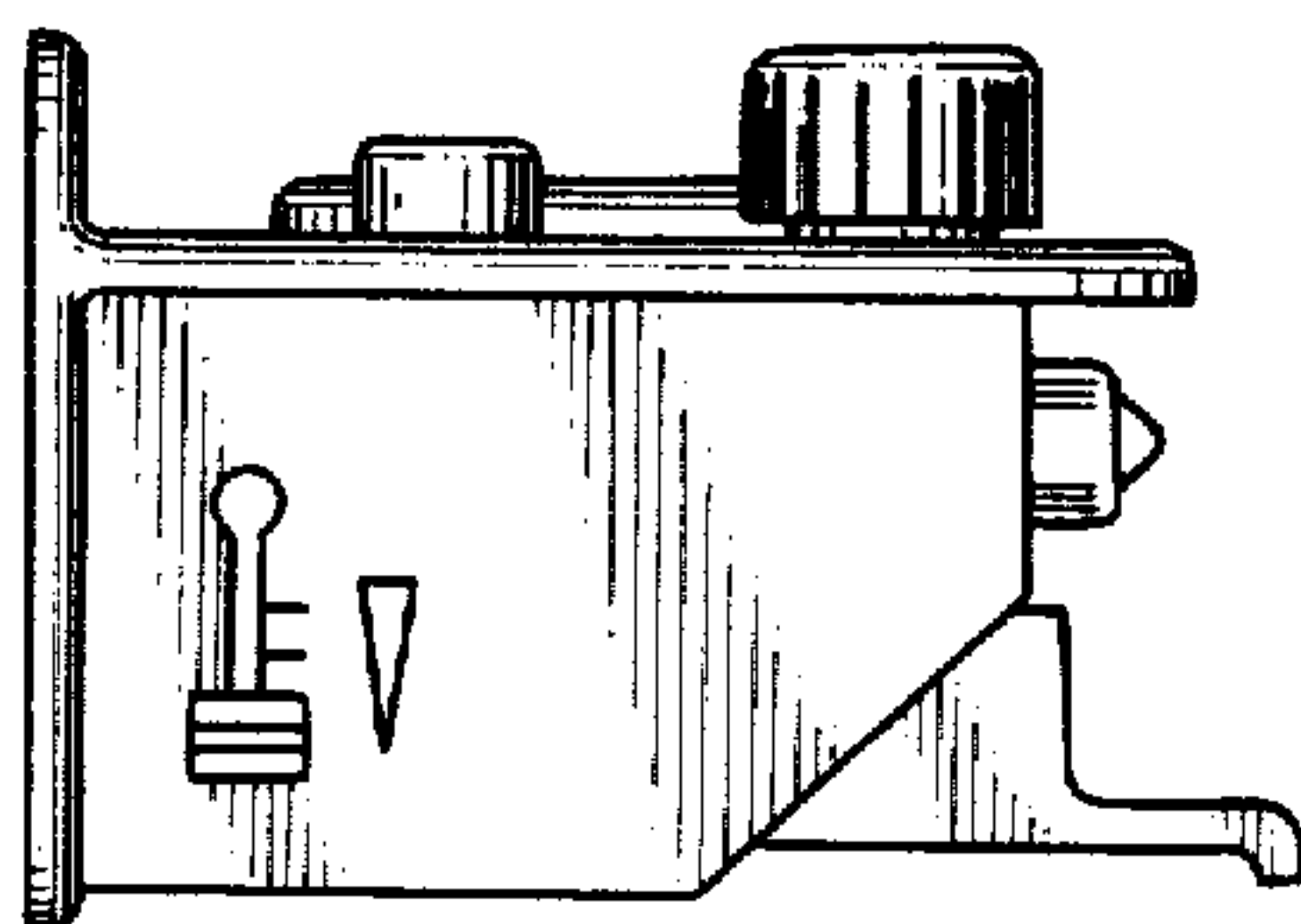

FIG. 5

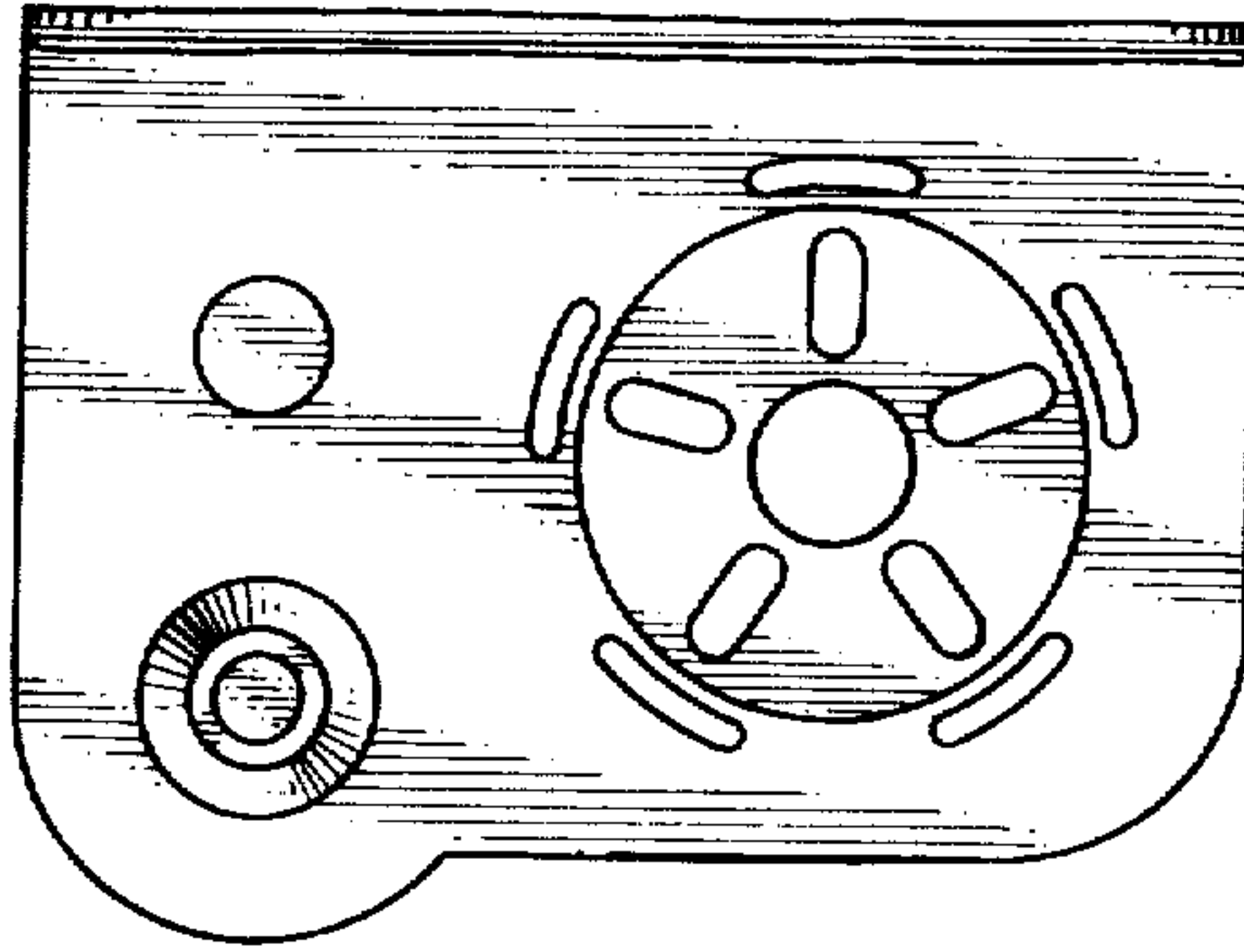

FIG. 6

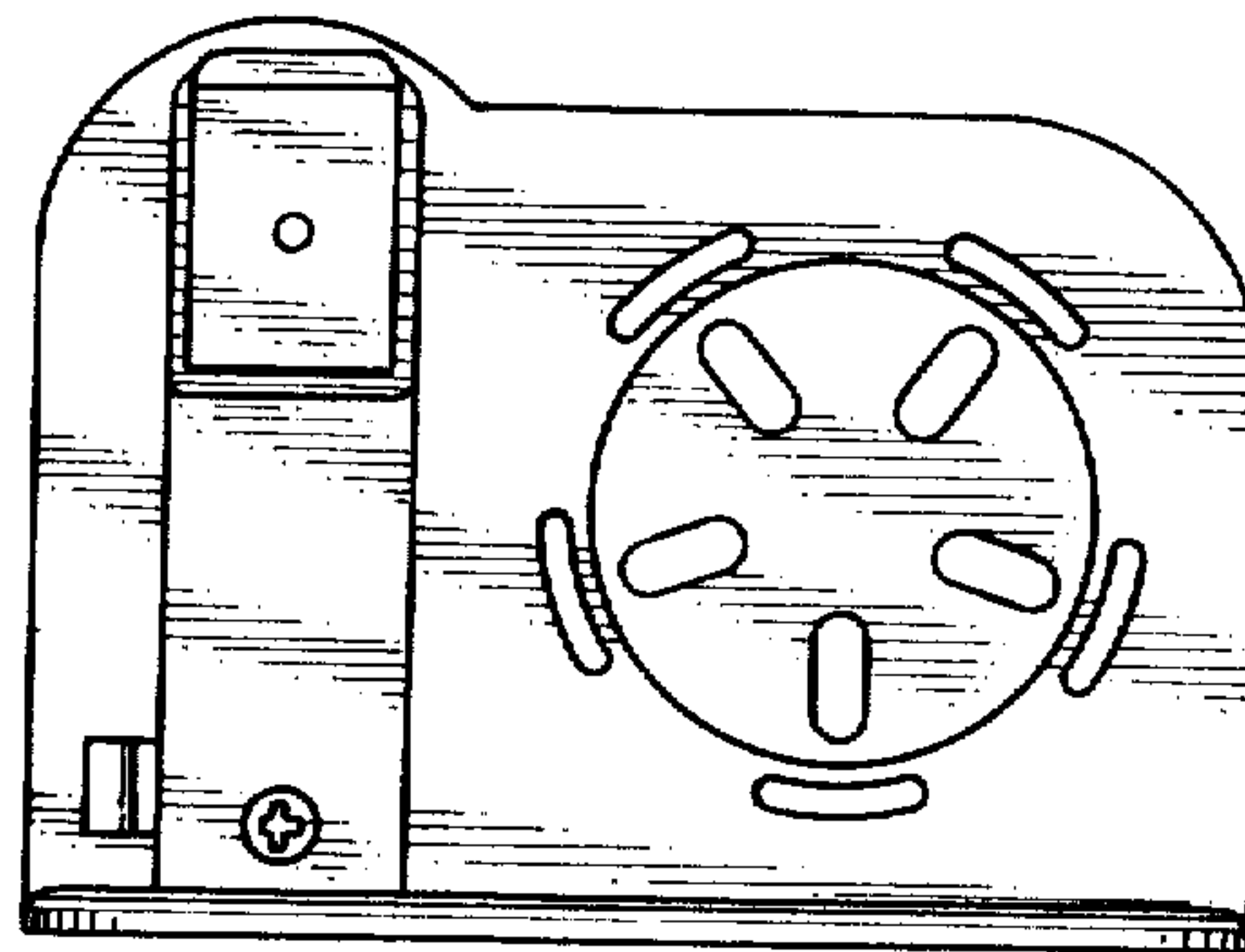

FIG. 7

