

[54] **WEIGHT SCALE**

[75] Inventor: **Arthur Strathman, Denver, Colo.**

[73] Assignee: **Magic Dragon Enterprises,
Westminster, Colo.**

[**] Term: **14 Years**

[21] Appl. No.: **132,877**

[22] Filed: **Mar. 24, 1980**

[51] Int. Cl. **D10-04**

[52] U.S. Cl. **D10/90**

[58] Field of Search **D10/87-94,
D10/83; 177/246; 73/433**

[56] **References Cited**

U.S. PATENT DOCUMENTS

D. 98,977	3/1936	Bennett	D10/90
D. 105,970	9/1937	Powell	D10/90

D. 186,243	9/1959	Moore	D10/83
2,132,736	10/1938	Jones	73/433
3,057,421	10/1962	Fann	177/246 X
3,135,344	6/1964	Olyphant	177/246
3,747,415	7/1973	Nickles	73/433

Primary Examiner—Nelson C. Holtje
Attorney, Agent, or Firm—Sheridan, Ross & McIntosh

[57] **CLAIM**

The design for a weight scale, as shown and described.

DESCRIPTION

FIG. 1 is a side elevational view of a weight scale showing my new design;
FIG. 2 is a front elevational view thereof;
FIG. 3 is a top plan view thereof;
FIG. 4 is a bottom plan view thereof;
FIG. 5 is a rear elevational view thereof;
FIG. 6 is a perspective view thereof; and
FIG. 7 is a perspective view of a cover portion thereof.

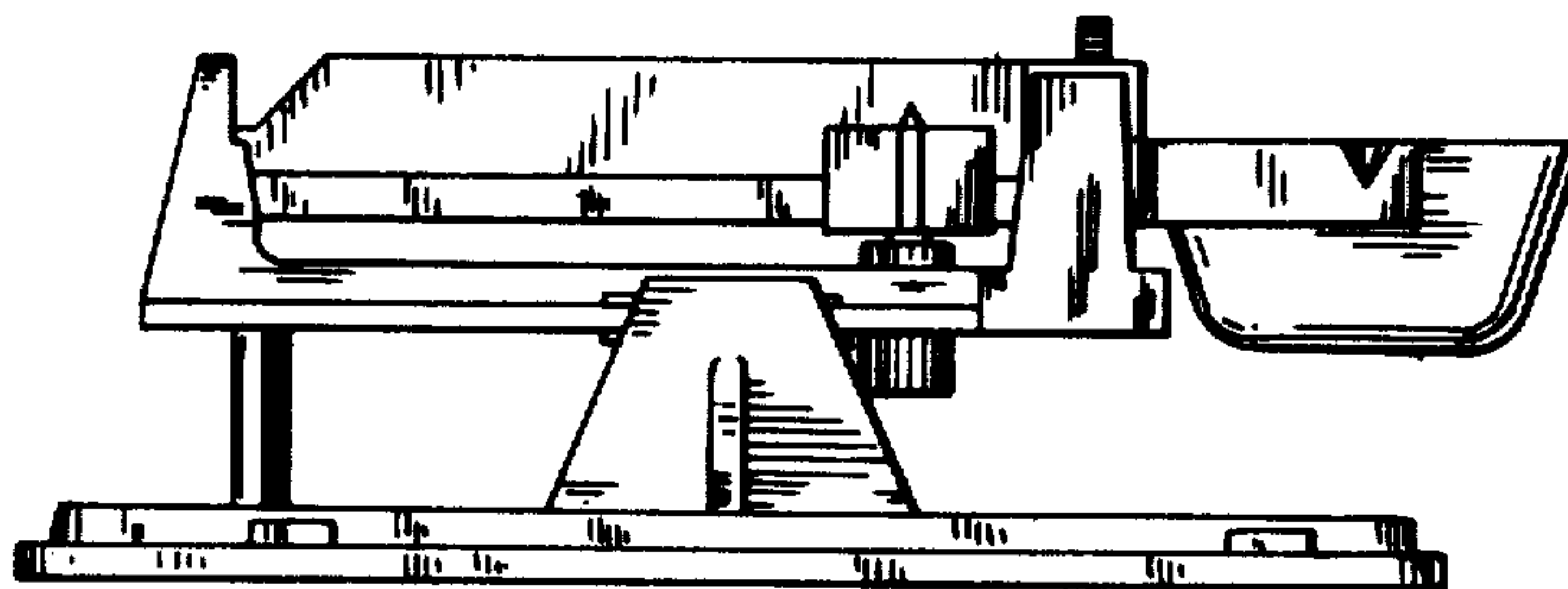

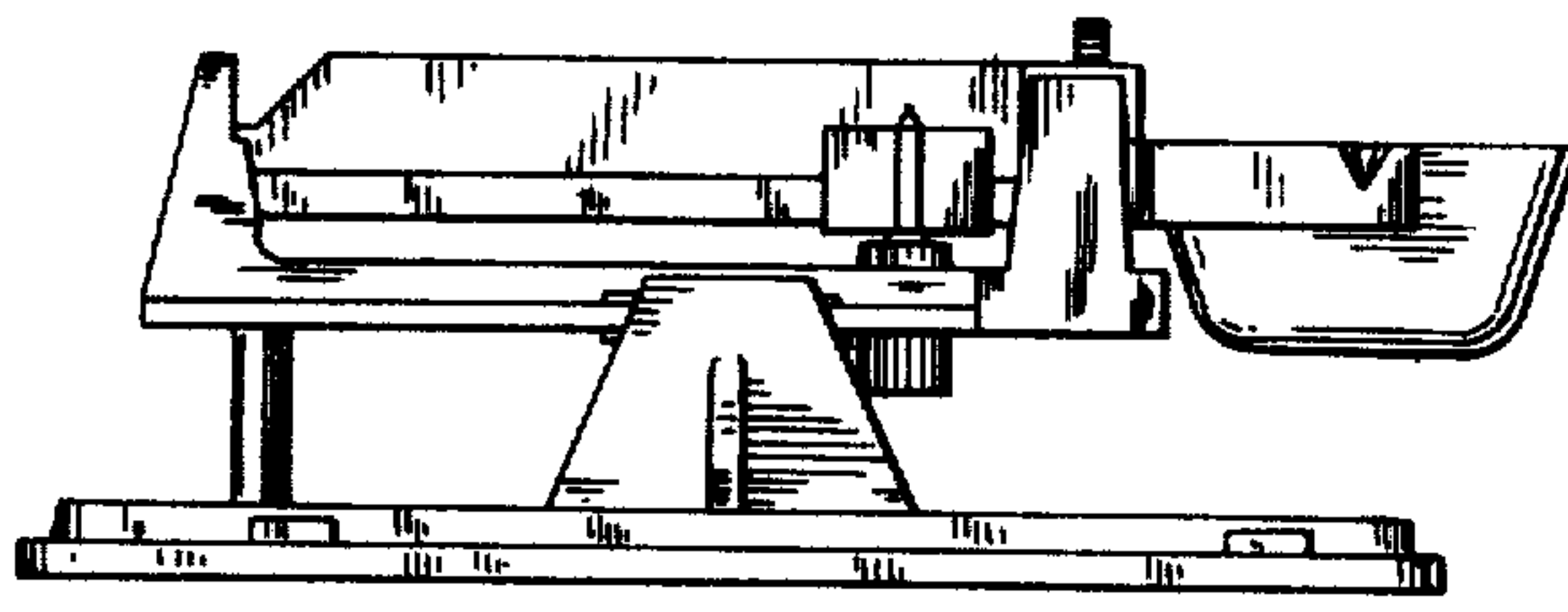

Fig. 1

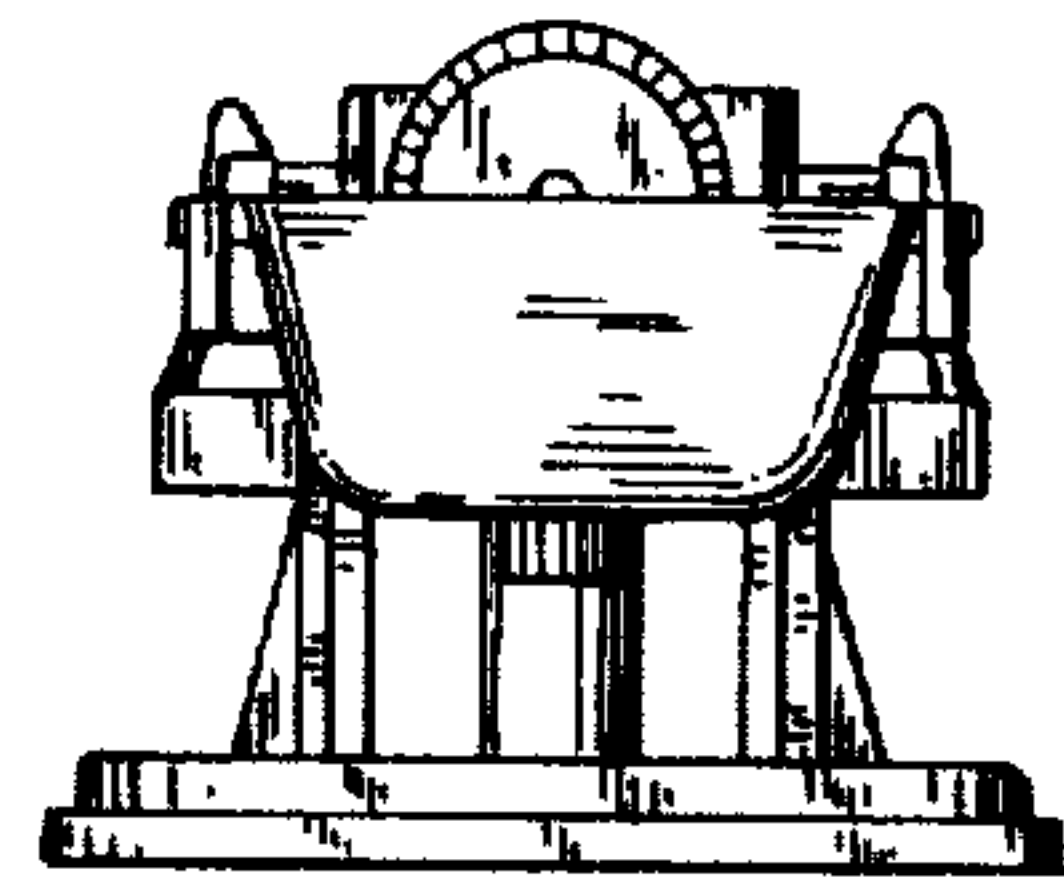

Fig. 2

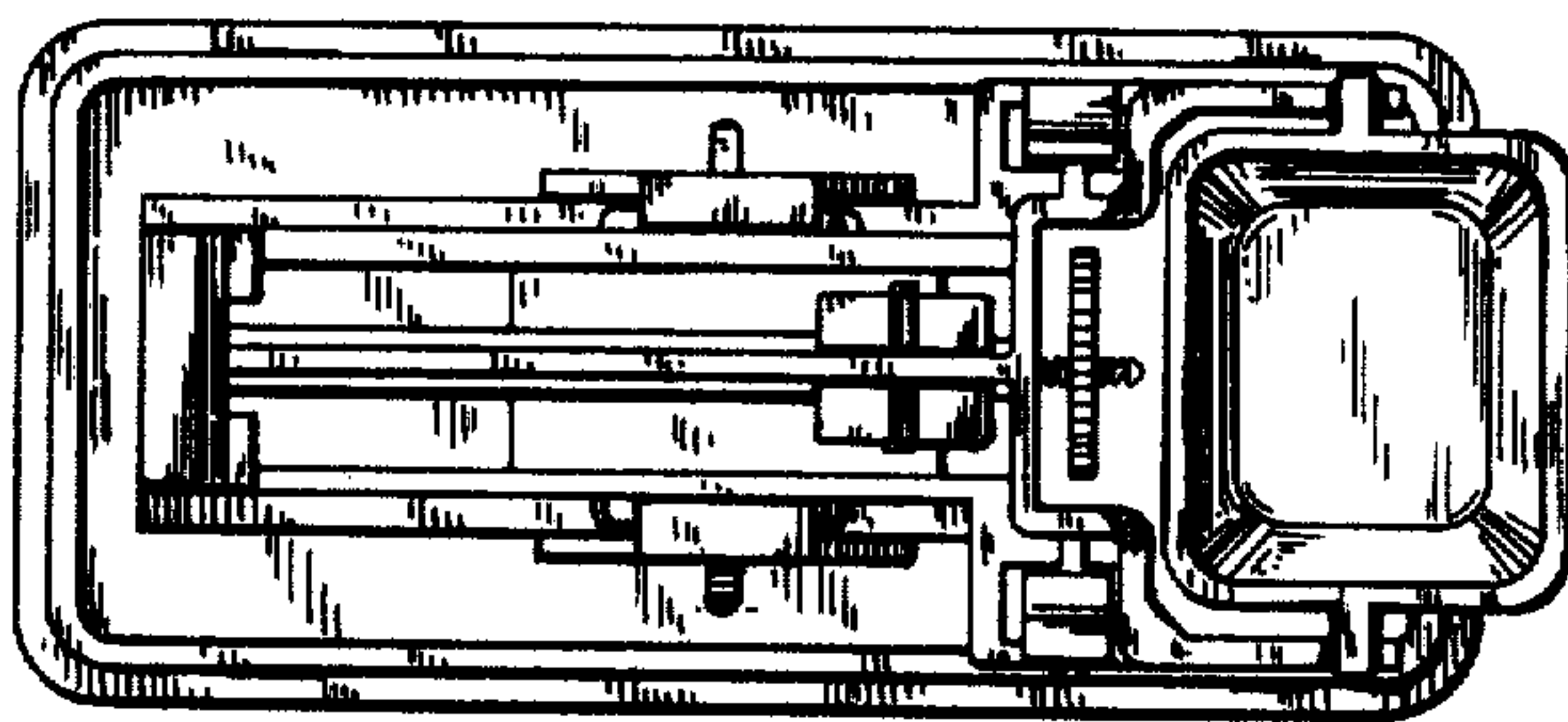

Fig. 3

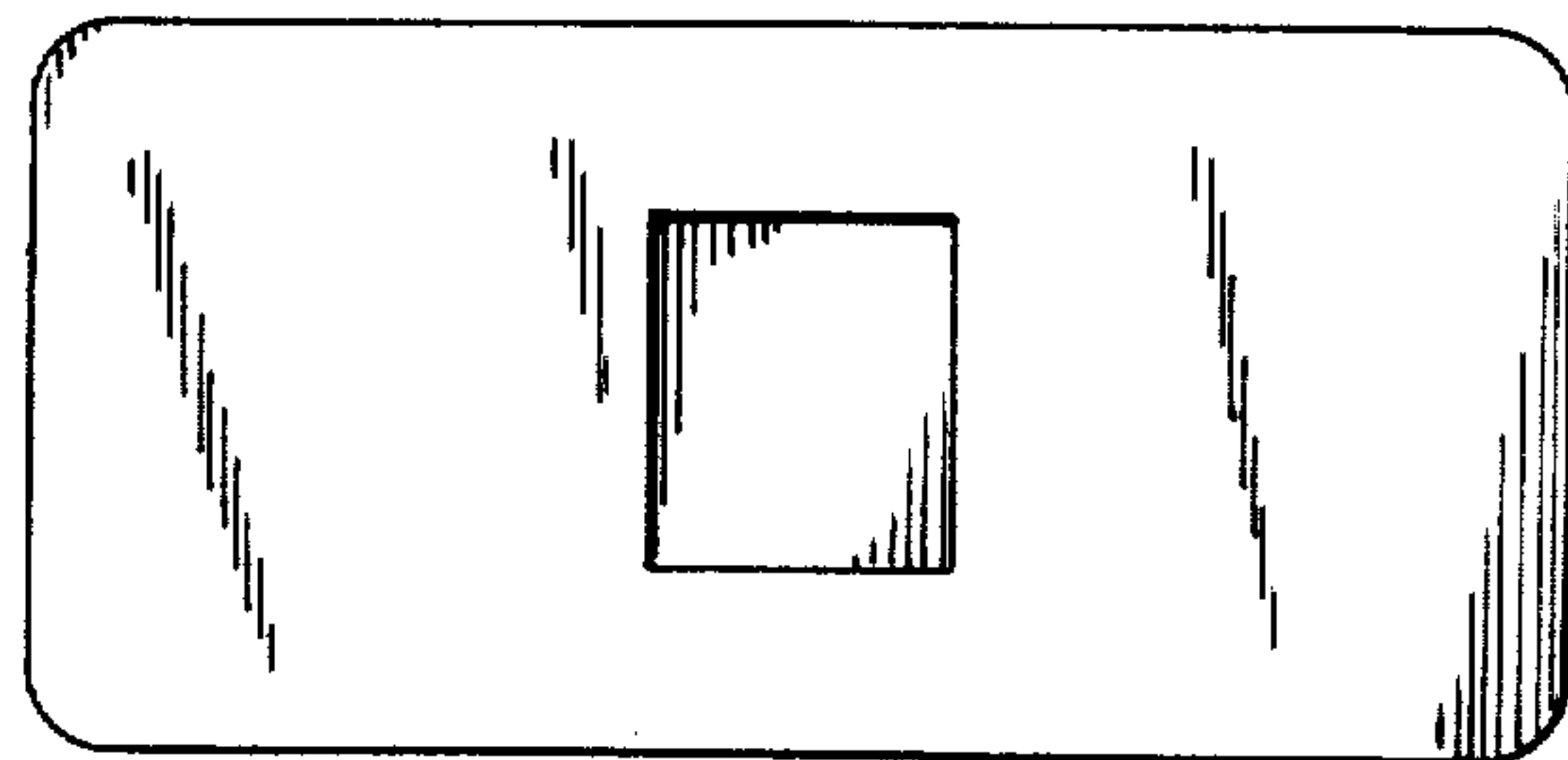

Fig. 4

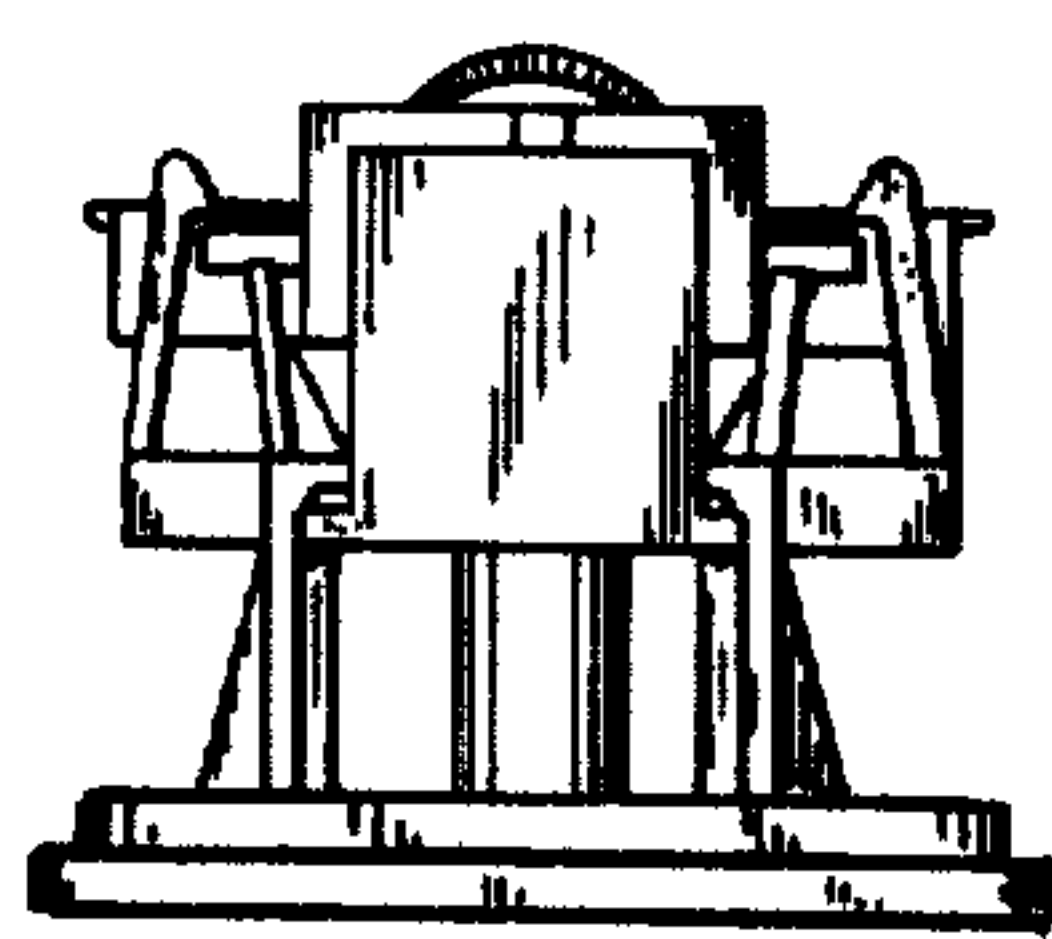

Fig. 5

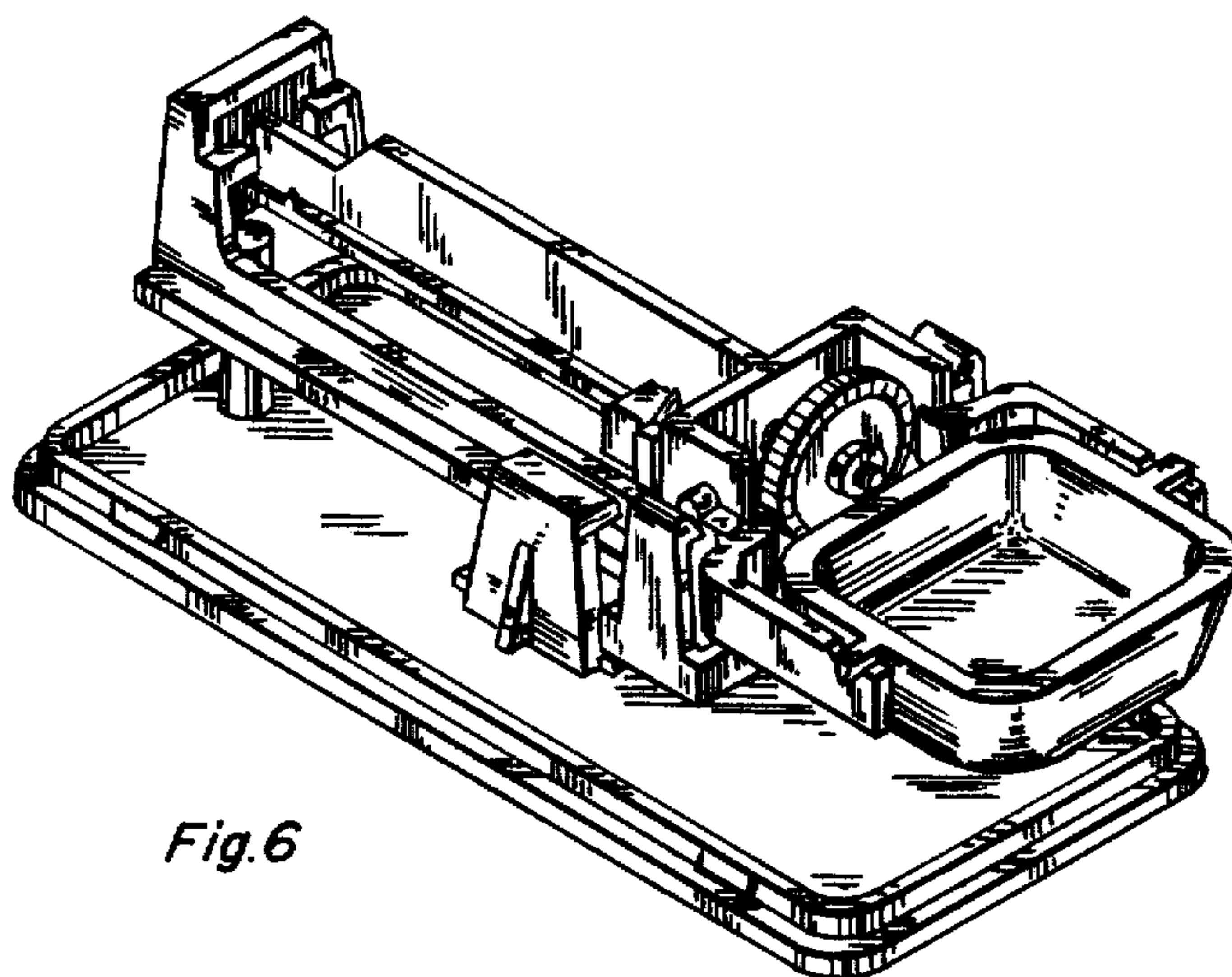

Fig. 6

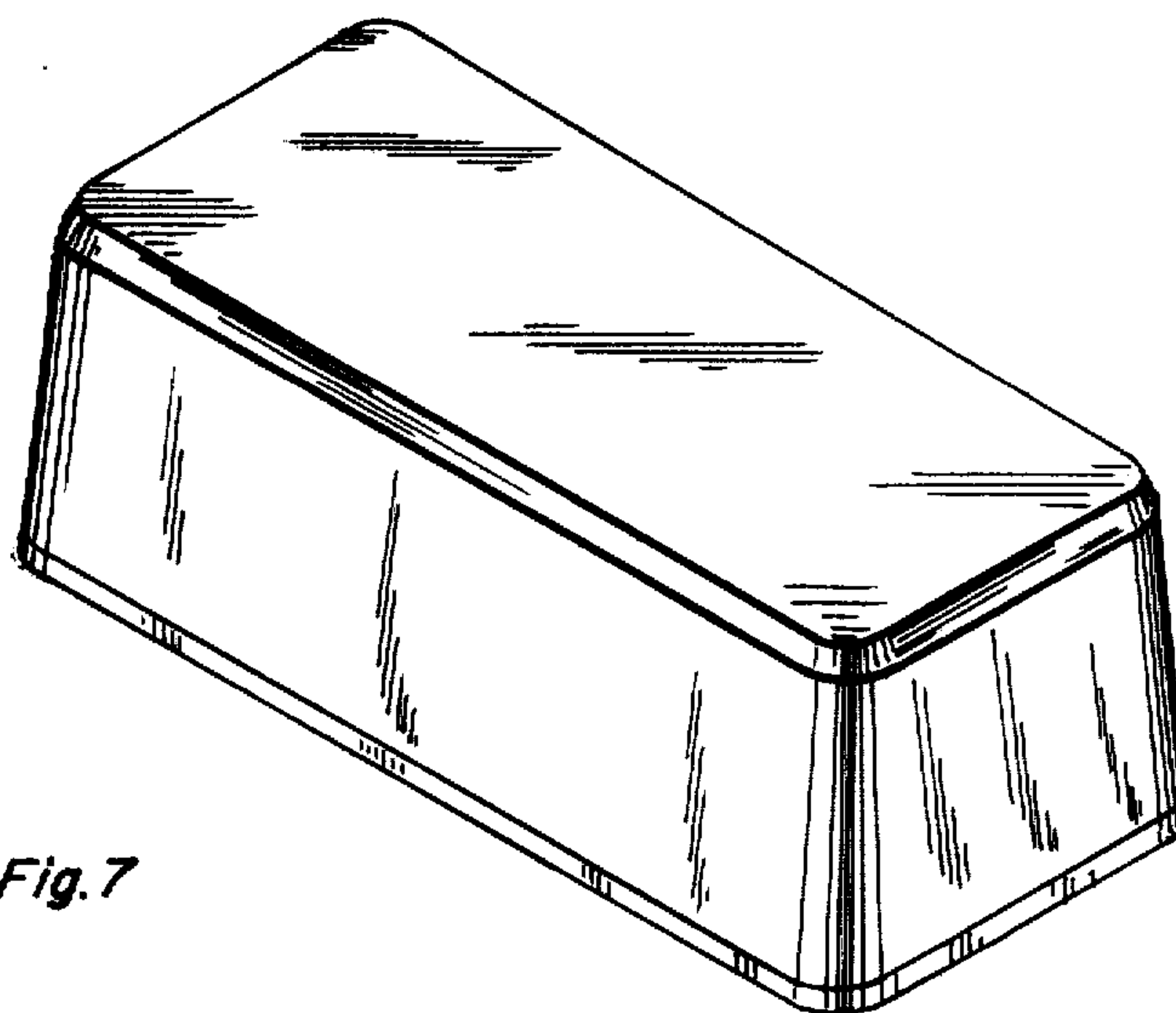

Fig. 7