

[54] PORTABLE MULTIPLE-TOILET BUILDING

[76] Inventor: William A. Reynolds, 328 Walnut La., Youngstown, N.Y. 14174

[**] Term: 14 Years

[21] Appl. No.: 99,314

[22] Filed: Dec. 3, 1979

[51] Int. Cl. D25-03

[52] U.S. Cl. D25/1; D25/16; D25/33; D25/48; D25/63

[58] Field of Search 52/66, 68, 70, 71, 79.1, 52/79.5; D25/1, 16, 17, 18, 33, 48, 63, 459, 460, 461, 462

[56] References Cited

U.S. PATENT DOCUMENTS

- D. 211,081 5/1968 Barnhart D25/16
- D. 250,350 11/1978 Sargent et al. D25/16
- 3,566,554 3/1971 Schaffer et al. D25/22 X
- 3,775,919 12/1973 Fulton D25/33 X

Primary Examiner—A. Hugo Word
Attorney, Agent, or Firm—Donald C. Studley

[57] CLAIM

The ornamental design for a portable multiple-toilet building, as shown and described.

DESCRIPTION

FIG. 1 is a perspective view of a portable multiple-toilet building embodying my new design, this view showing

the front and right side with the toilet compartment doors closed;

FIG. 2 is a perspective view of said building showing the right side and rear thereof;

FIG. 3 is an elevational view of the right side of said building with the toilet compartment door thereon open 90 degrees, the left side view being a mirror-image thereof;

FIG. 4 is a perspective view of the rear and part of the right side of said building, with the nearer of the two privacy wings removed and a fragment of the rear wall broken out to disclose the interior portion of the urinal room thereof;

FIG. 5 is a top plan view of the building with the toilet compartment doors closed;

FIG. 6 is a top sectional view of the building taken along the line 6-6 of FIG. 3, with the toilet compartment doors shown open 45 degrees;

FIG. 7 is an elevational view of the right side of said building with the urinal room portion shown in the folded-in mode and the steps stored within the toilet compartments and their doors fully closed, the appearance given when being transported;

and FIG. 8 is a perspective view of a portable multiple-toilet building in the folded-in mode and showing the rear and right side thereof.

The bottom of the portable multiple-toilet building embodying my design shown in the drawing is substantially plain and unornamental.

The broken line showing of the turbine ventilator is for illustrative purposes only.

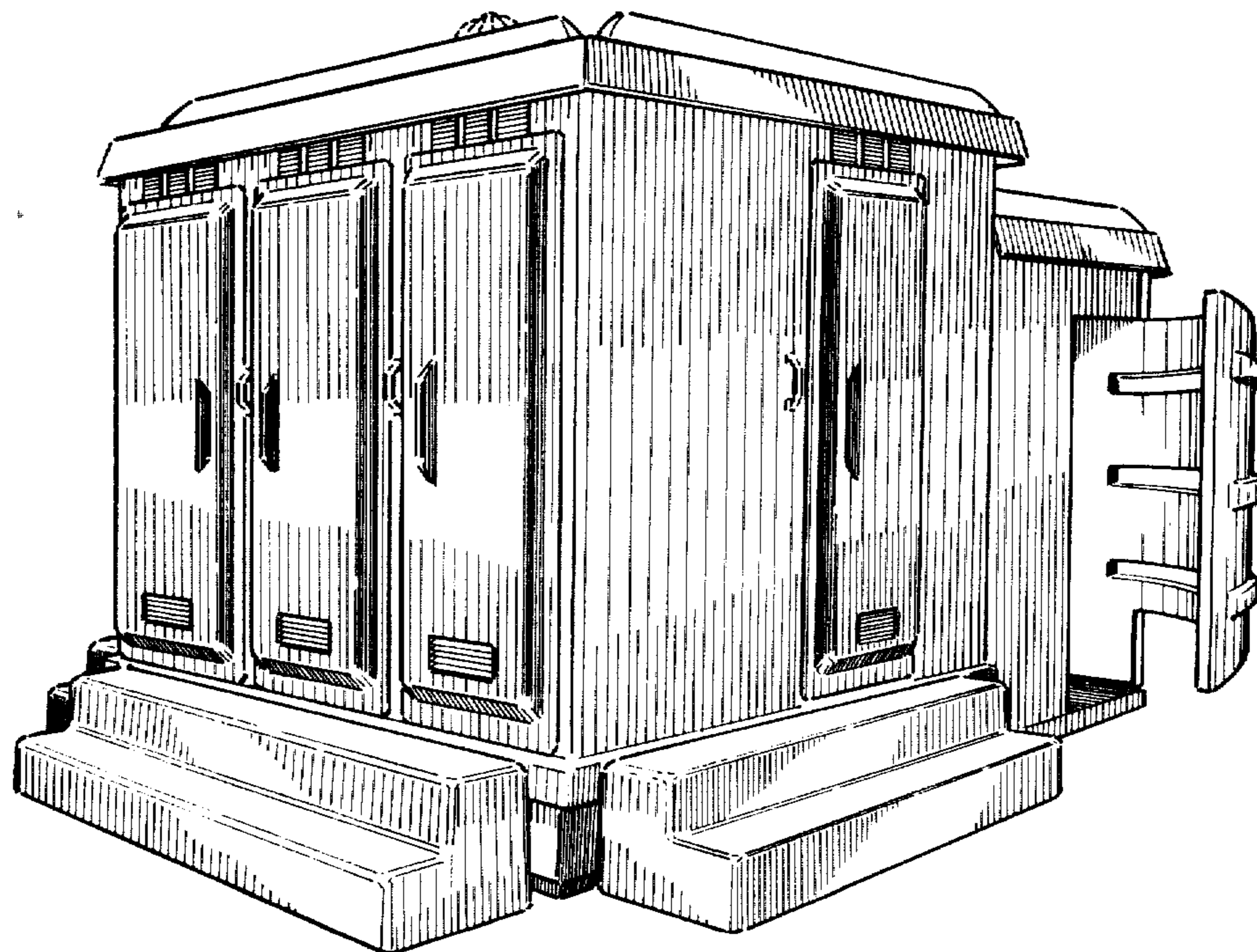

FIG 1

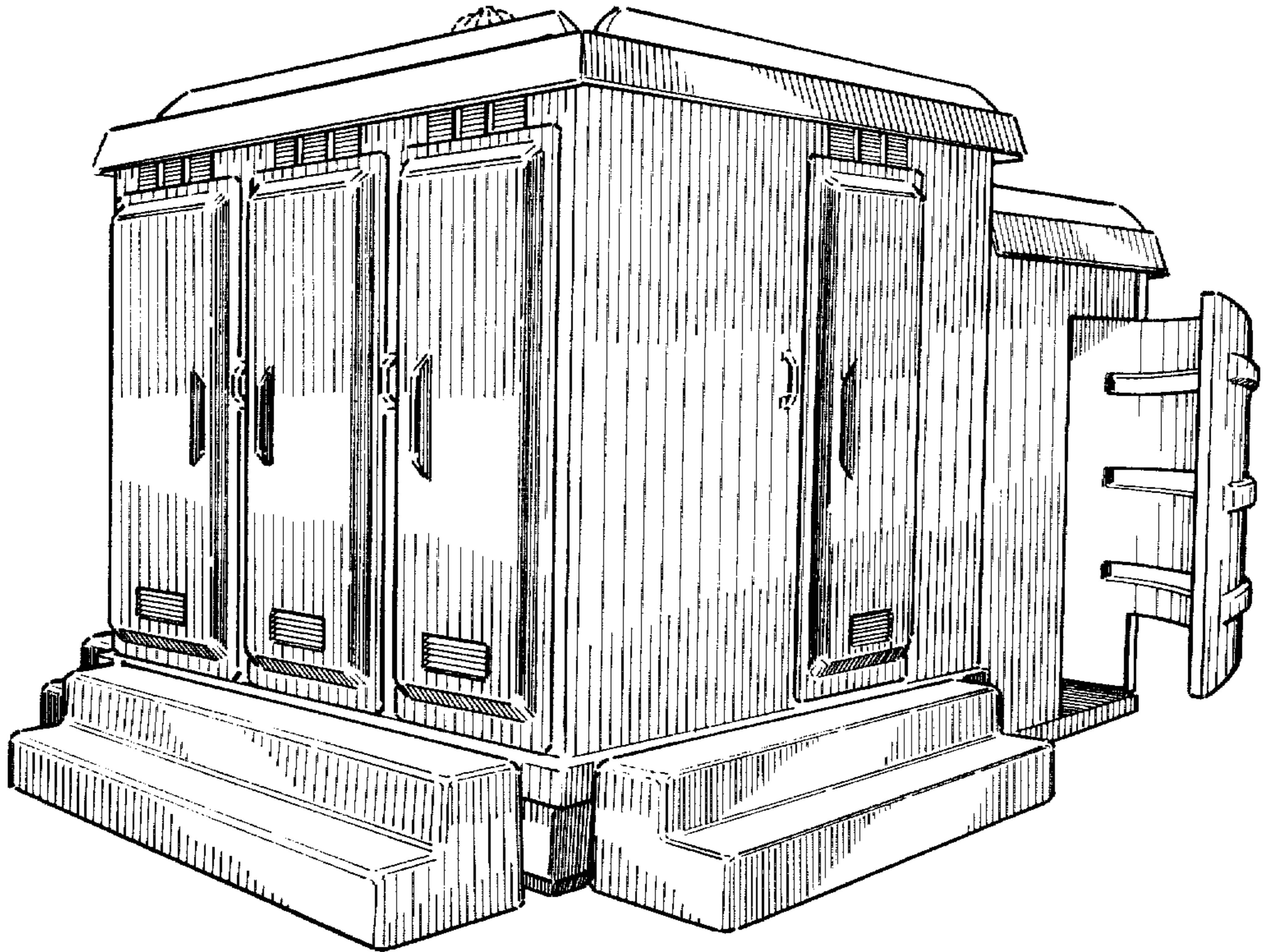

FIG 2

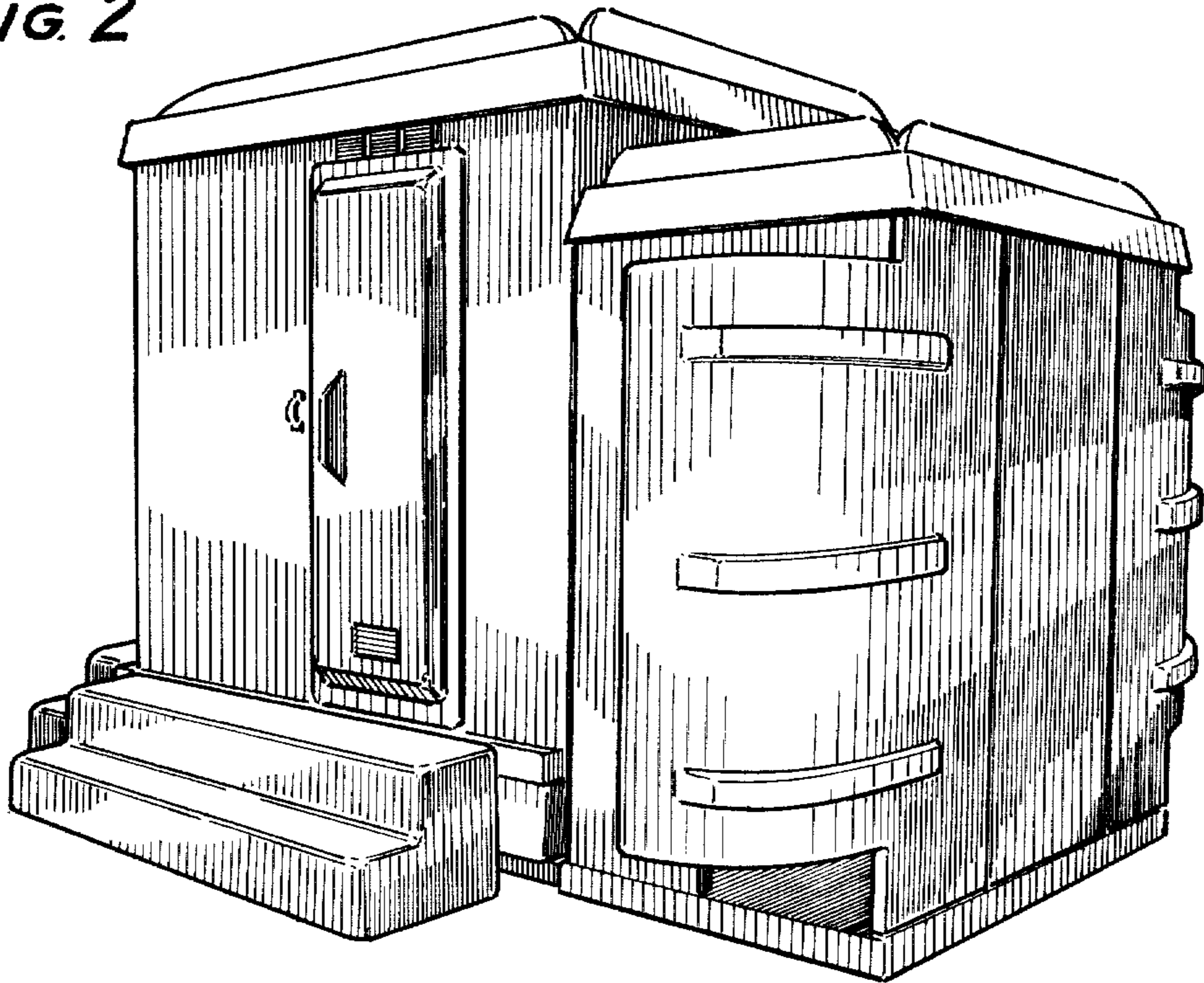

FIG. 3

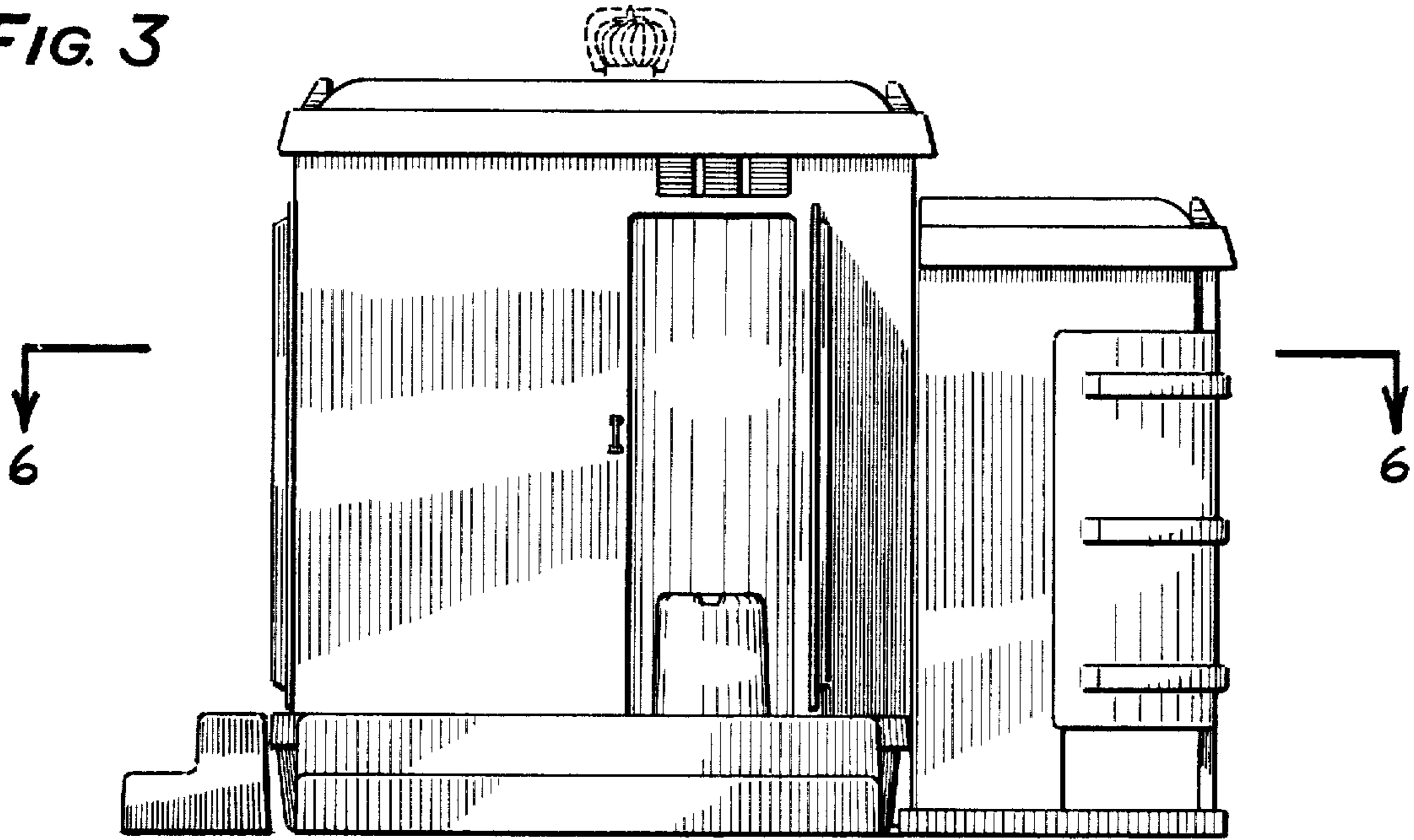

FIG. 4

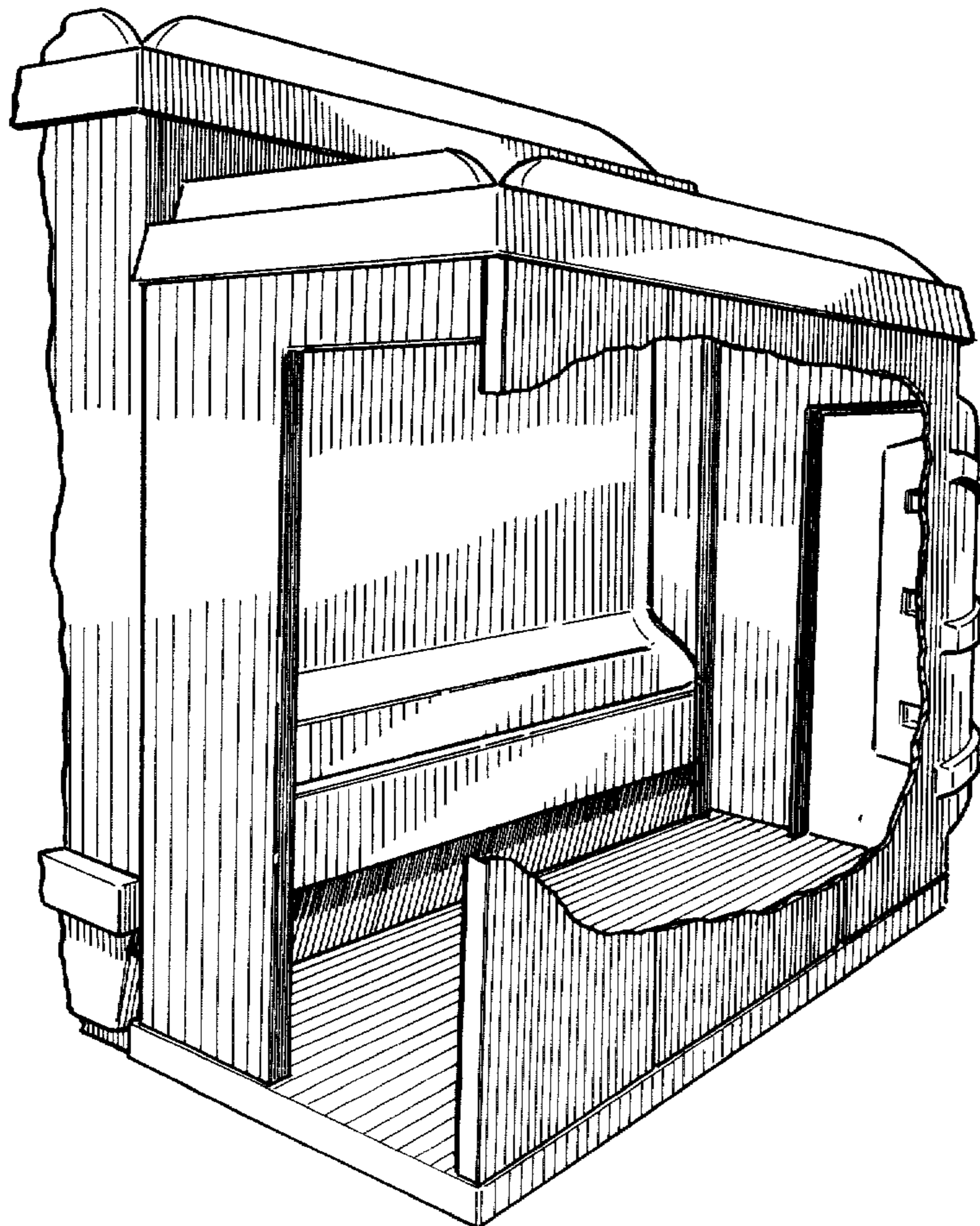

FIG. 5

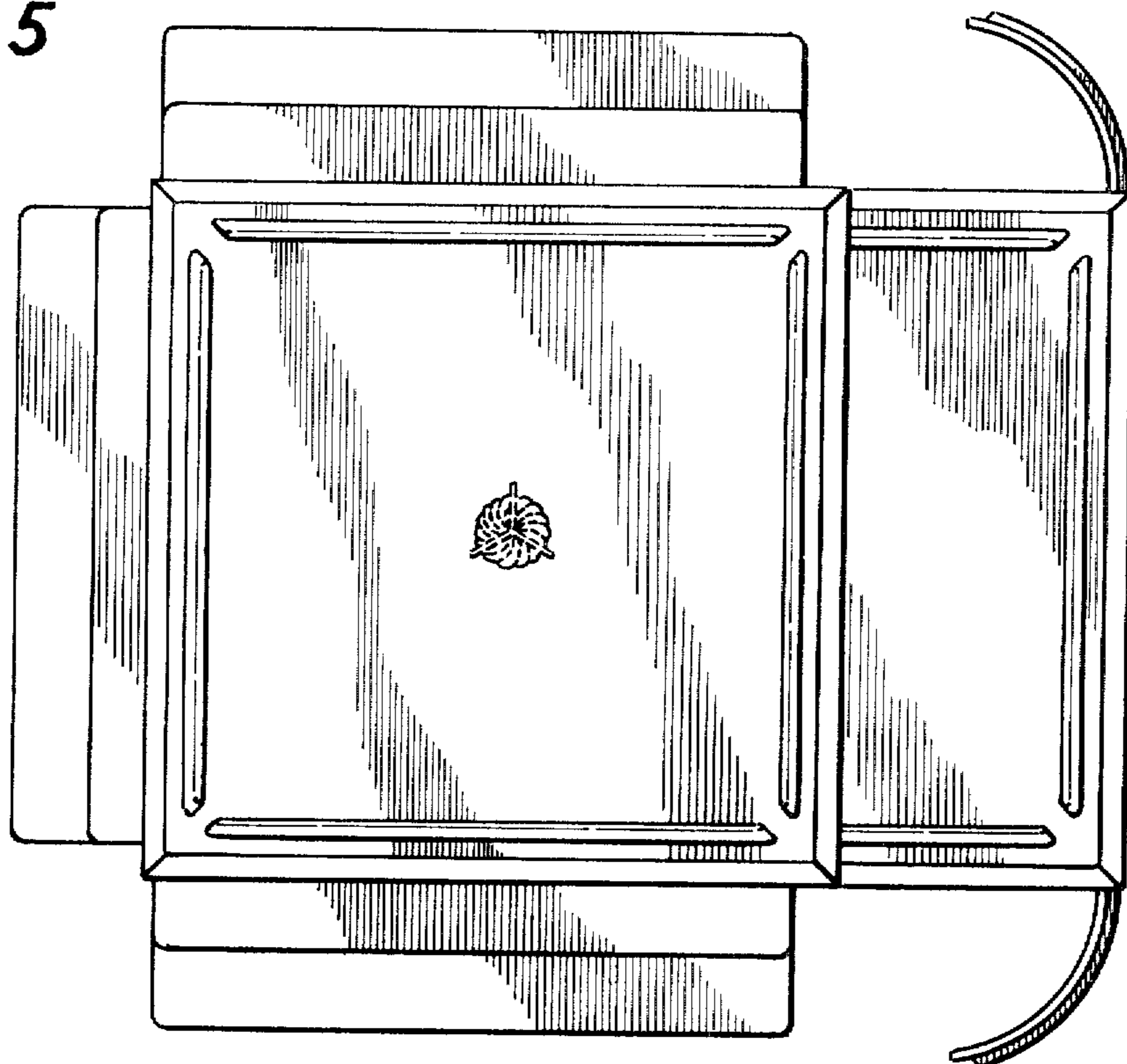

FIG. 6

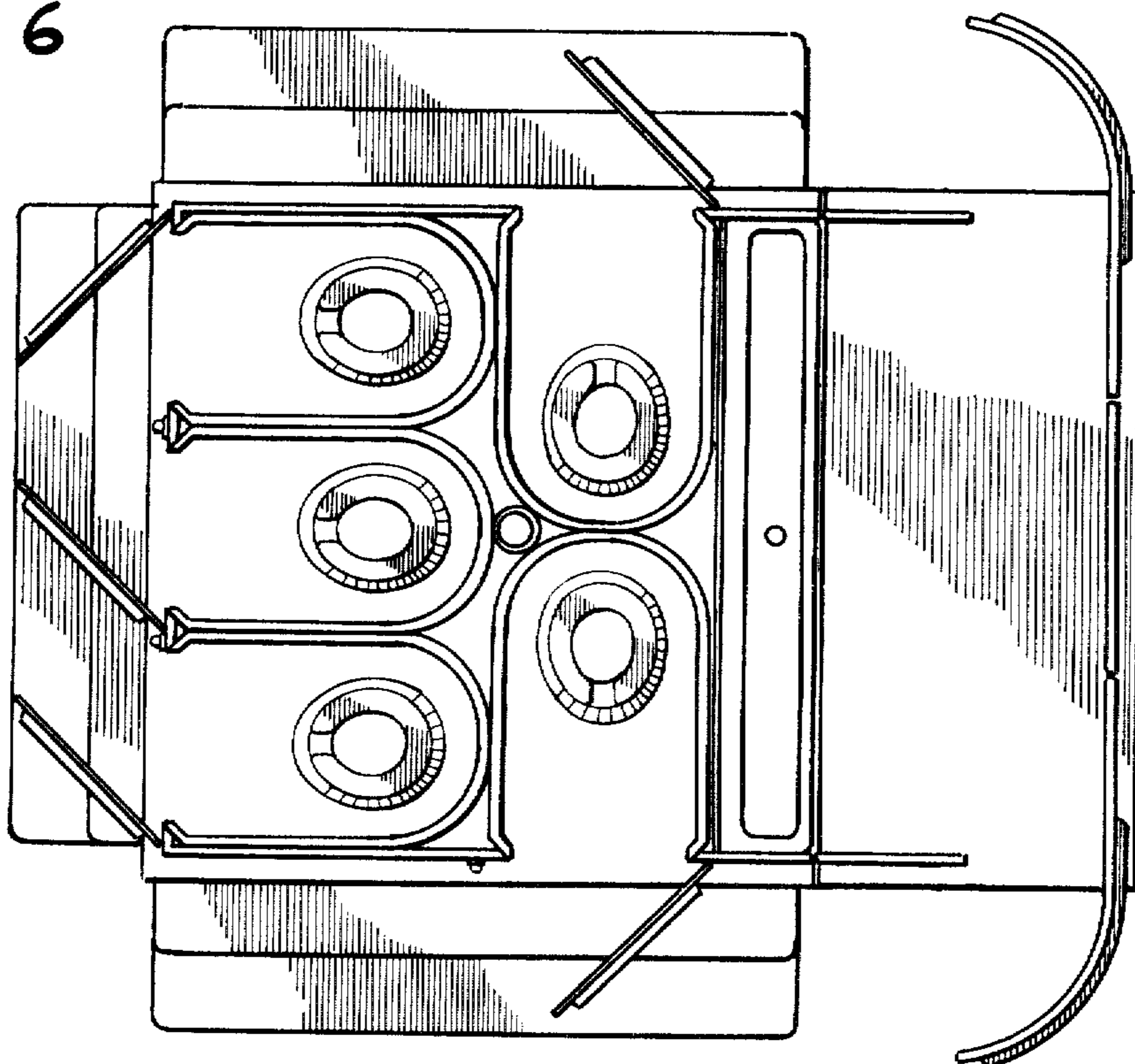

FIG. 7

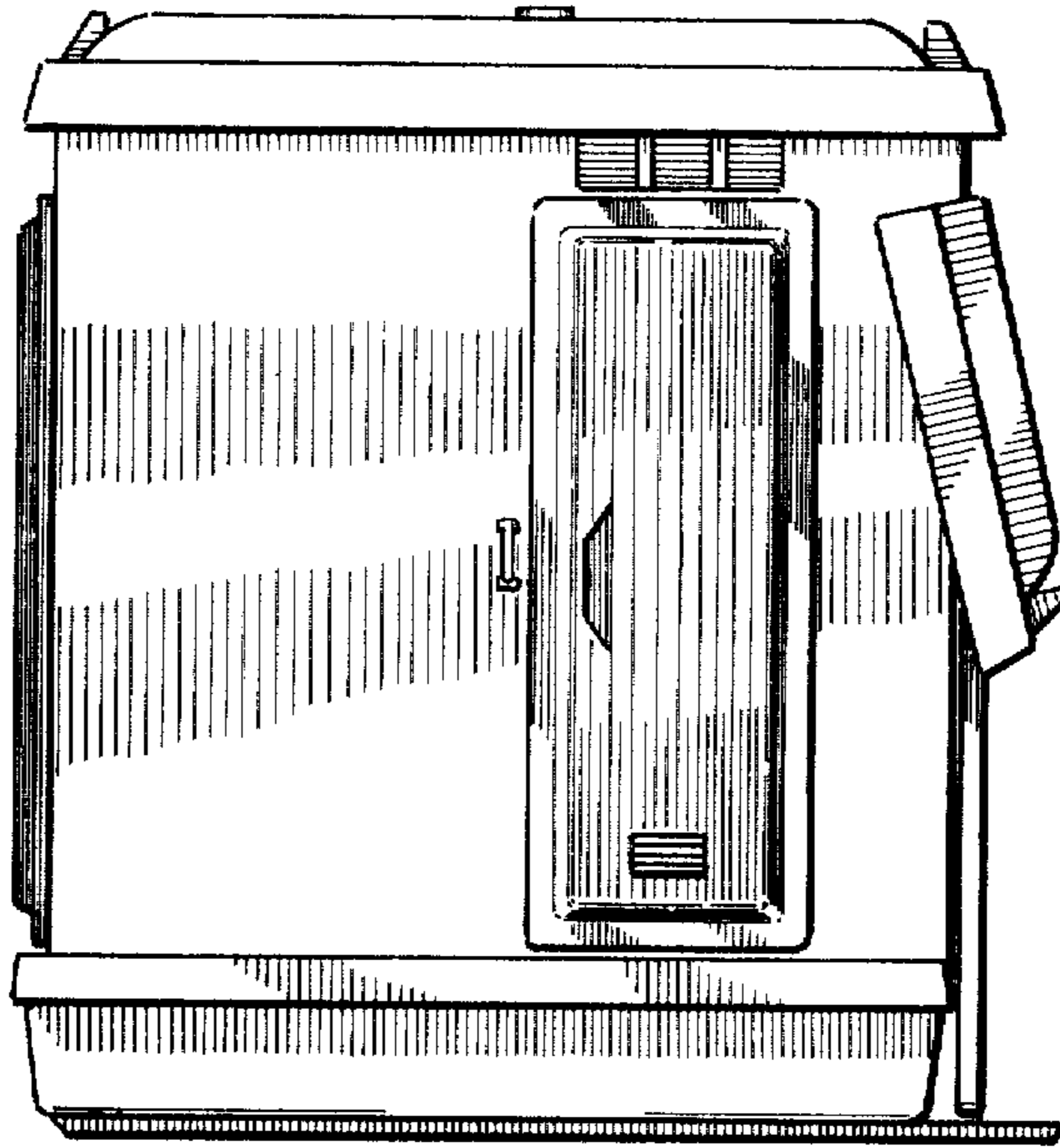

FIG. 8

