

[54] TOILET OR SIMILAR ARTICLE

[75] Inventor: **Henry M. Stairs, Jr.**, Neshanic, N.J.

[73] Assignee: **American Standard Inc.**, New York, N.Y.

[**] Term: **14 Years**

[21] Appl. No.: **62,860**

[22] Filed: **Jul. 31, 1979**

[51] Int. Cl. **D23-02**

[52] U.S. Cl. **D23/65**

[58] Field of Search **D23/48, 65-67;**
4/249, 258, 300, 317, 321, 323, 329, 330, 420

D. 191,697 11/1961 Chapman D23/65

D. 199,021 9/1964 Stairs, Jr. D23/65

D. 199,235 9/1964 Tiller D23/65

D. 217,551 5/1970 Manning D23/67

D. 237,884 12/1975 Korol D23/65

D. 250,202 11/1978 Doman et al. D23/65

4,162,548 7/1979 Goombridge 4/30

Primary Examiner—James R. Largen
Attorney, Agent, or Firm—James J. Salerno, Jr.; Robert G. Crooks; John P. Sinnott

[57] **CLAIM**

The ornamental design for a toilet or similar article, substantially as shown and described.

DESCRIPTION

FIG. 1 is a right side elevational view of a toilet or similar article embodying my new design, the left side being a mirror image of the right side shown;

FIG. 2 is a front elevational view thereof;

FIG. 3 is a top plan view thereof;

FIG. 4 is a rear elevational view thereof; and

FIG. 5 is a bottom plan view thereof.

[56] **References Cited**

U.S. PATENT DOCUMENTS

D. 101,535 10/1936 Kangtadt D23/65

D. 185,618 6/1959 Teague et al. D23/65

D. 188,750 9/1960 Swann D23/65

D. 191,160 8/1961 Chapman D23/65

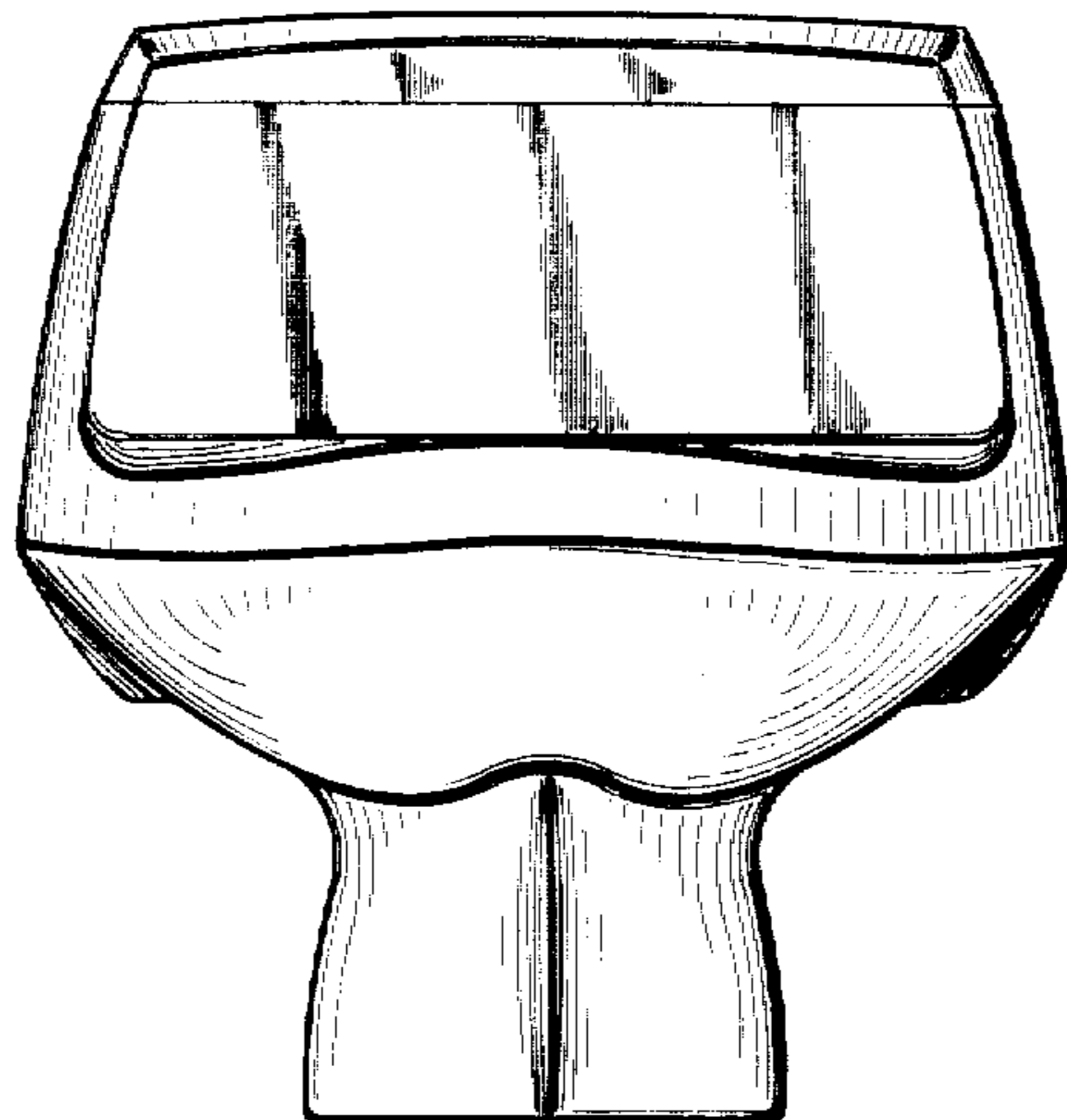
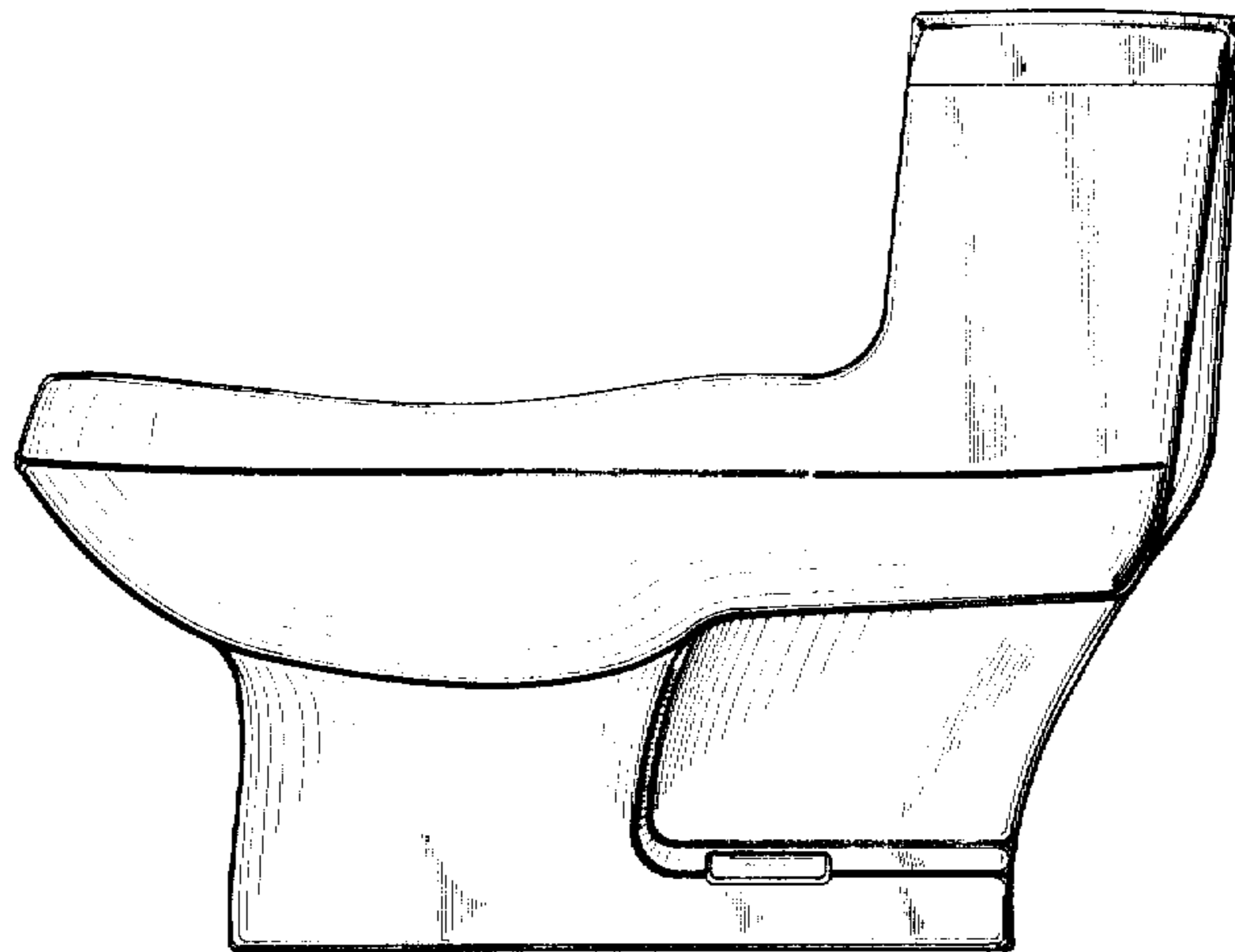

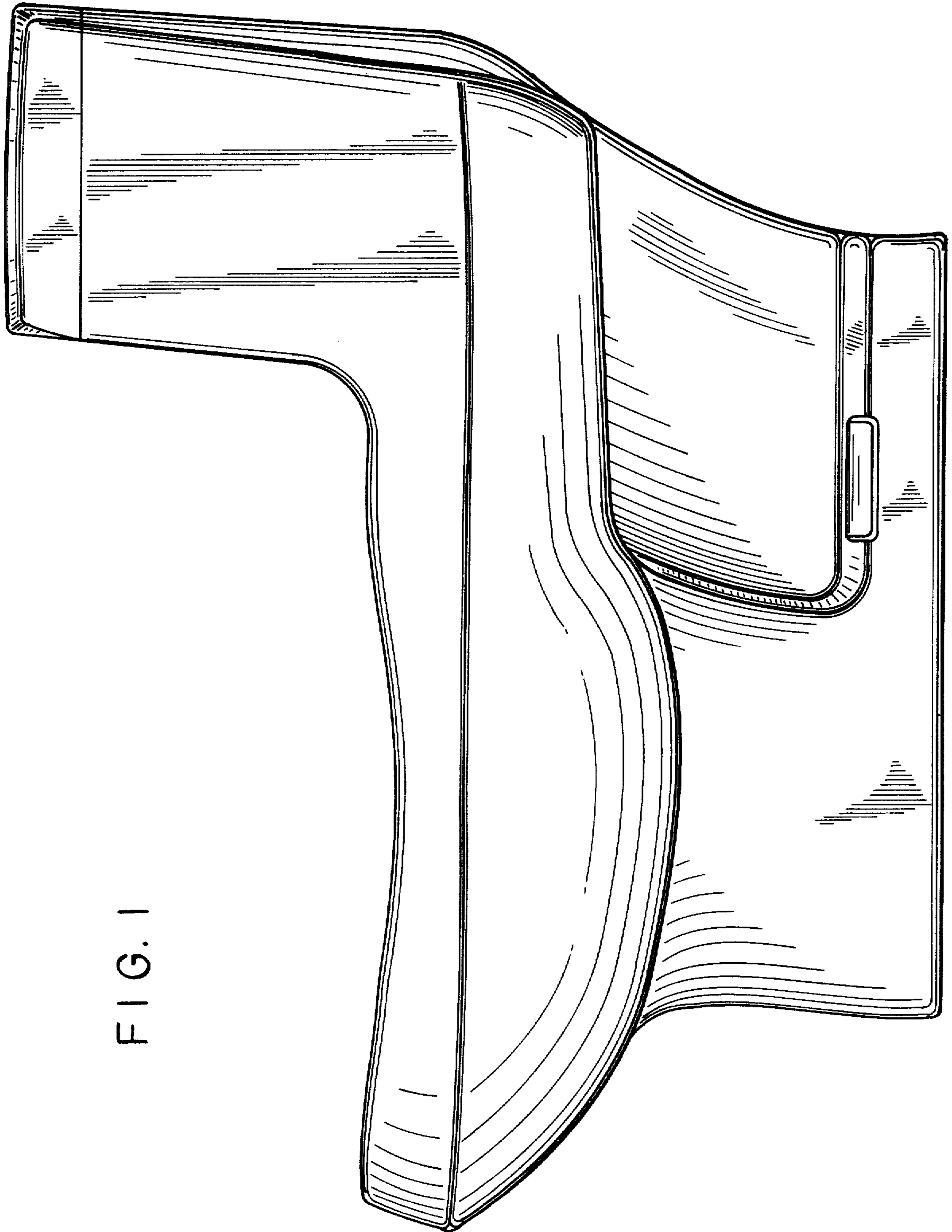
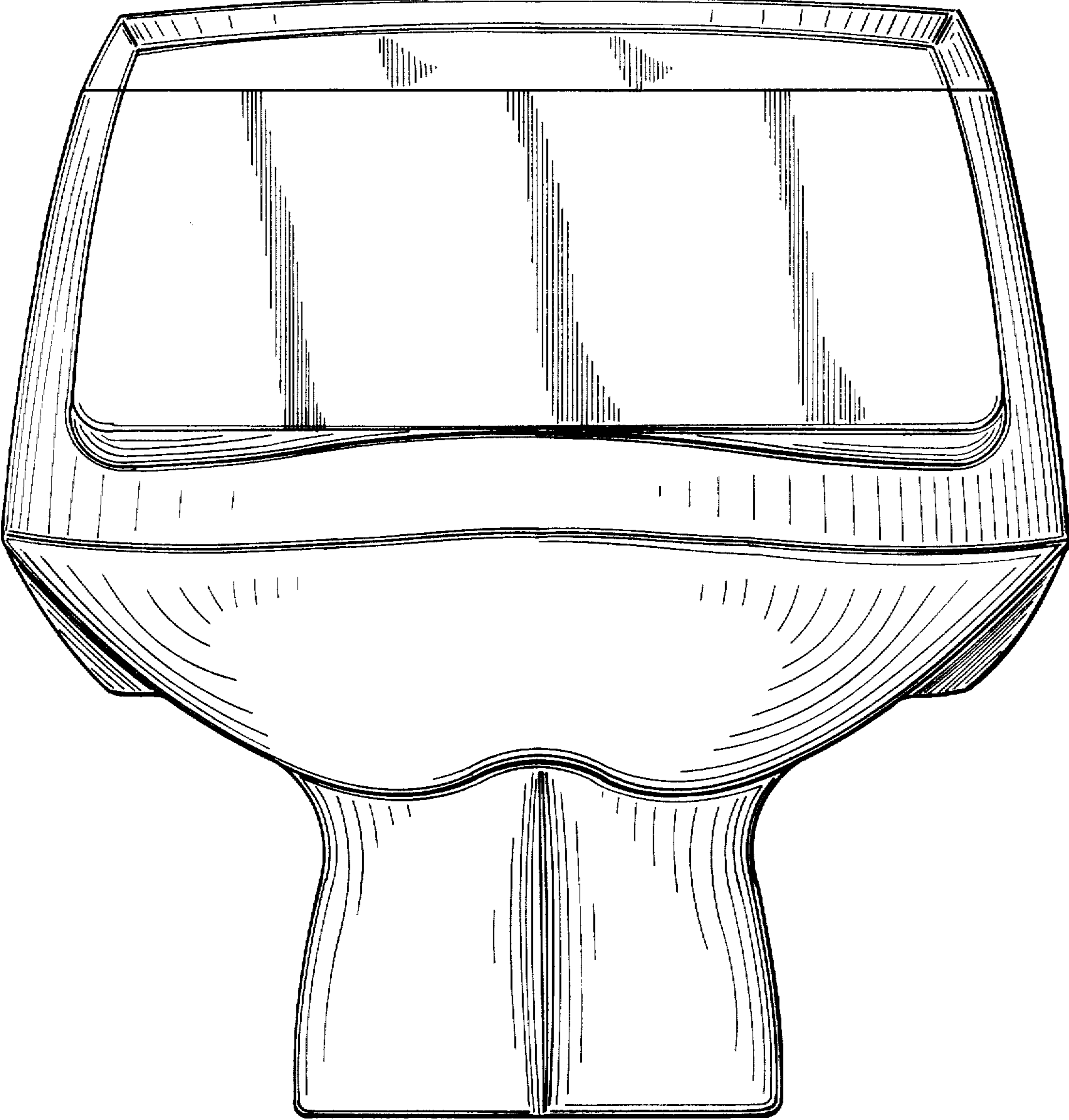

FIG. 1

FIG. 2



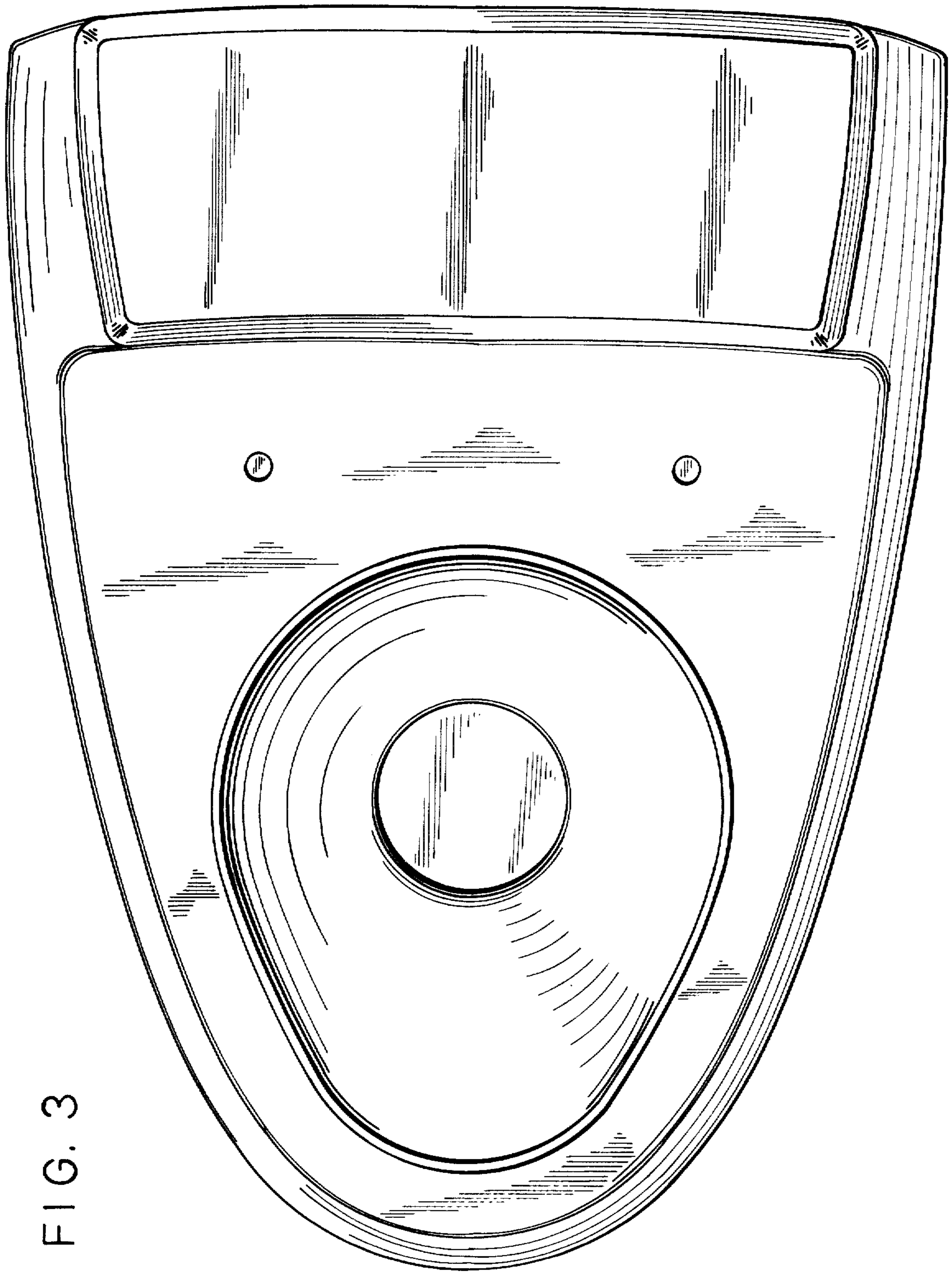
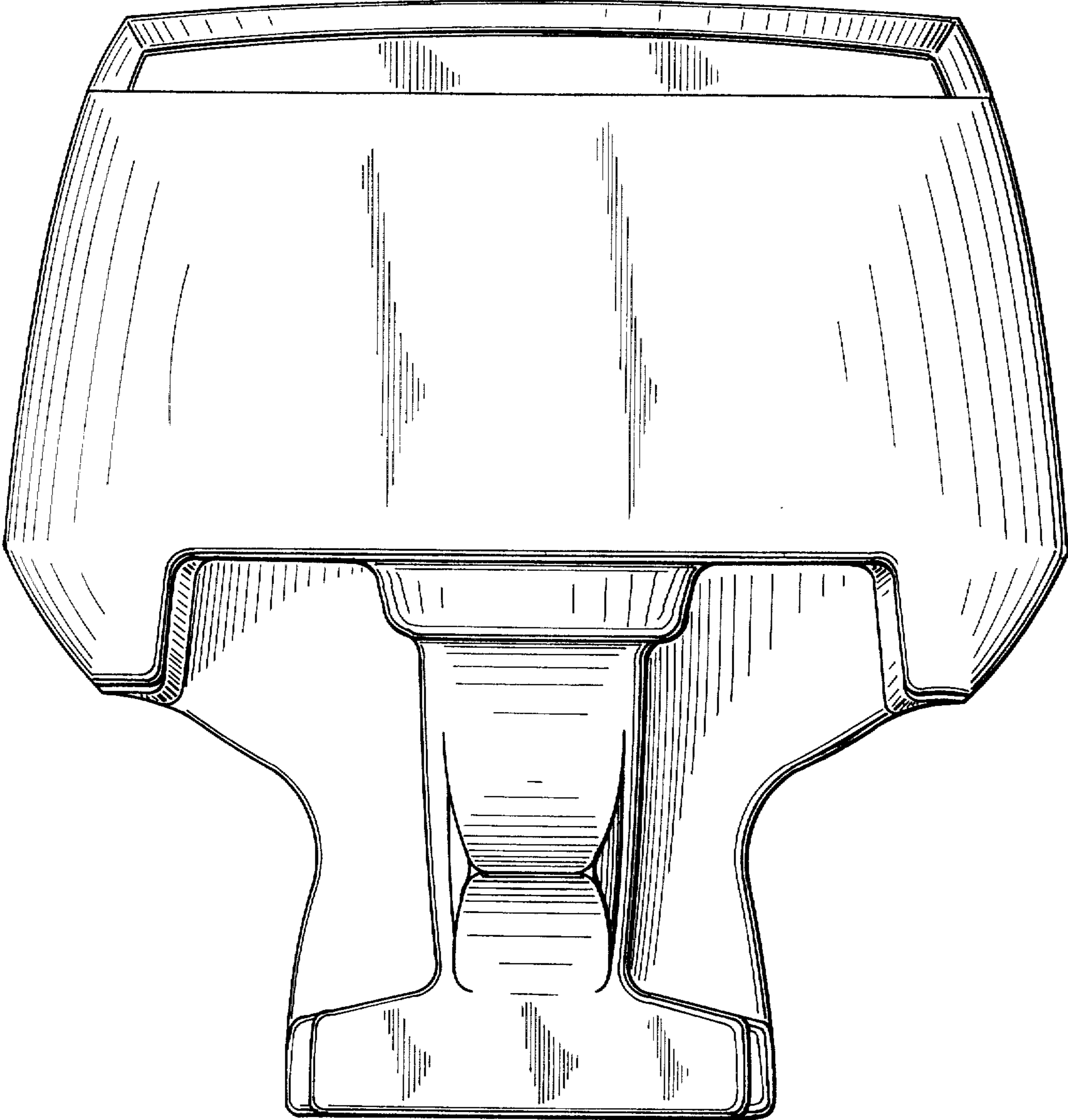

FIG. 3

FIG. 4



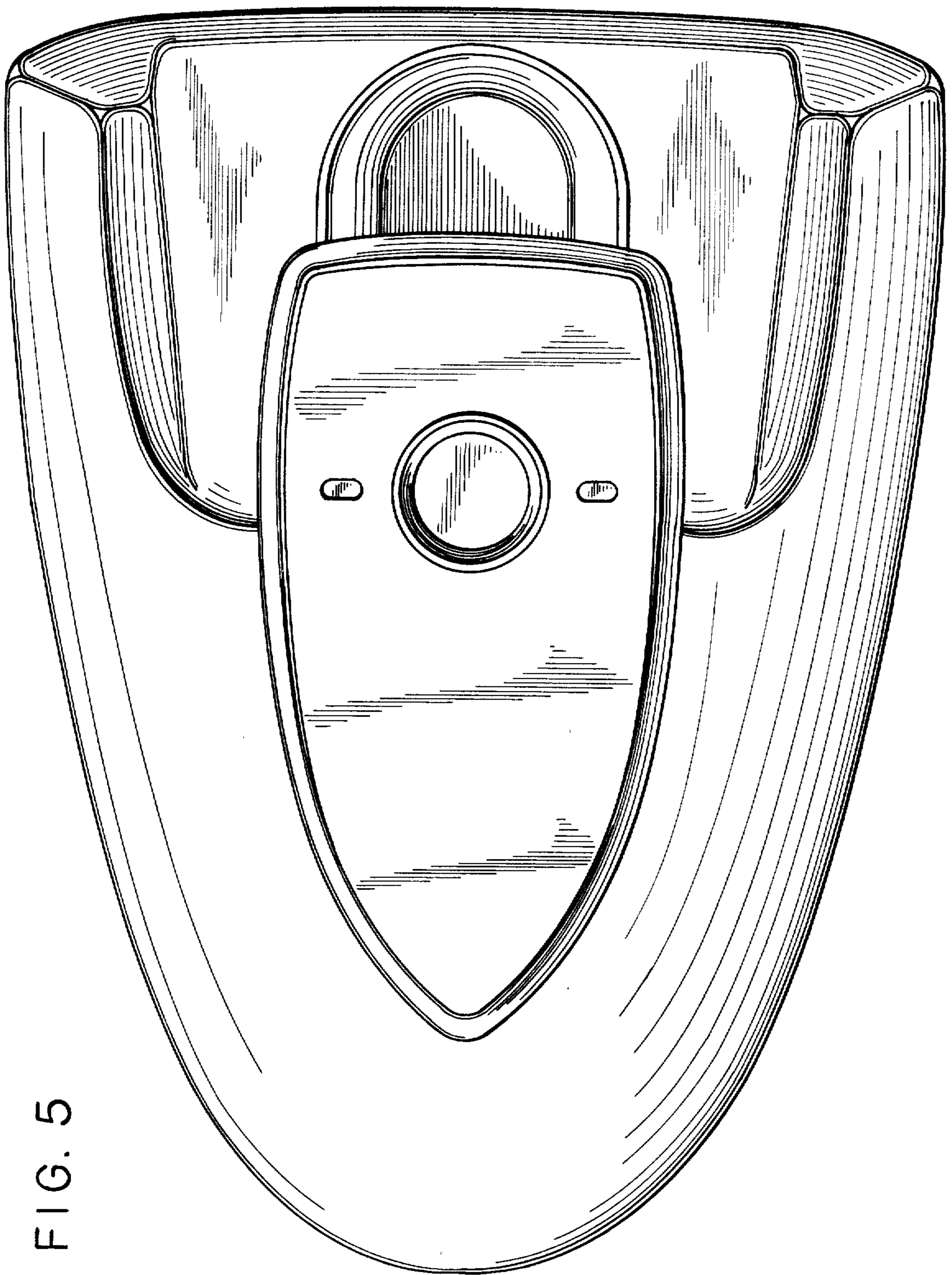

FIG. 5