

[54] RECTANGULAR CURVED SLIDE SPA

[76] Inventor: John L. Haller, 7249 Carrizo Dr., La Jolla, Calif. 92037

[**] Term: 14 Years

[21] Appl. No.: 966,908

[22] Filed: Dec. 6, 1978

[51] Int. Cl. D24-01; D23-02

[52] U.S. Cl. D24/38; D23/55; D25/2

[58] Field of Search 128/66, 366, 367, 369; 4/193, 492, 488, 493; D24/38; D23/55, 56, 57; 25/2

[56] References Cited

U.S. PATENT DOCUMENTS

- D. 221,495 8/1971 Cavenah D24/38
- D. 240,084 5/1976 Melchior D23/55 X
- D. 245,542 8/1977 Melchior D25/2 X
- D. 250,962 1/1979 Bonsack D23/55
- D. 254,688 4/1980 Reineman D24/38
- 3,688,775 9/1972 Raymann 128/366

Primary Examiner—Bernard Ansher
Attorney, Agent, or Firm—John L. Haller

[57] CLAIM

The ornamental design for a rectangular curved slide spa, as shown and described.

DESCRIPTION

FIG. 1 is a perspective view of the rectangular curved slide spa, showing my new design;
 FIG. 2 is a top plan view of the rectangular curved slide spa;
 FIG. 3 is a sectional view of the rectangular curved slide spa taken at about 3—3 of FIG. 2;
 FIG. 4 is a sectional view of the rectangular curved slide spa taken at about 4—4 of FIG. 2;
 FIG. 5 is a sectional view of the rectangular curved slide spa taken at about 5—5 of FIG. 2;
 FIG. 6 is a sectional view of the rectangular curved slide spa taken at about 6—6 of FIG. 2;
 FIG. 7 is a sectional view of the rectangular curved slide spa taken at about 7—7 of FIG. 2;
 FIG. 8 is a sectional view of the rectangular curved slide spa taken at about 8—8 of FIG. 2;
 FIG. 9 is a sectional view of the rectangular curved slide spa taken at about 9—9 of FIG. 2;
 FIG. 10 is a sectional view of the rectangular curved slide spa taken at about 10—10 of FIG. 2;
 FIG. 11 is a perspective view of an alternative embodiment of the rectangular curved slide spa; and
 FIG. 12 is a top plan view of the alternate embodiment shown in FIG. 11.

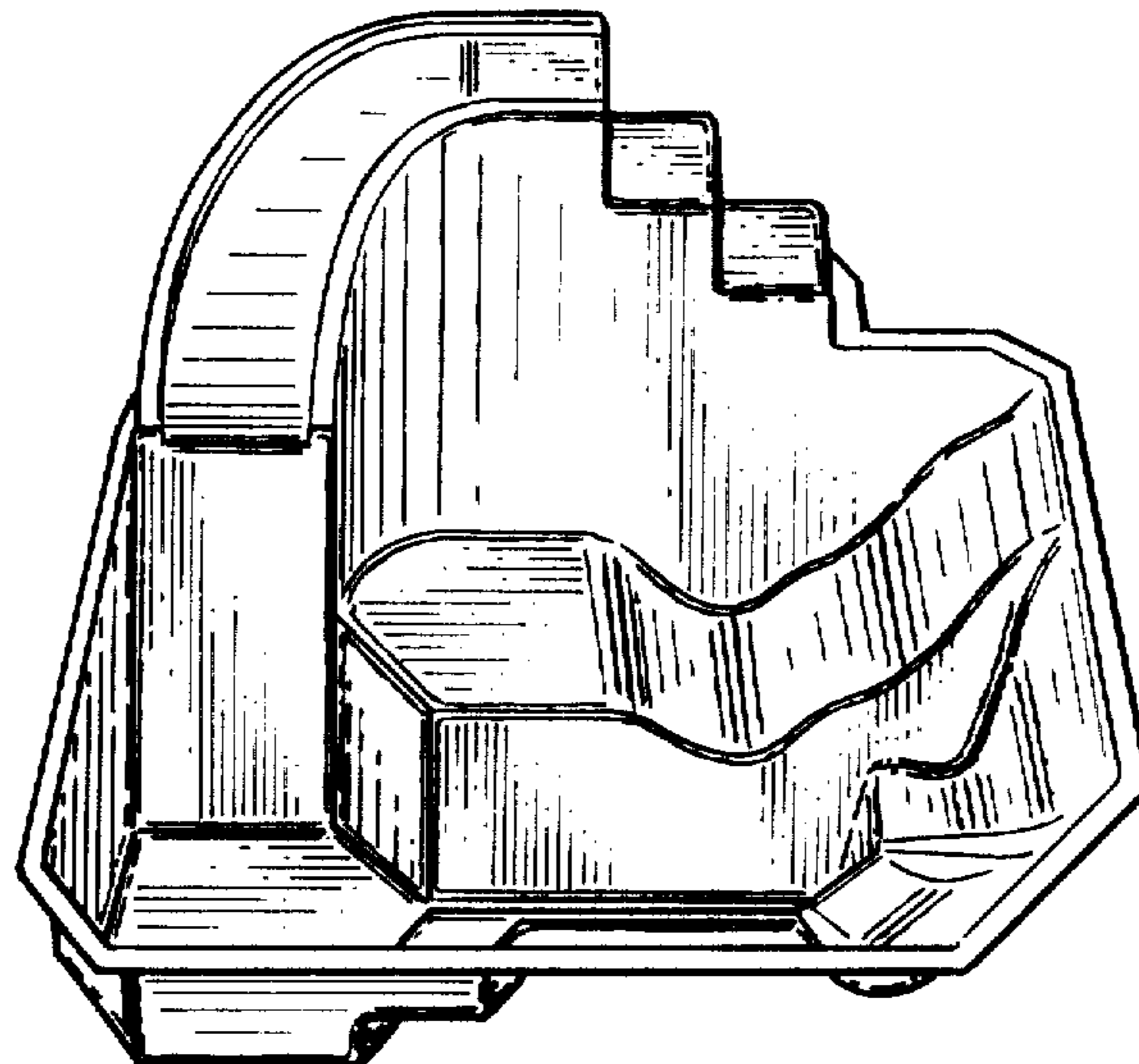

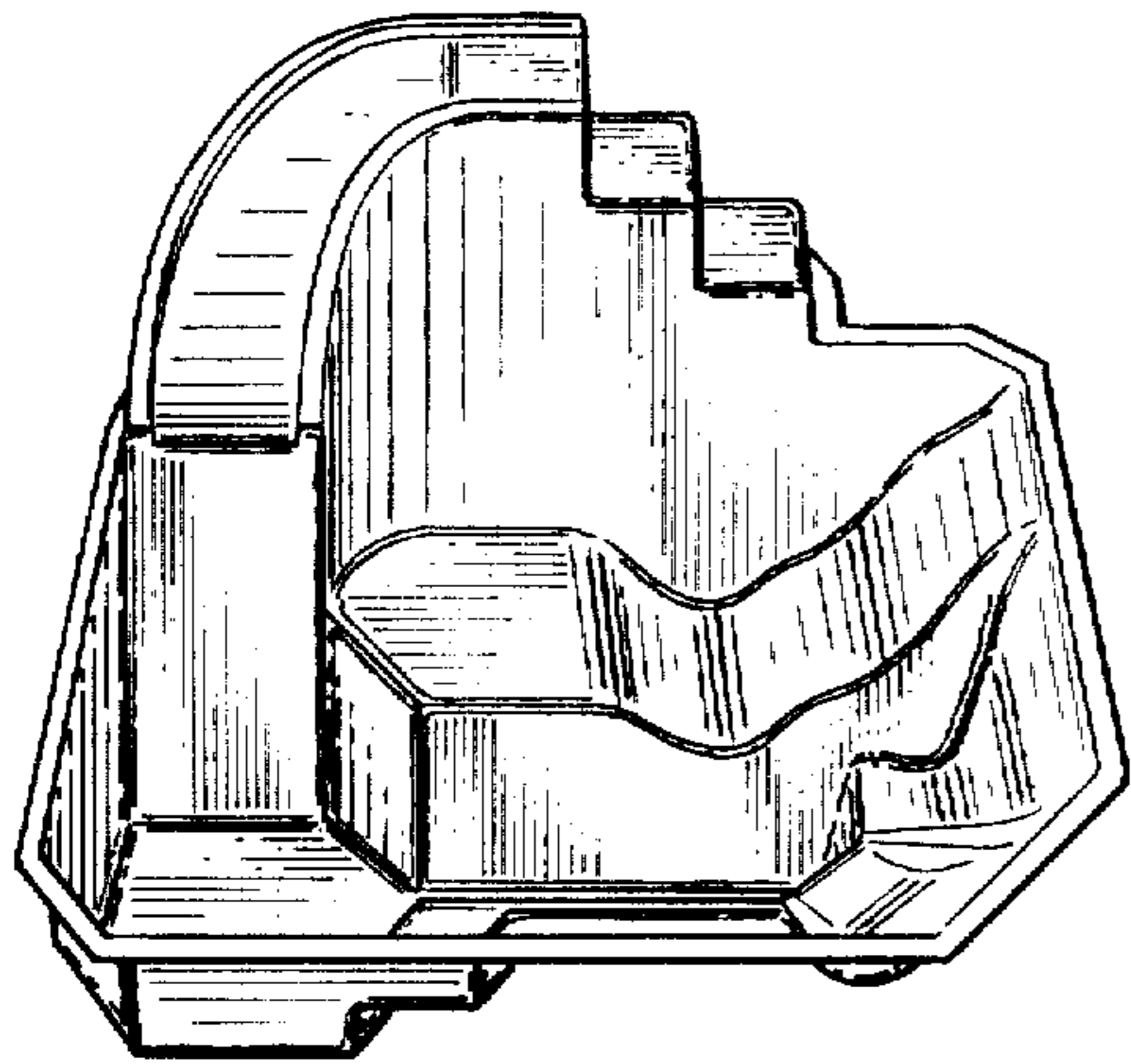

FIG. 1

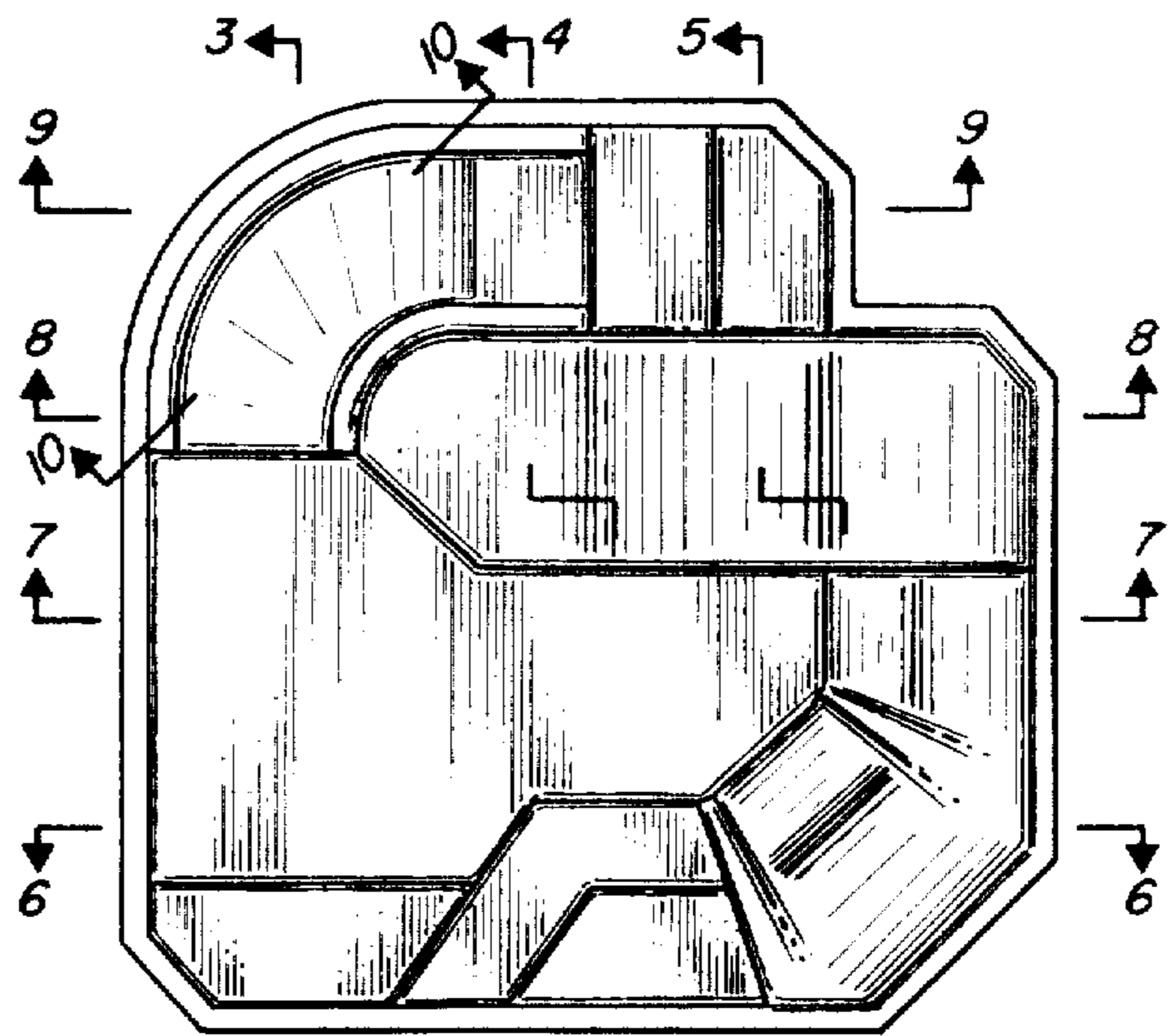

FIG. 2

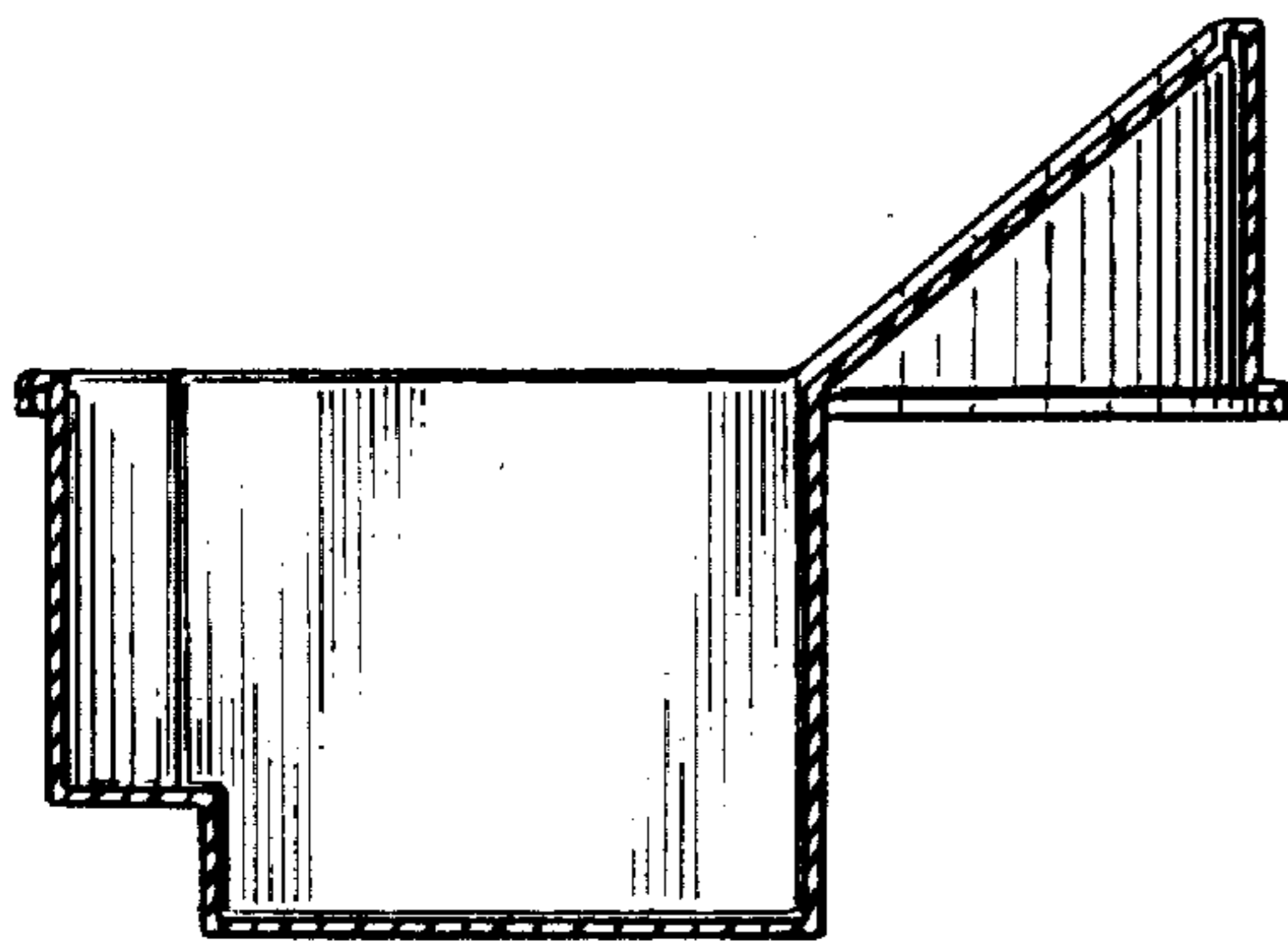

FIG. 3

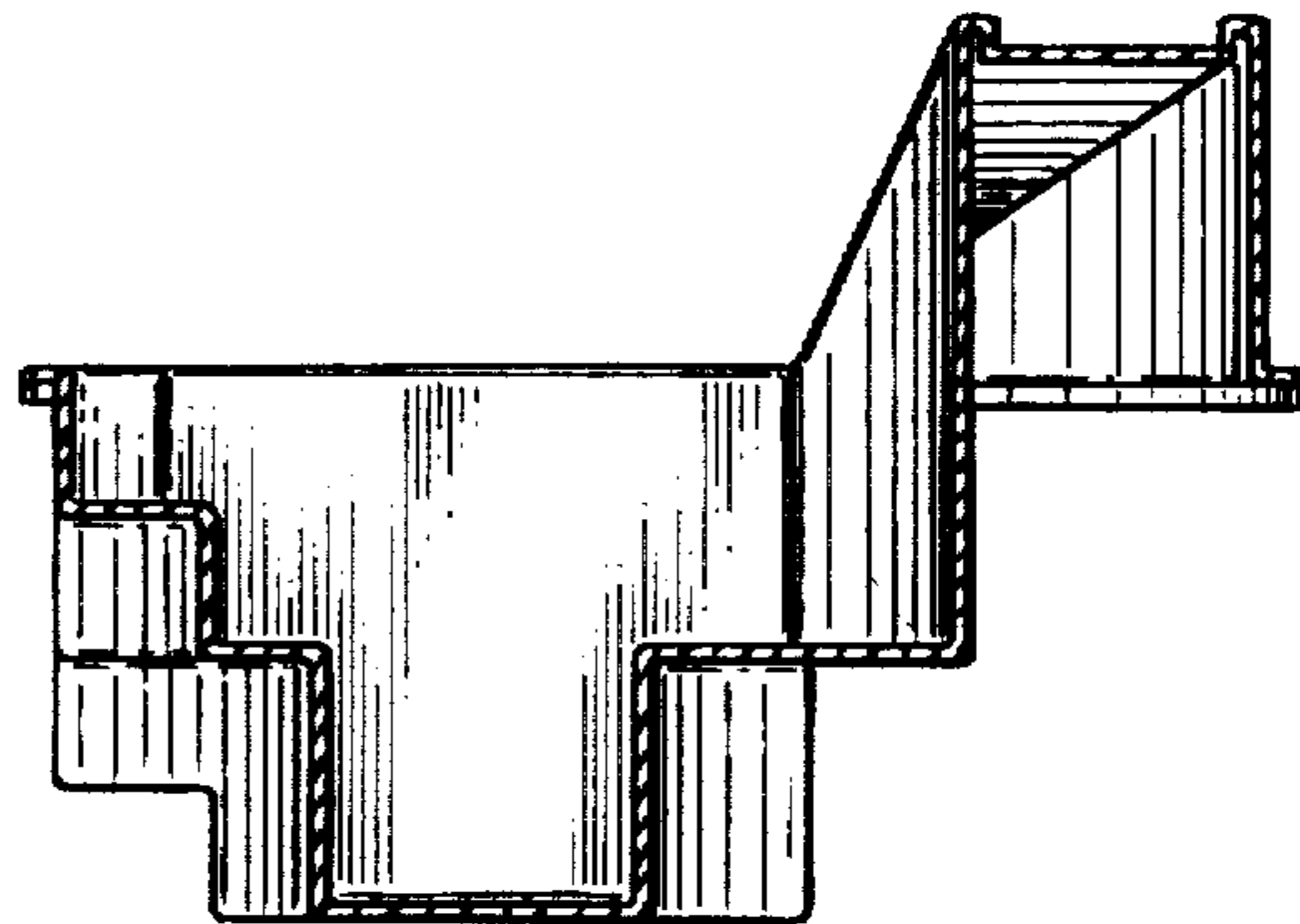

FIG. 4

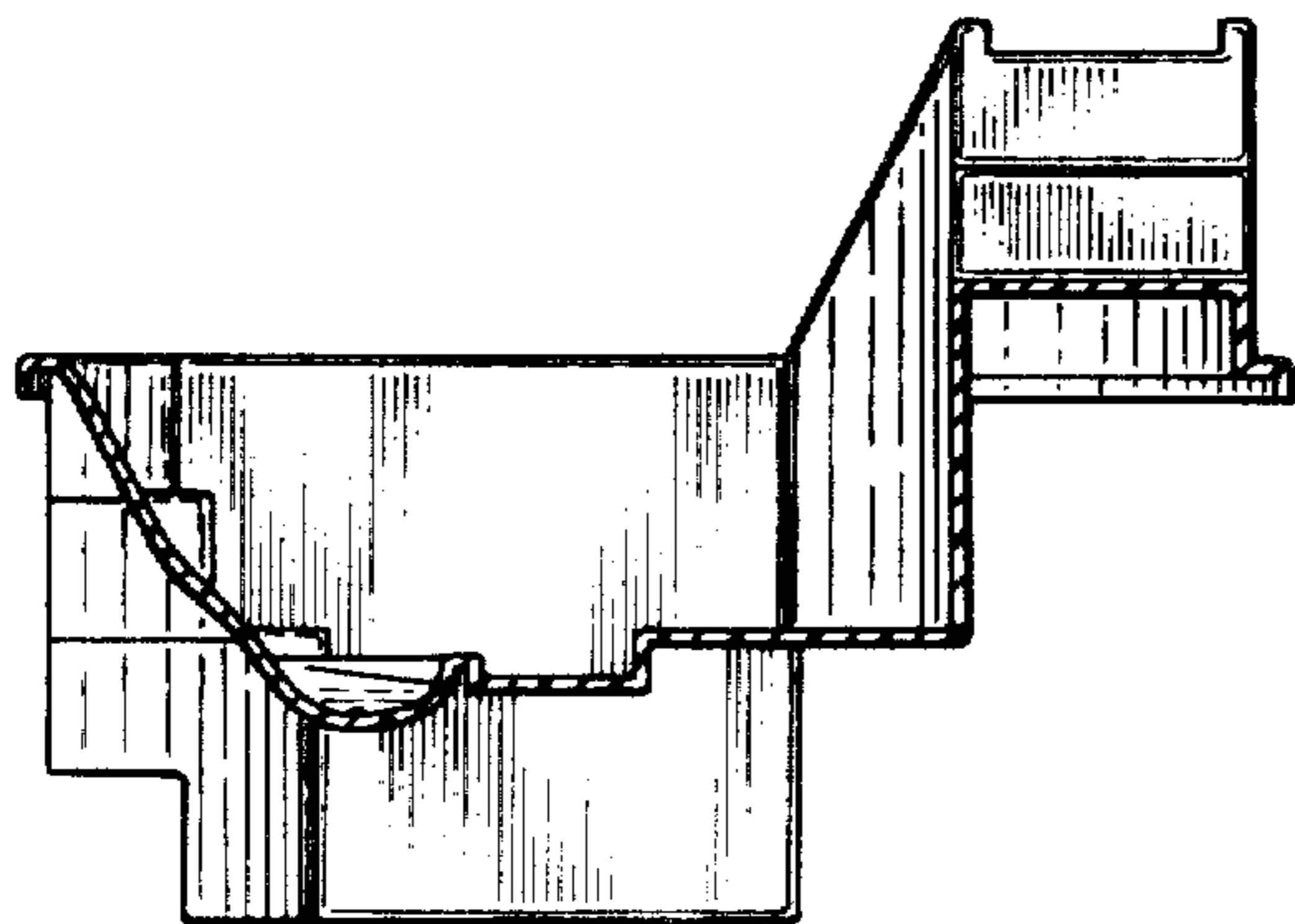

FIG. 5

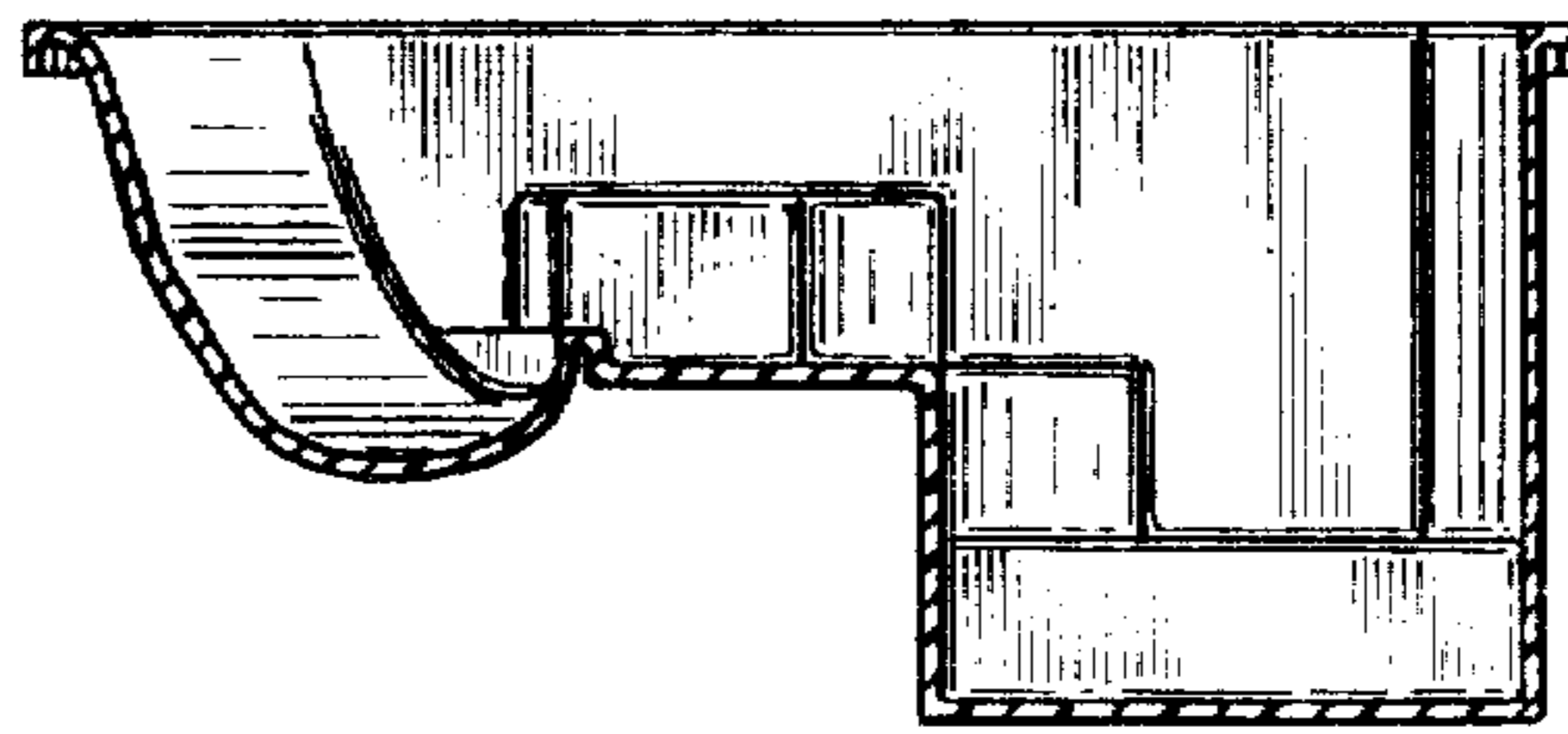

FIG. 6

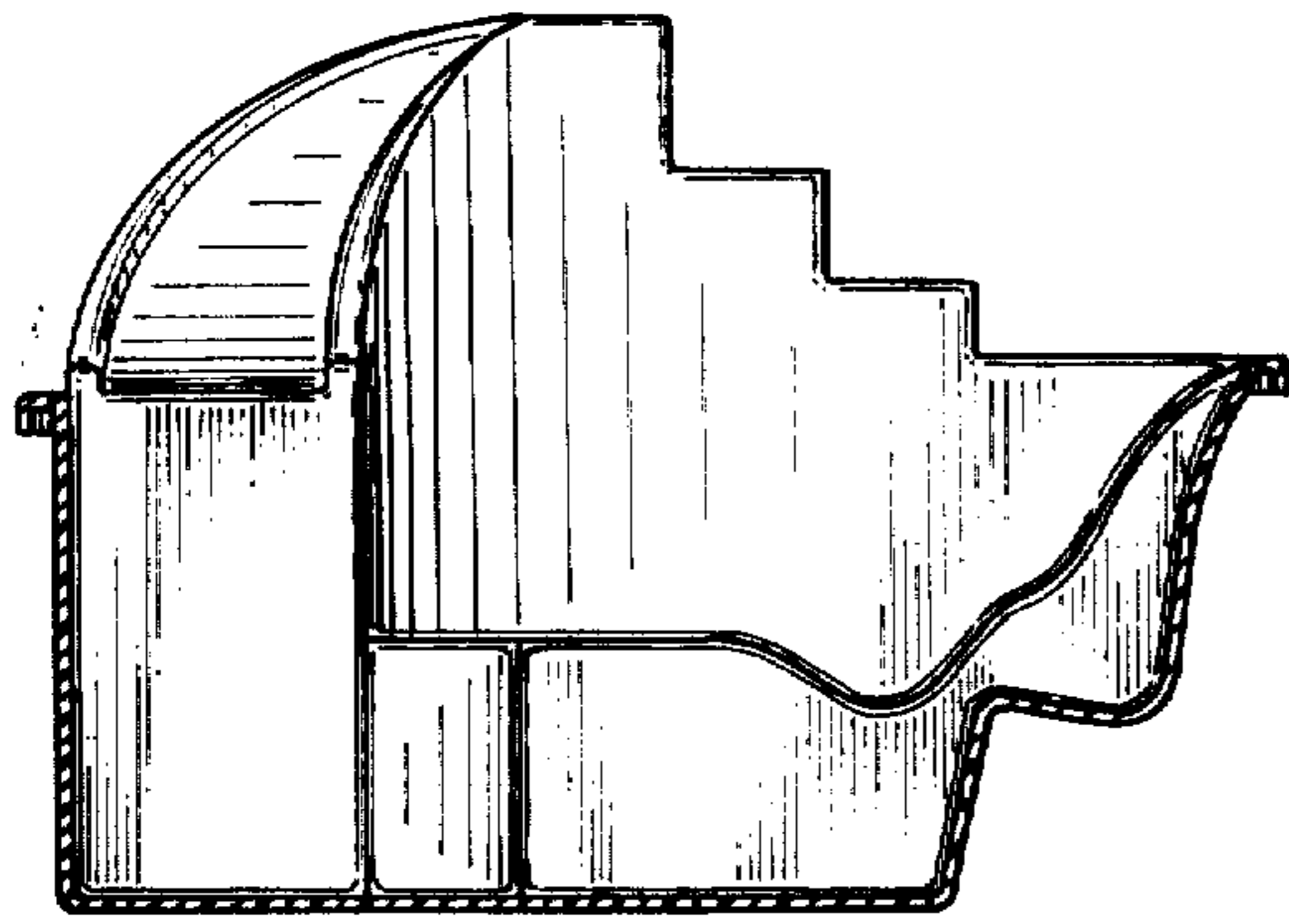

FIG. 7

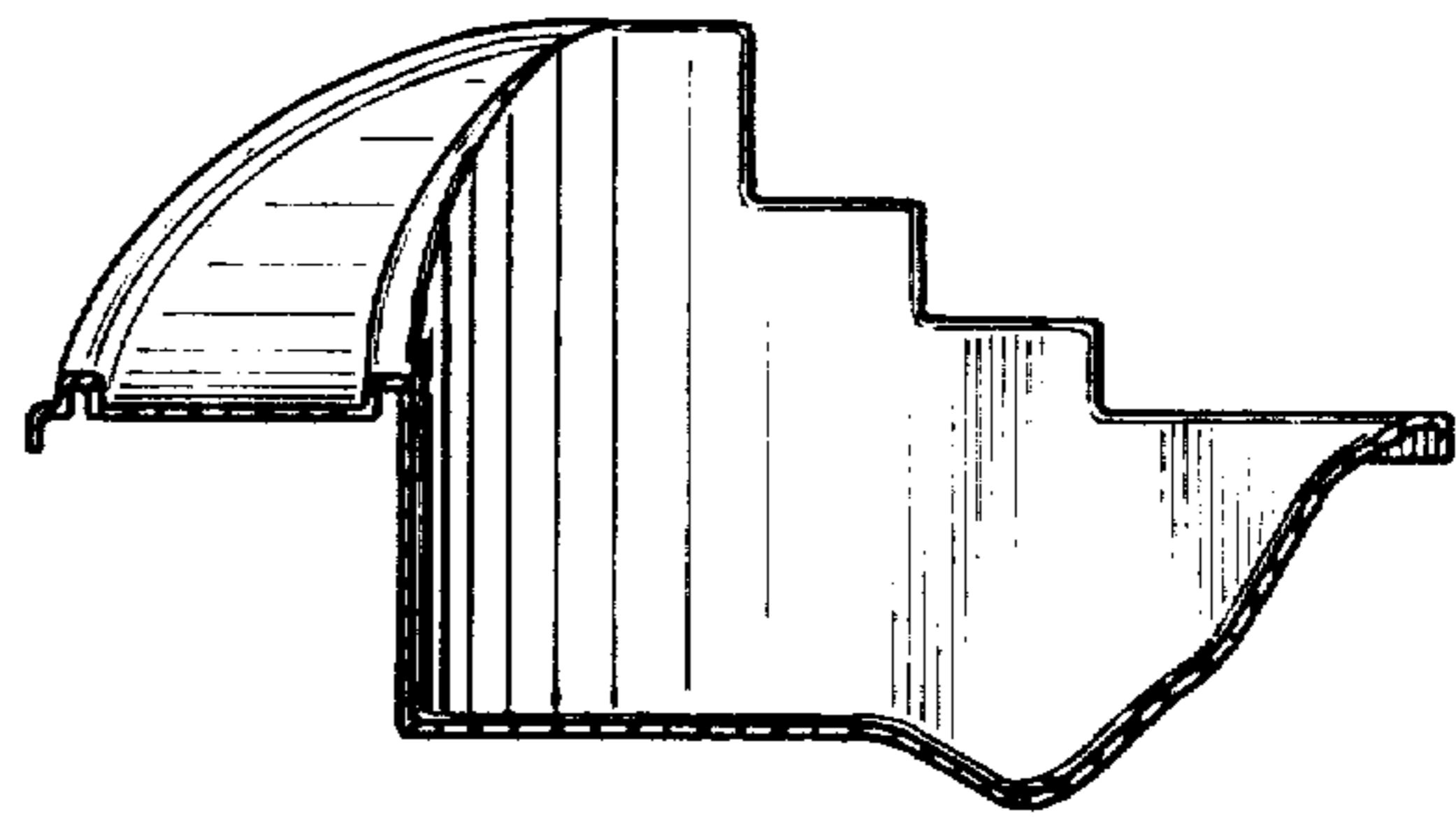

FIG. 8

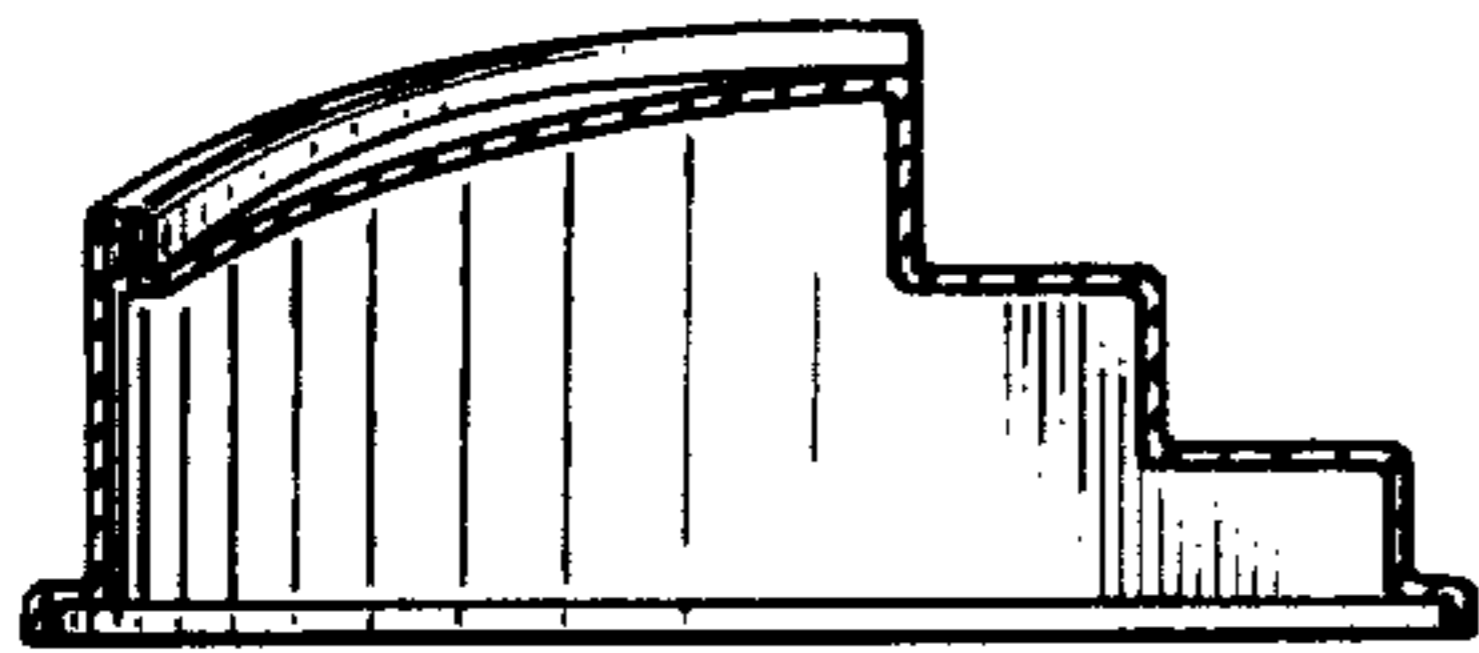

FIG. 9

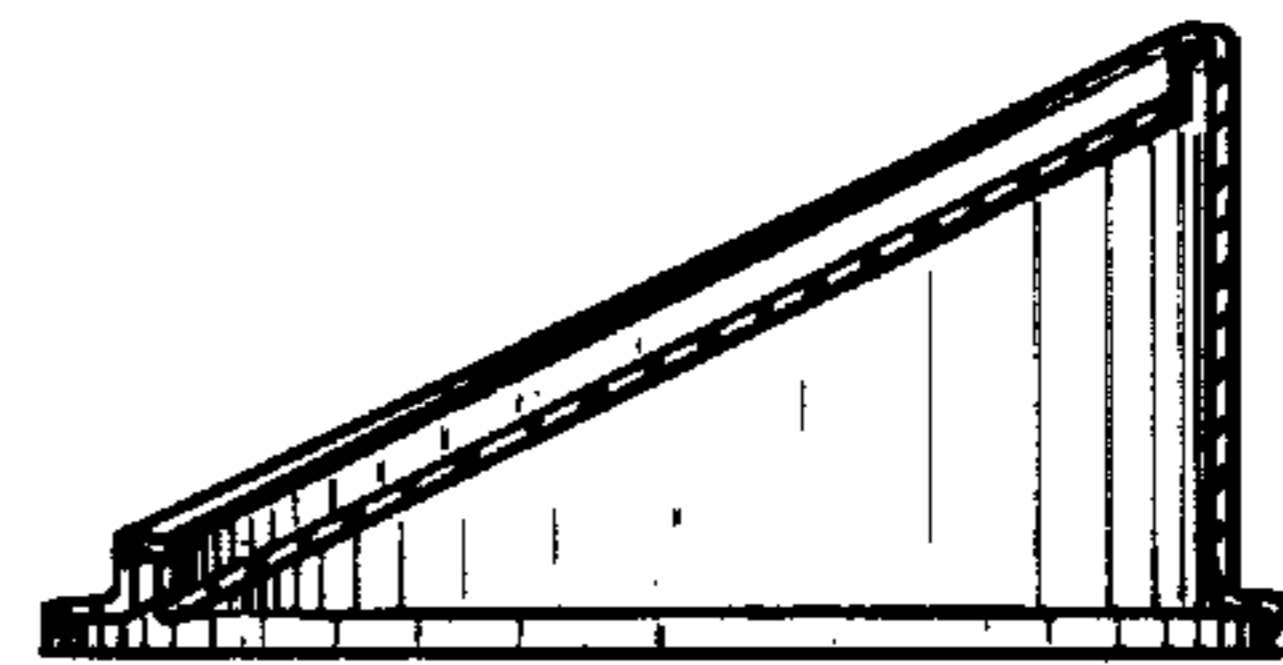

FIG. 10

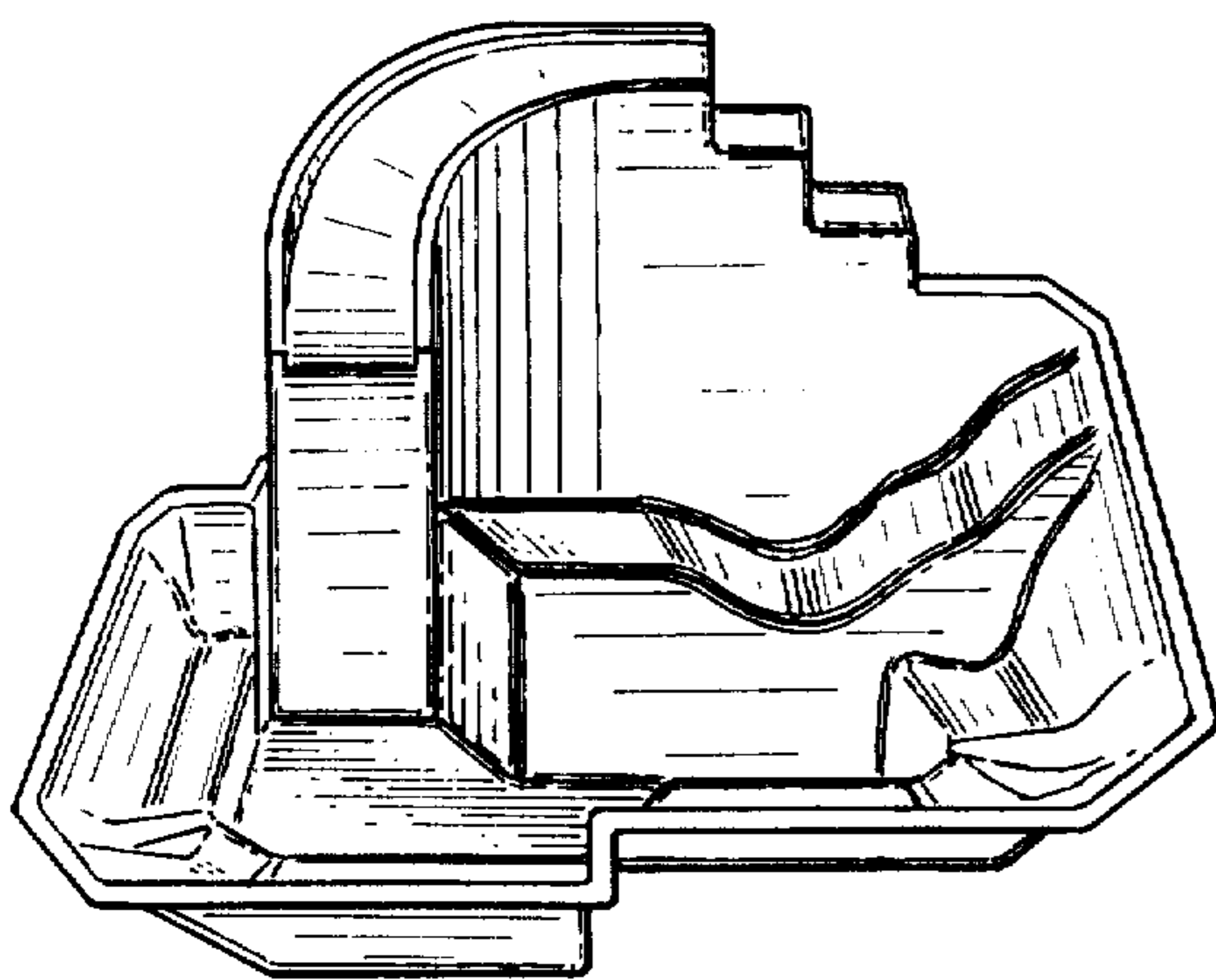

FIG. 11

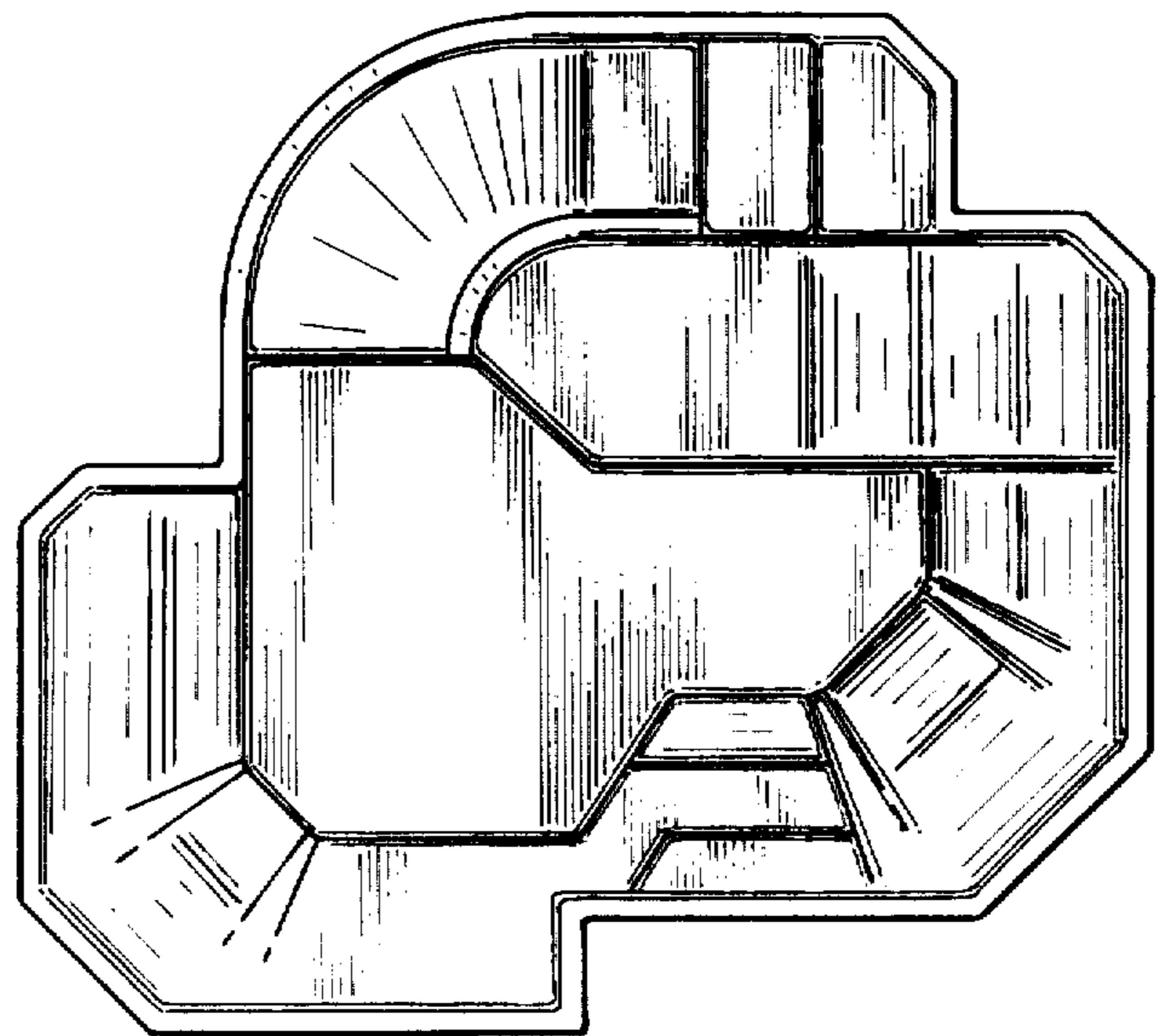

FIG. 12