

[54] COTTAGE CHEESE MAKING APPLIANCE

[75] Inventor: Pierre Ansel, Vagney, France

[73] Assignee: SEB, Selongey, France

[**] Term: 14 Years

[21] Appl. No.: 959,194

[22] Filed: Nov. 7, 1978

[30] Foreign Application Priority Data

May 16, 1978 [FR] France 150

[51] Int. Cl. D07-04

[52] U.S. Cl. D7/96; D7/41

[58] Field of Search D7/41, 85, 96, 129, D7/76, 79, 17, 3; D15/92, 104, 121

[56] References Cited

U.S. PATENT DOCUMENTS

- D. 105,718 8/1937 Stern D7/96
- D. 218,256 8/1970 Rams D15/100
- D. 231,968 7/1974 Juhlin D7/17
- D. 232,997 10/1974 Koblick D7/41
- 3,769,899 11/1973 Kostko D7/85 X

FOREIGN PATENT DOCUMENTS

477381 10/1915 France D7/61

OTHER PUBLICATIONS

Woodward & Lothrop Noel 1978 Cat., p. 88, Item #88J, "Yogurt Maker"-bottom r. panel. Housewares, Jun. 7-13, 1978, p. 16, Electrics top row, "Yogourmet", at top left.

Primary Examiner—Winifred E. Herrmann
Attorney, Agent, or Firm—Young & Thompson

[57] CLAIM

The ornamental design for a cottage cheese making appliance, as shown and described.

DESCRIPTION

FIG. 1 is an elevational view of a cottage cheese making appliance showing my new design;
 FIG. 2 is an elevational view from the side opposite FIG. 1;
 FIG. 3 is a top plan view thereof;
 FIG. 4 is a bottom plan view thereof;
 FIG. 5 is a top perspective view thereof;
 FIG. 6 is an exploded top perspective view thereof showing the outer vessel, the two inner vessels fitting in one another, and the cover.
 FIG. 7 is an exploded side elevational view showing all components separately.
 FIG. 8 is an exploded top perspective view similar to FIG. 7 except that the cover is inverted.
 The other sides of the left vessel in FIGS. 7 and 8 are similar to that shown.

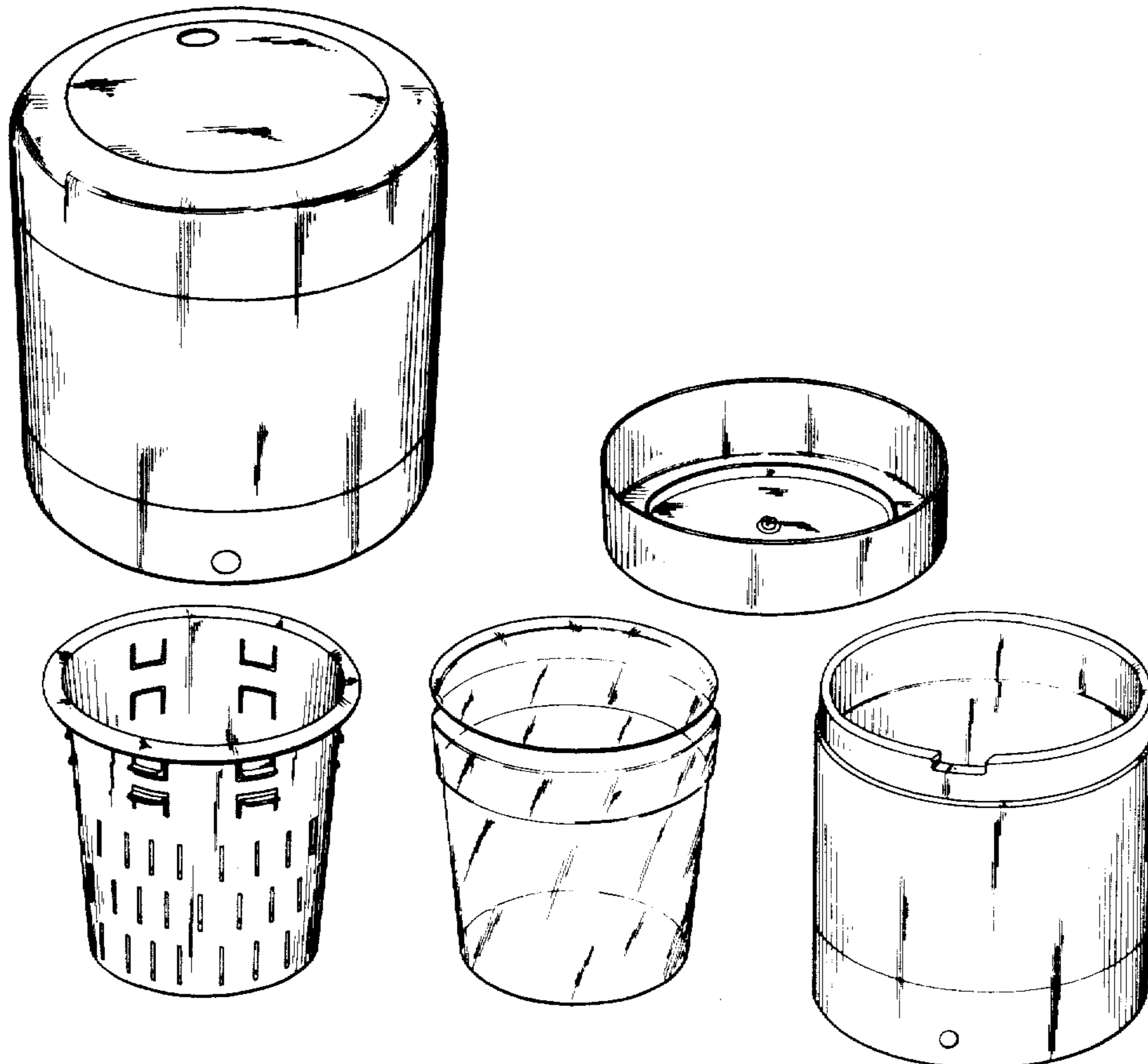

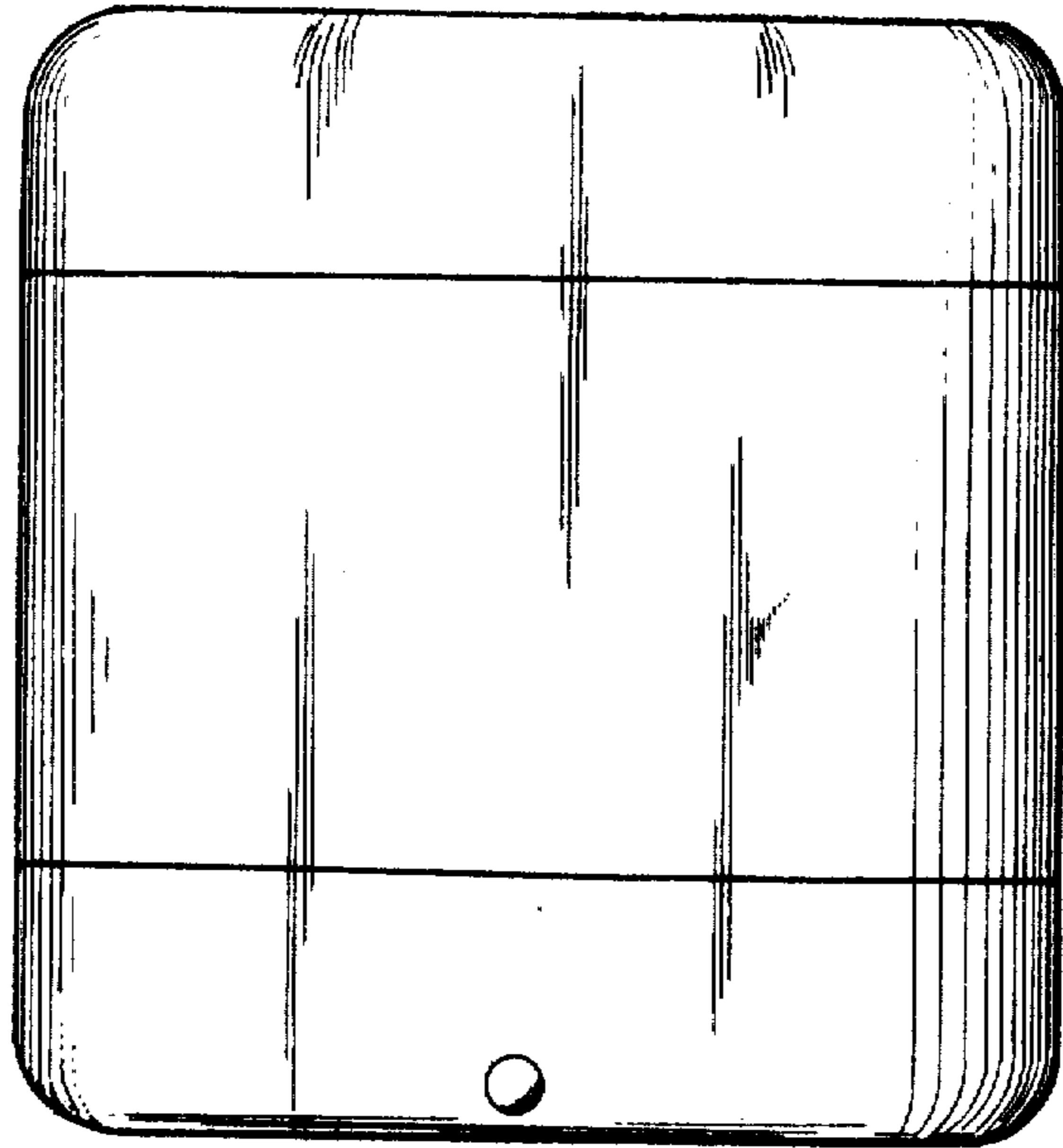

FIG. 1

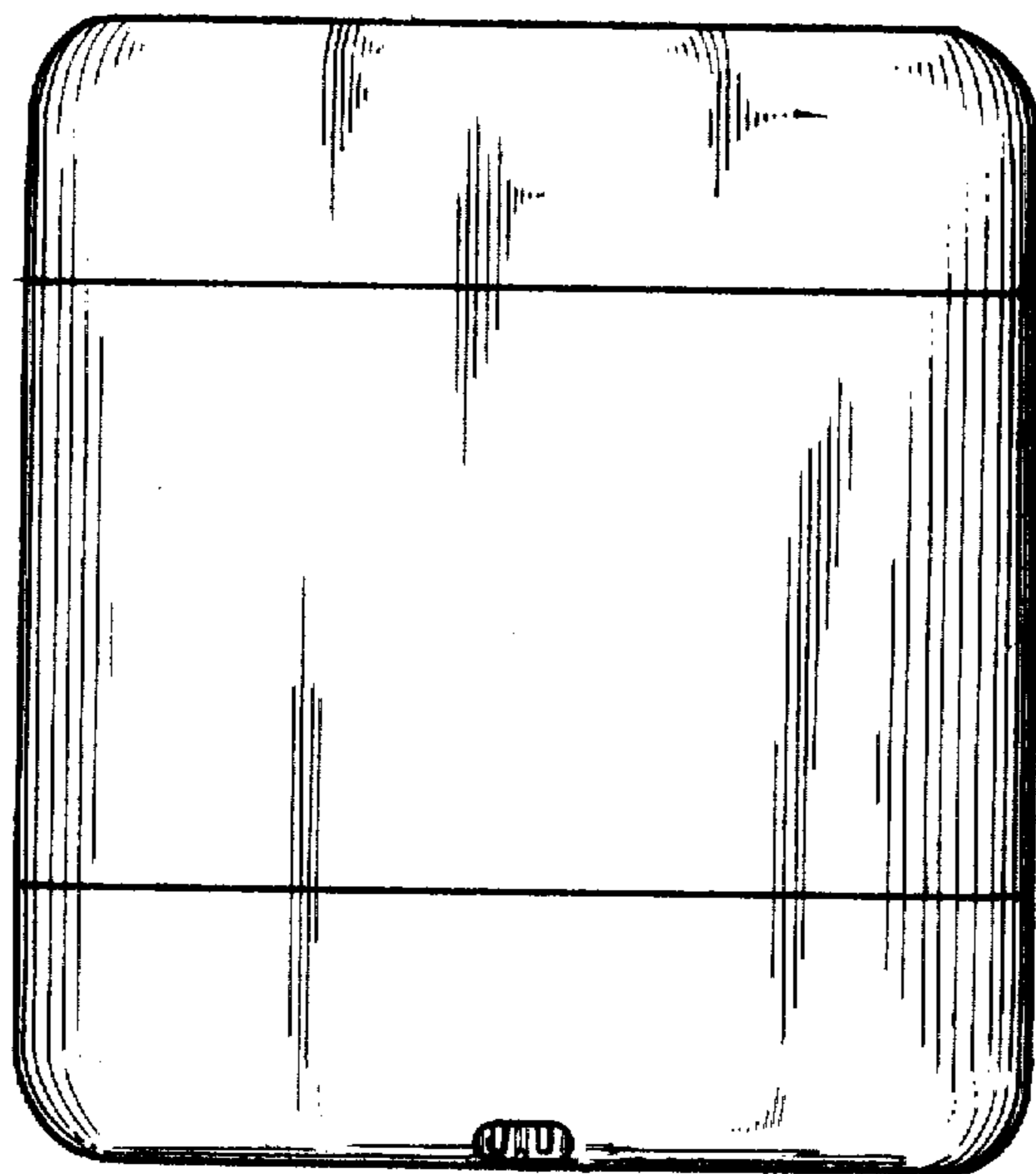

FIG. 2

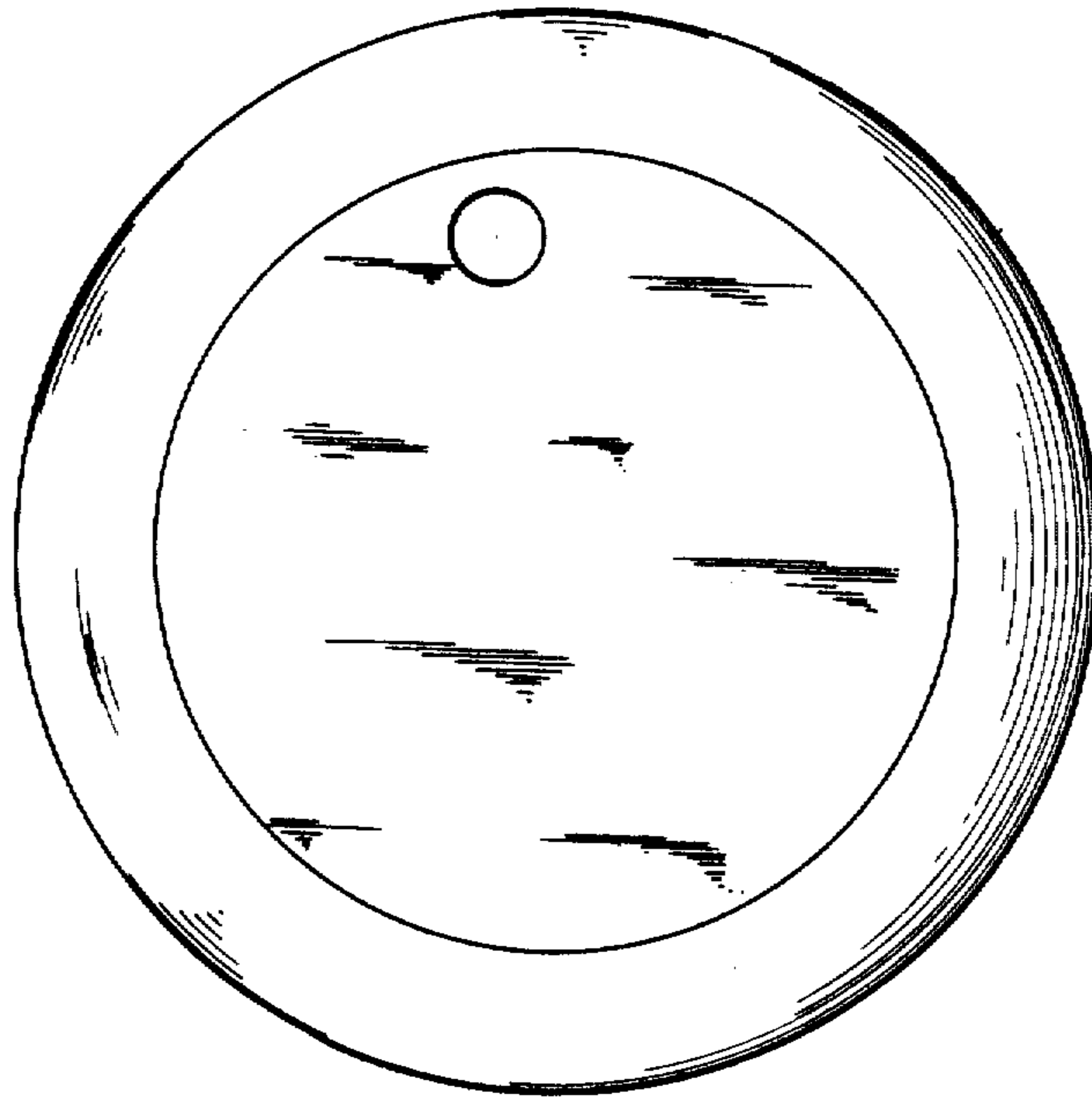

FIG. 3

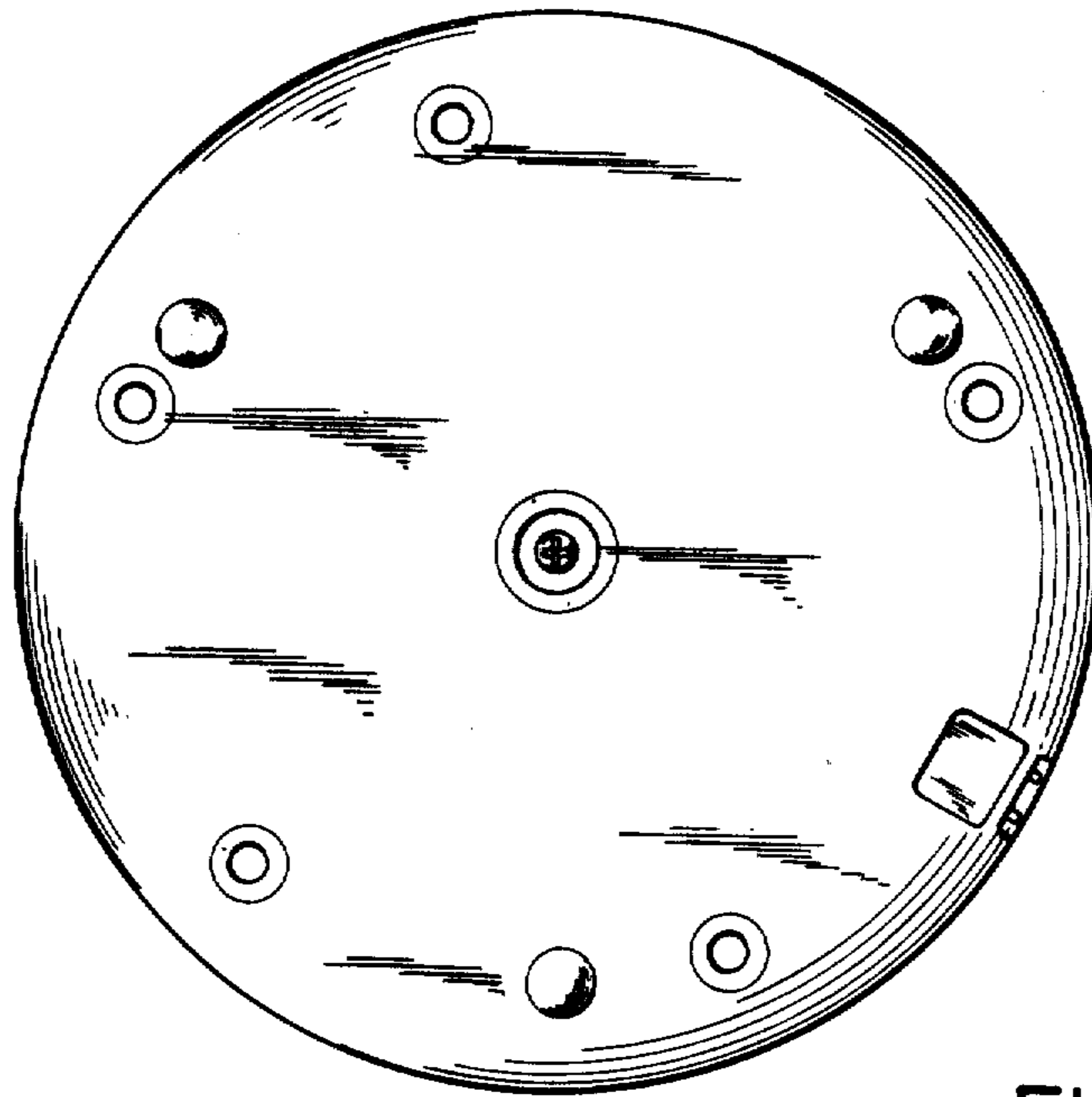

FIG. 4

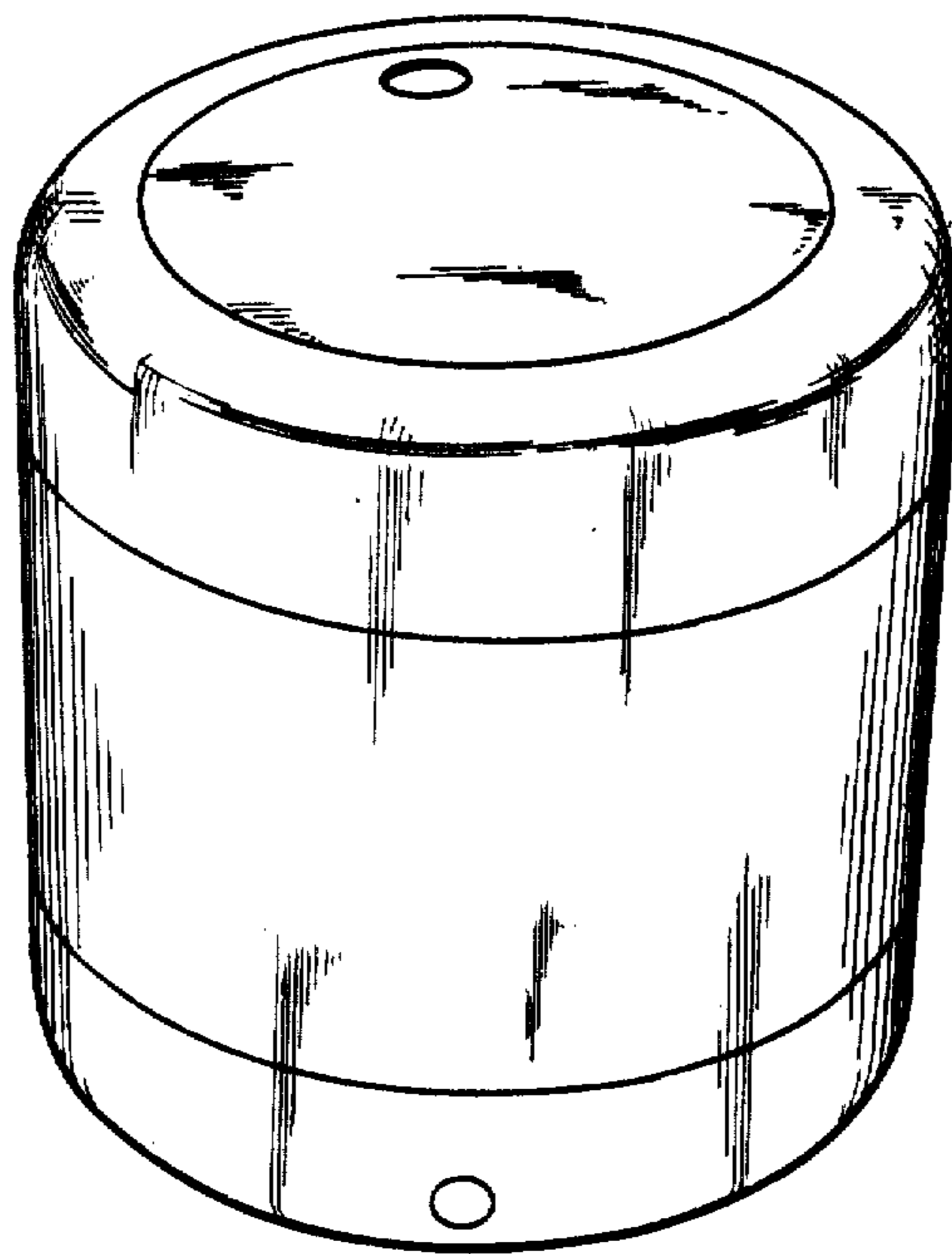

FIG. 5

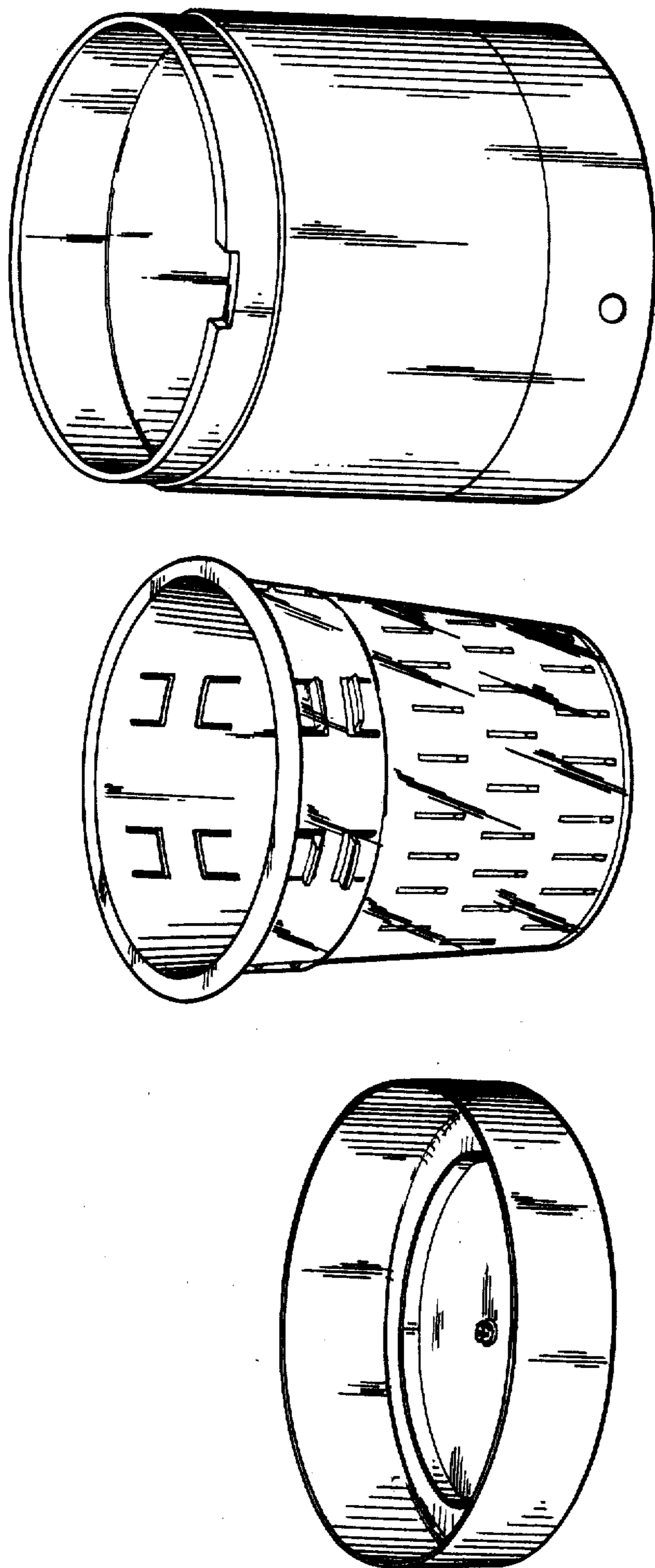

FIG. 6

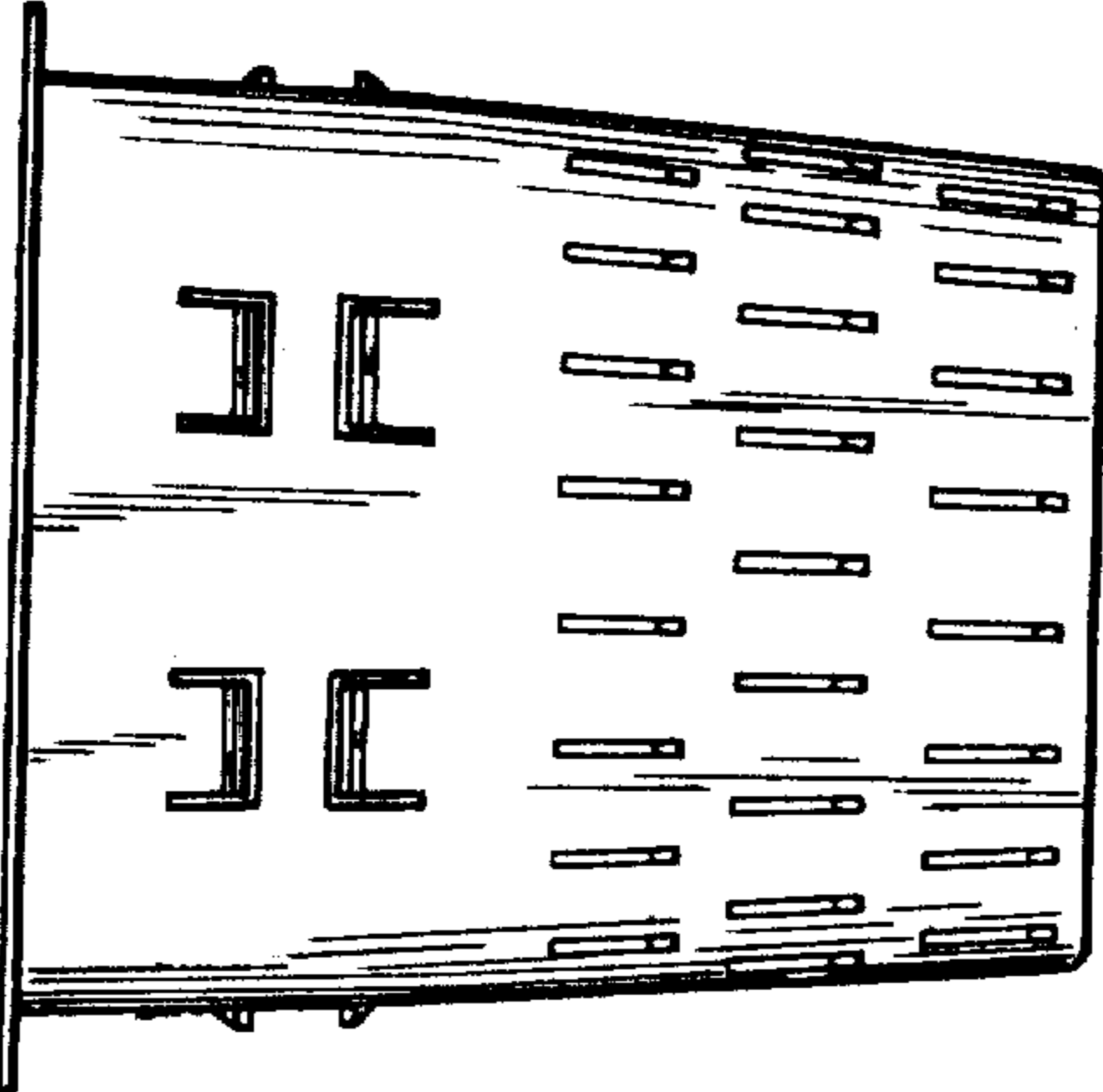
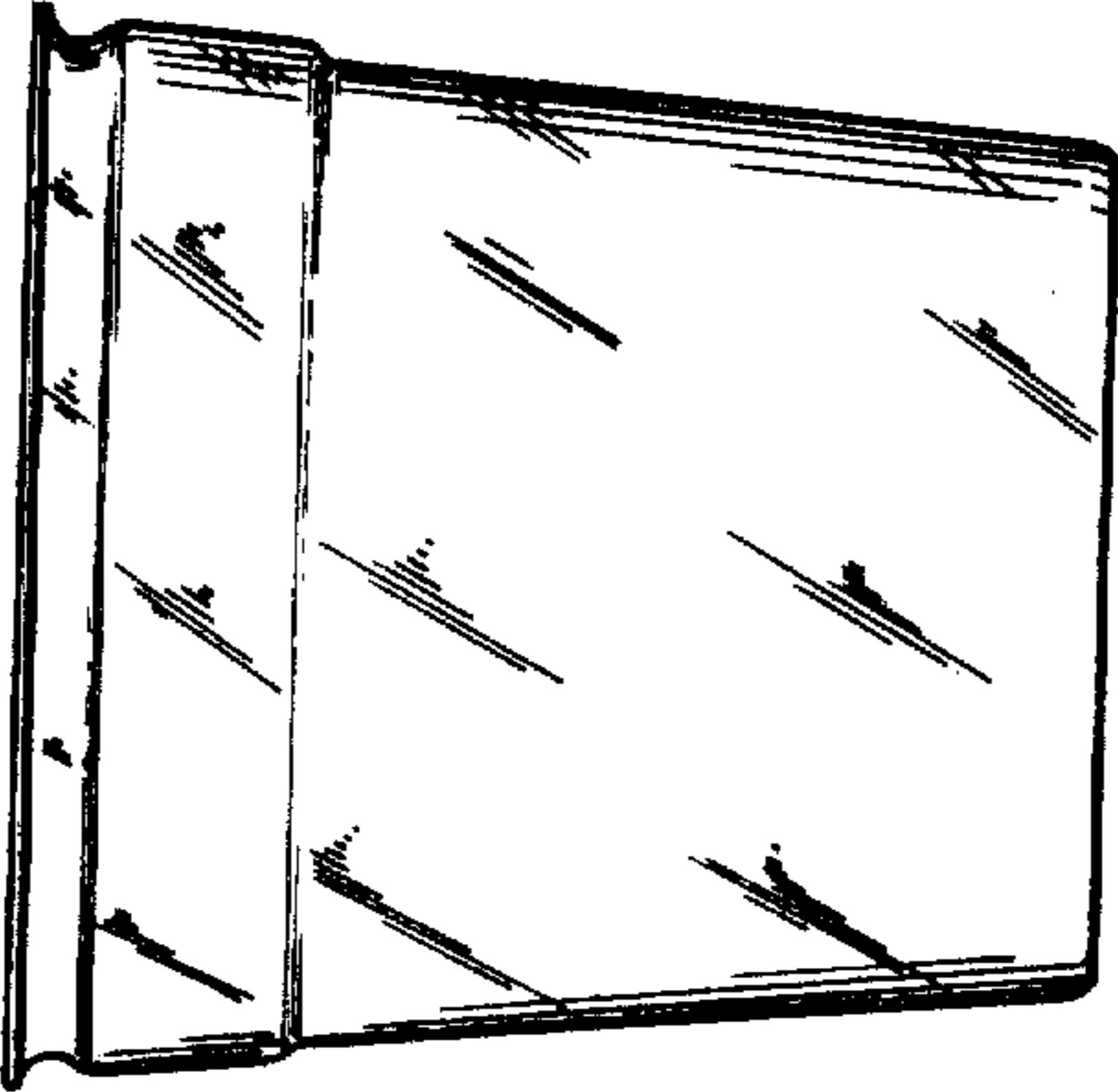
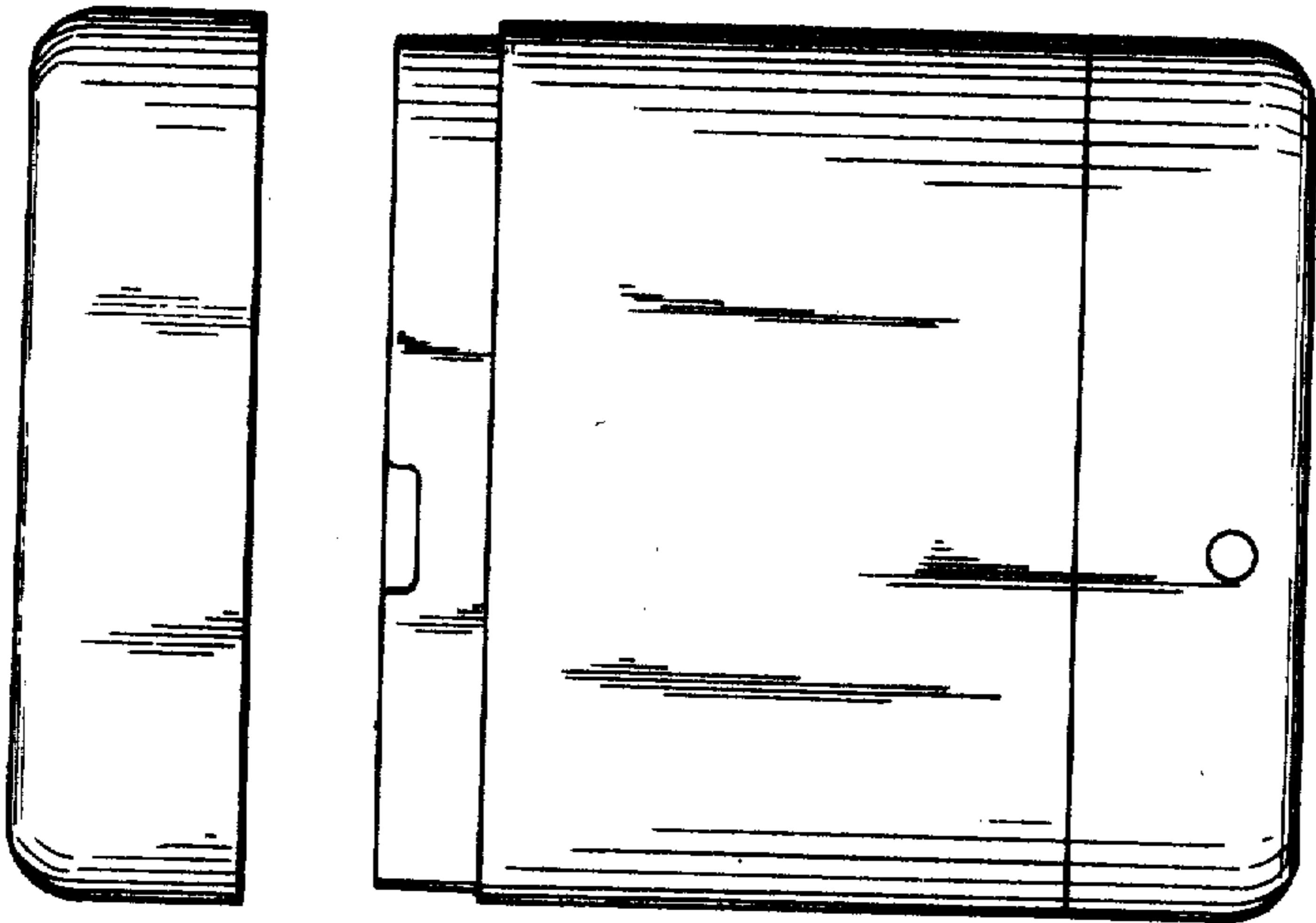

FIG-7

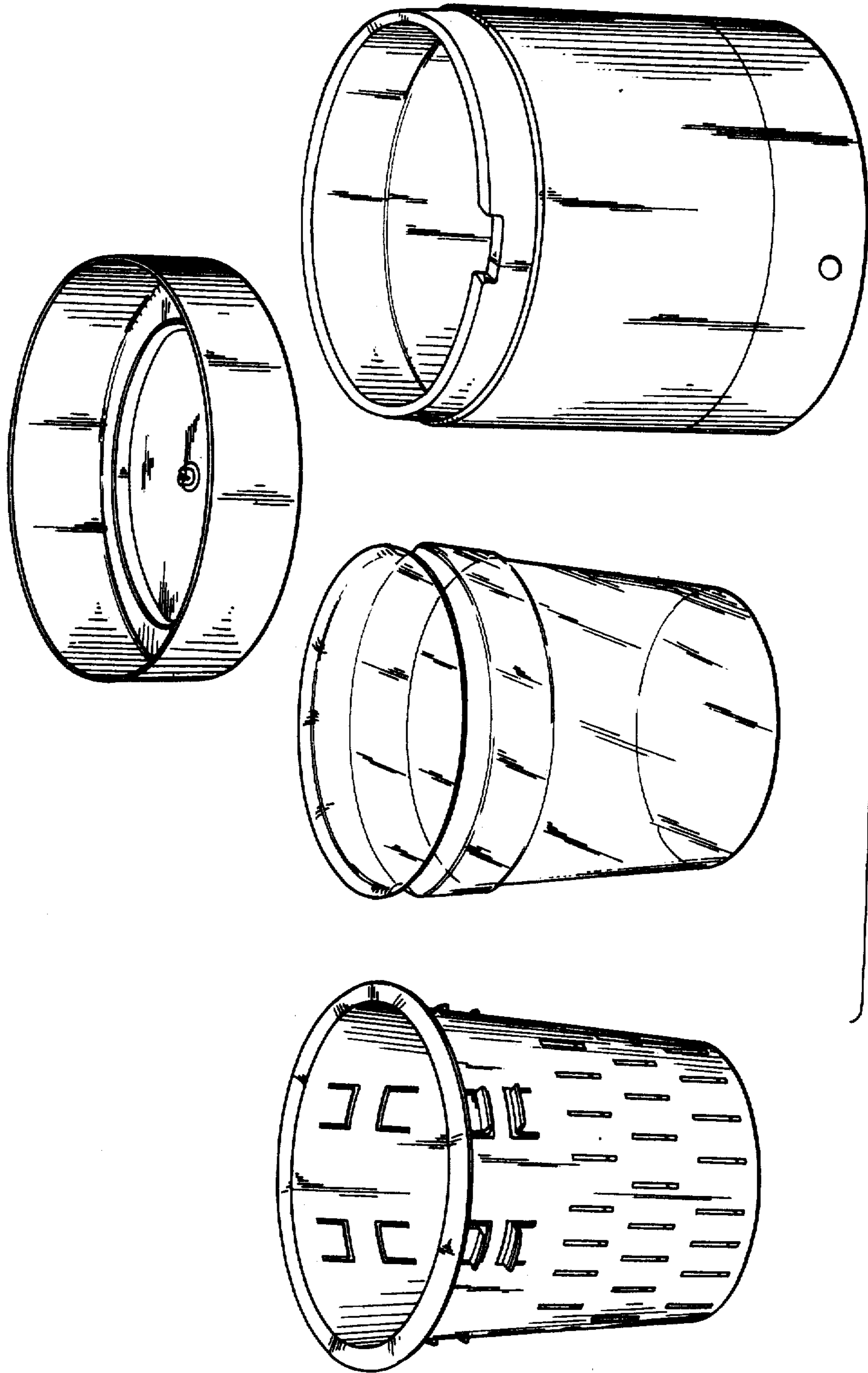

FIG. 8