

[54] TOY AIRPLANE

[76] Inventor: Bernard R. Barrett, 305 Graham St., Lombard, Ill. 60148

[**] Term: 14 Years

[21] Appl. No.: 63,349

[22] Filed: Aug. 2, 1979

[51] Int. Cl. D21-01

[52] U.S. Cl. D21/89

[58] Field of Search D21/82, 87, 88, 89, D21/90, 93, 109; 46/1 R, 1 H, 1 L, 60, 74 R, 76 R, 77, 79, 80; 273/426, 427; 244/153 R, 153 A, 154, 155 R, 155 A; D59/1, 2 R

[56] References Cited

U.S. PATENT DOCUMENTS

927,815	7/1909	Rupp	46/79
3,714,734	2/1973	Livingston	46/79
4,170,084	10/1979	Fierheller	46/79

OTHER PUBLICATIONS

The Great International Paper Airplane Book, ©1967, Plane #6.

Primary Examiner—Charles A. Rademaker
Attorney, Agent, or Firm—Oltsch, Knoblock & Hall

[57] CLAIM

The ornamental design for a toy airplane, as shown and described.

DESCRIPTION

FIG. 1 is a front perspective view of a toy airplane showing my new design;
 FIG. 2 is a top plan view thereof;
 FIG. 3 is a side elevational view thereof;
 FIG. 4 is a rear elevational view thereof; and
 FIG. 5 is a bottom plan view thereof.
 FIG. 6 is a front perspective view of another embodiment of the design shown in FIGS. 1 through 5;
 FIG. 7 is a top plan view thereof;
 FIG. 8 is a side elevational view thereof;
 FIG. 9 is a rear elevational view thereof; and
 FIG. 10 is a bottom plan view thereof.

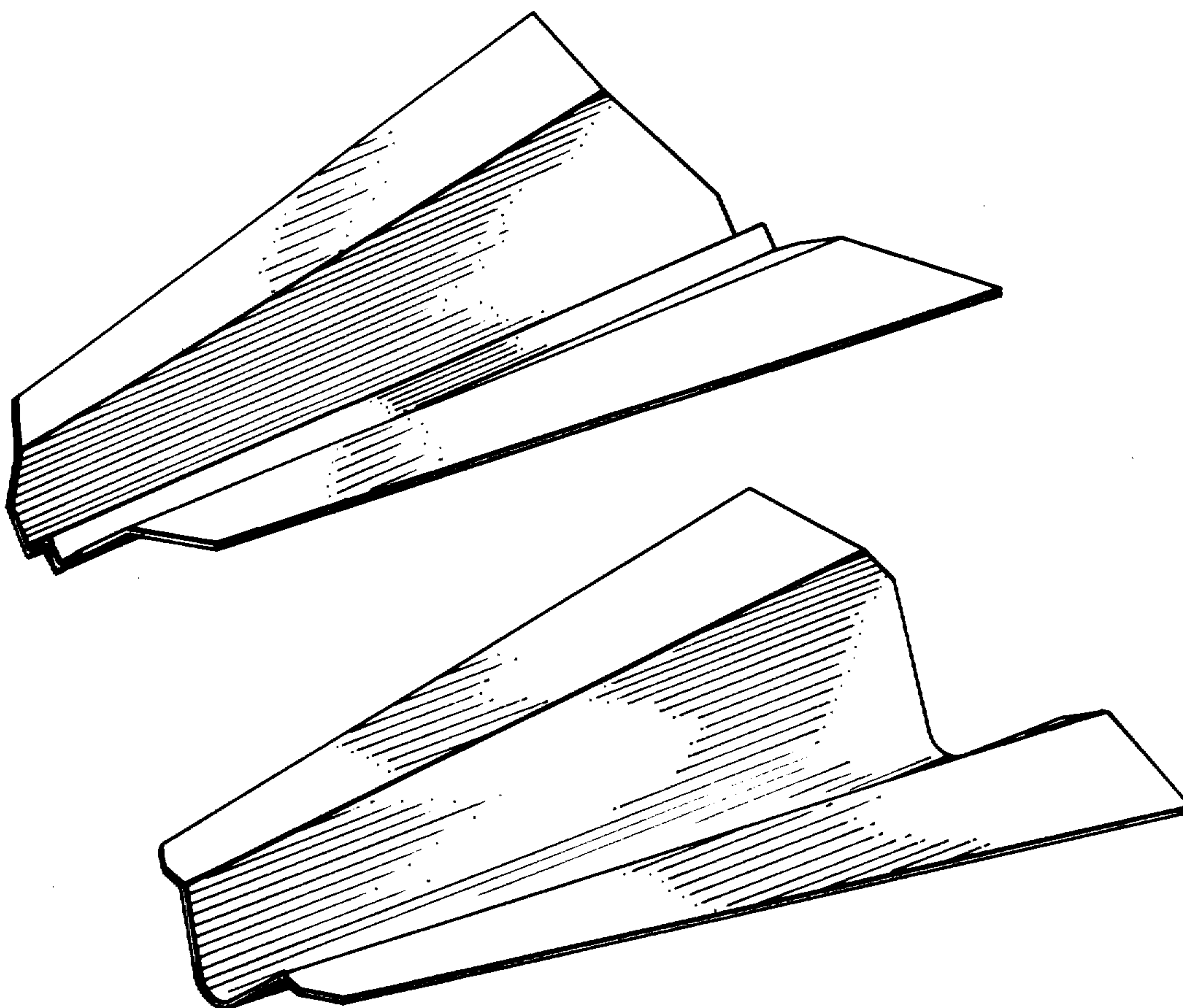

Fig. 1

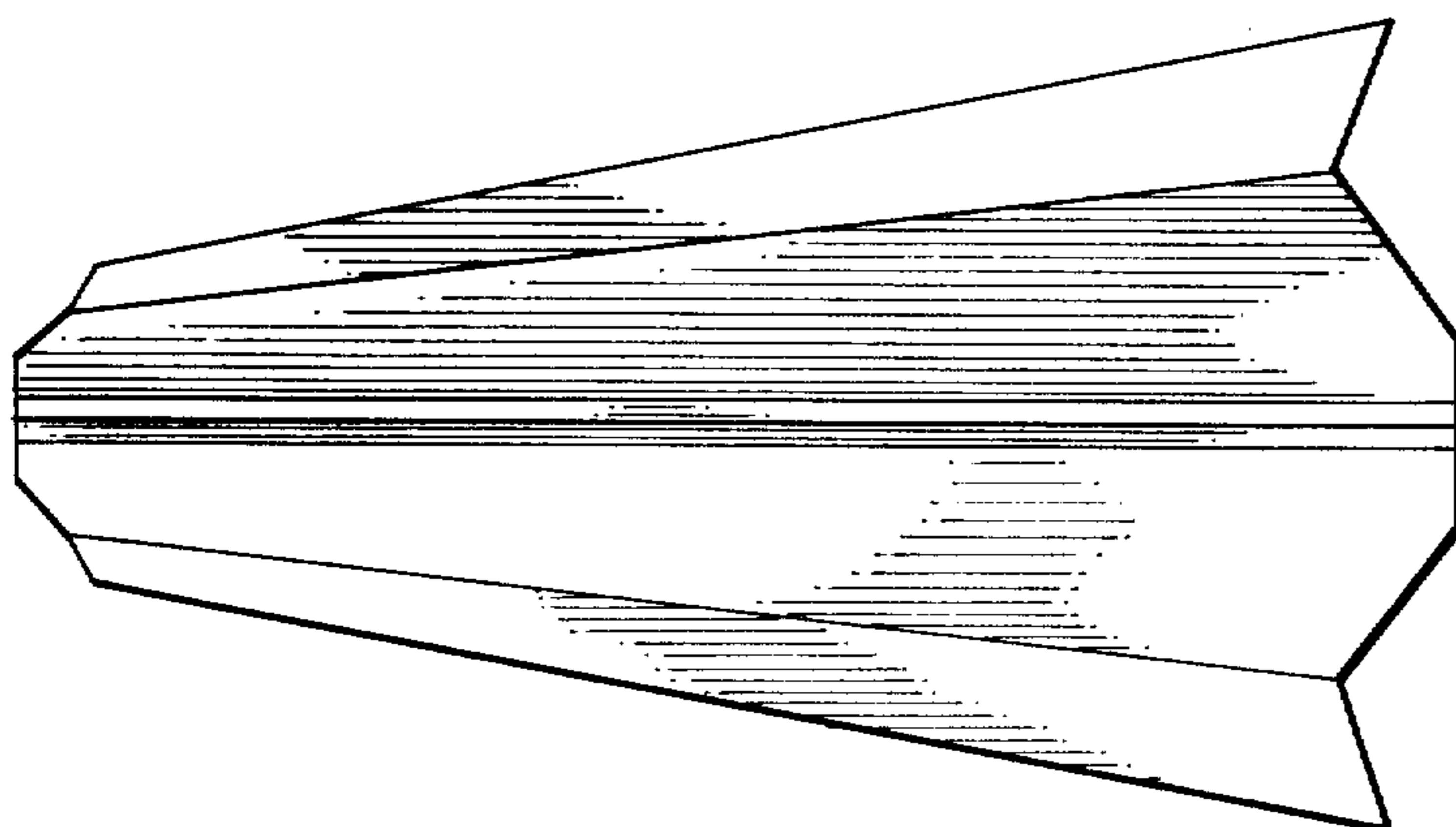
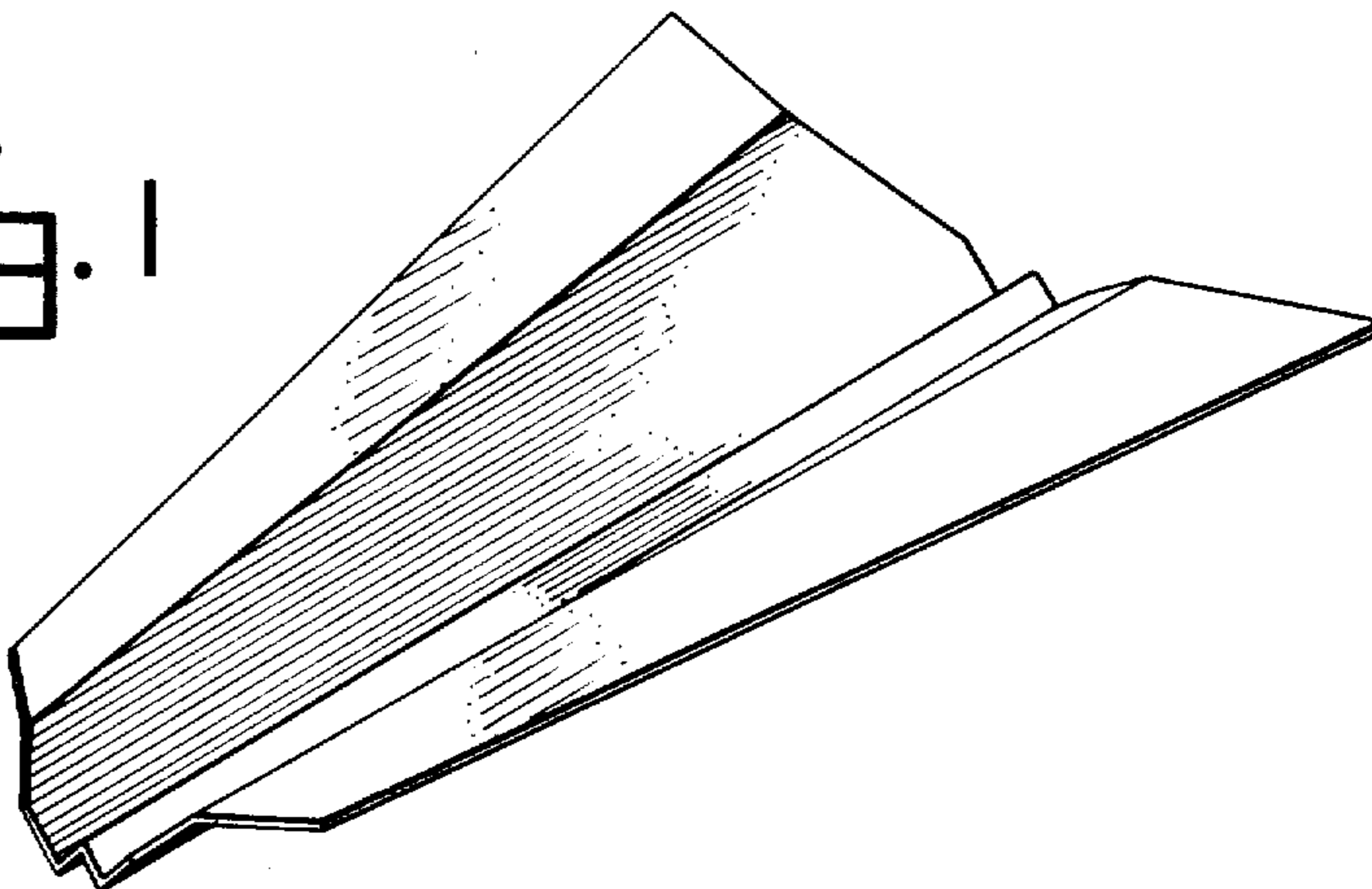

Fig. 2

Fig. 3

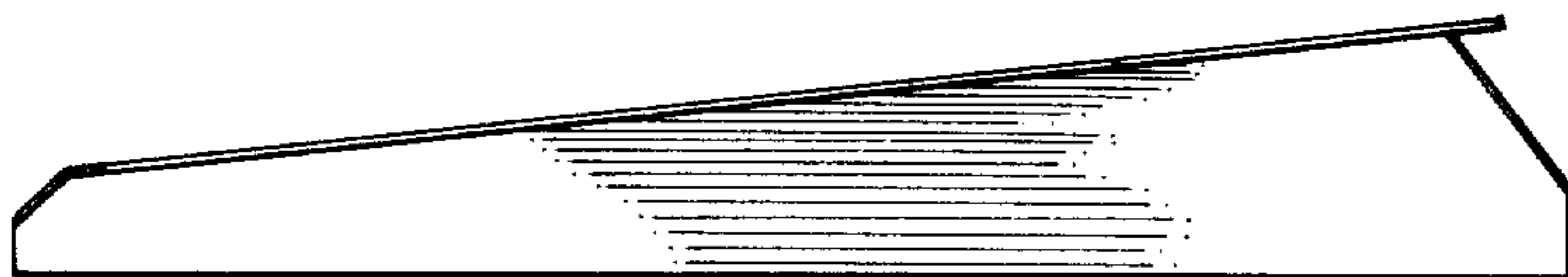

Fig. 4

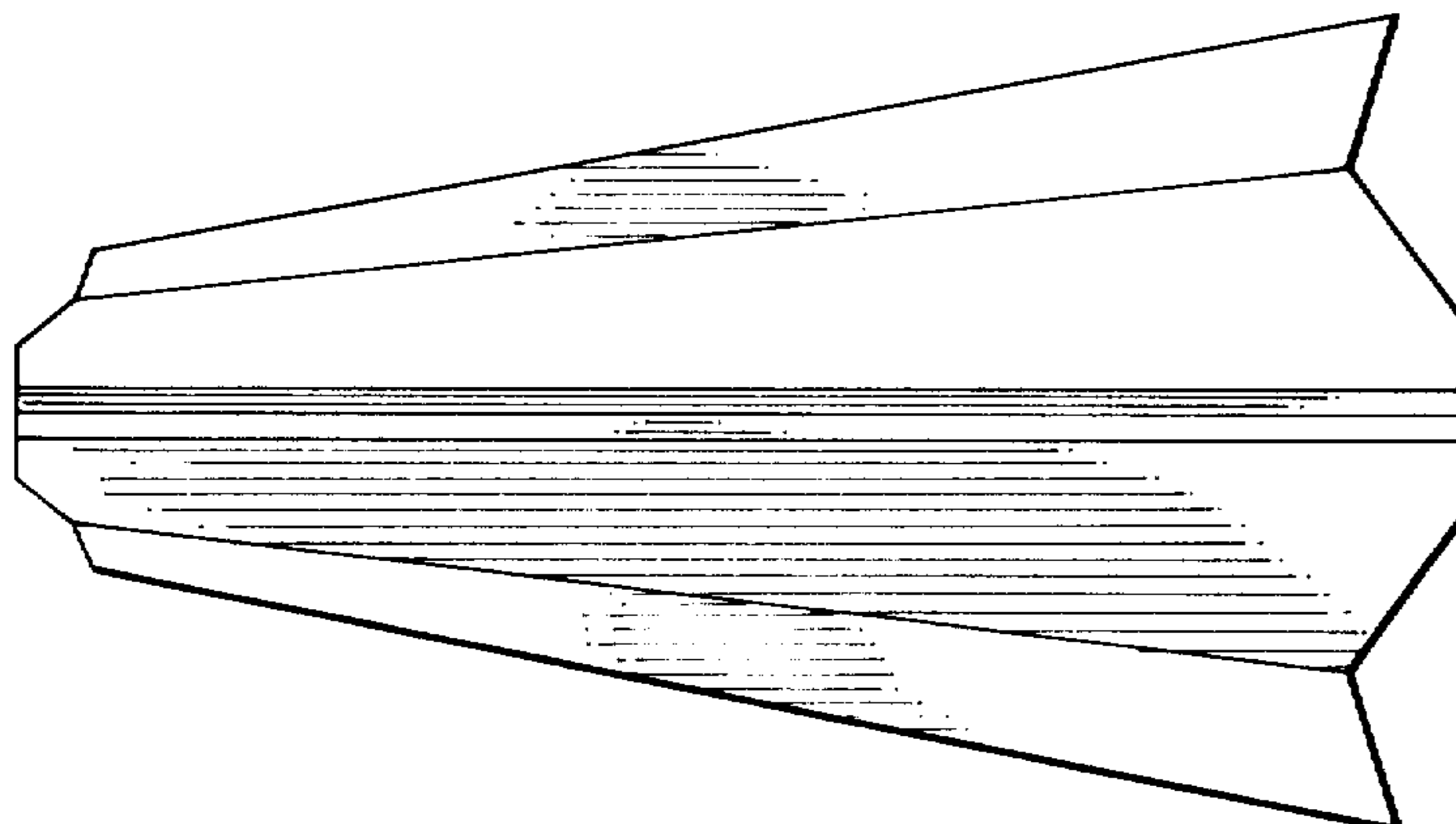

Fig. 5

Fig. 6

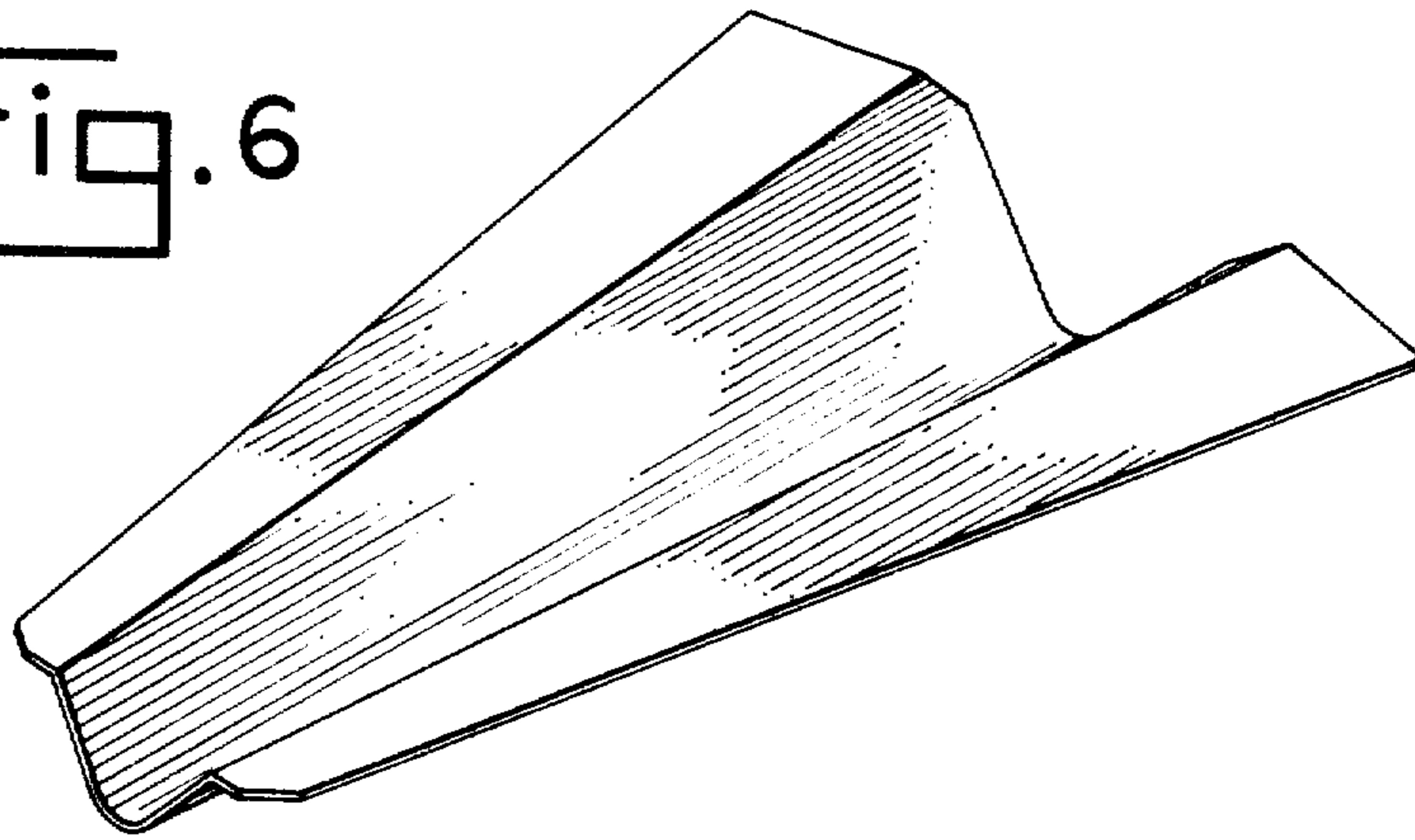

Fig. 7

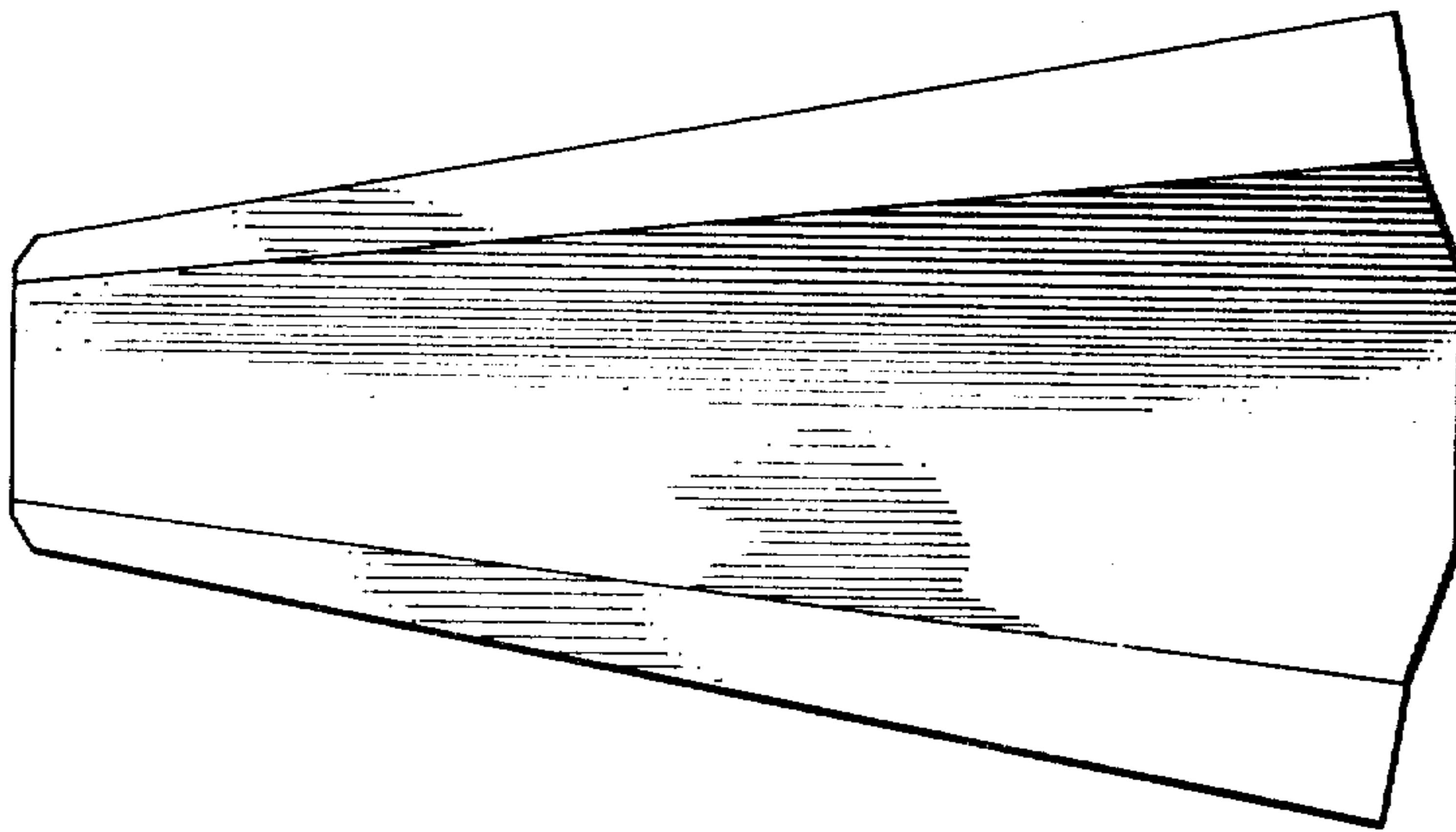

Fig. 8



Fig. 9



Fig. 10

