

[54] TOY DESK

[76] Inventor: Frederick H. Kroll, 72 Wood Hollow La., New Rochelle, N.Y. 10804

[**] Term: 14 Years

[21] Appl. No.: 68,607

[22] Filed: Aug. 22, 1979

[51] Int. Cl. D21-01

[52] U.S. Cl. D21/59; D21/121

[58] Field of Search D21/59, 109, 127, 126, D21/113, 121; D19/64, 59; D18/14, 13; D6/138; 35/26, 27; 46/1 R

[56] References Cited

U.S. PATENT DOCUMENTS

- D. 246,870 1/1978 Kalb et al. D18/14
- D. 250,491 12/1978 Ogawa D21/59

D. 257,439 10/1980 Horii D21/59

Primary Examiner—Charles A. Rademaker
Attorney, Agent, or Firm—McAulay, Fields, Fisher,
Goldstein & Nissen

[57] CLAIM

The ornamental design for a toy desk, as shown and described.

DESCRIPTION

FIG. 1 is a front elevational view of a toy desk showing my new design;
 FIG. 2 is a right side elevational view thereof, the side opposite being substantially a mirror image;
 FIG. 3 is a top plan view thereof;
 FIG. 4 is a bottom plan view thereof;
 FIG. 5 is a rear elevational view thereof; and
 FIG. 6 is a top perspective view thereof showing the design in an open condition.

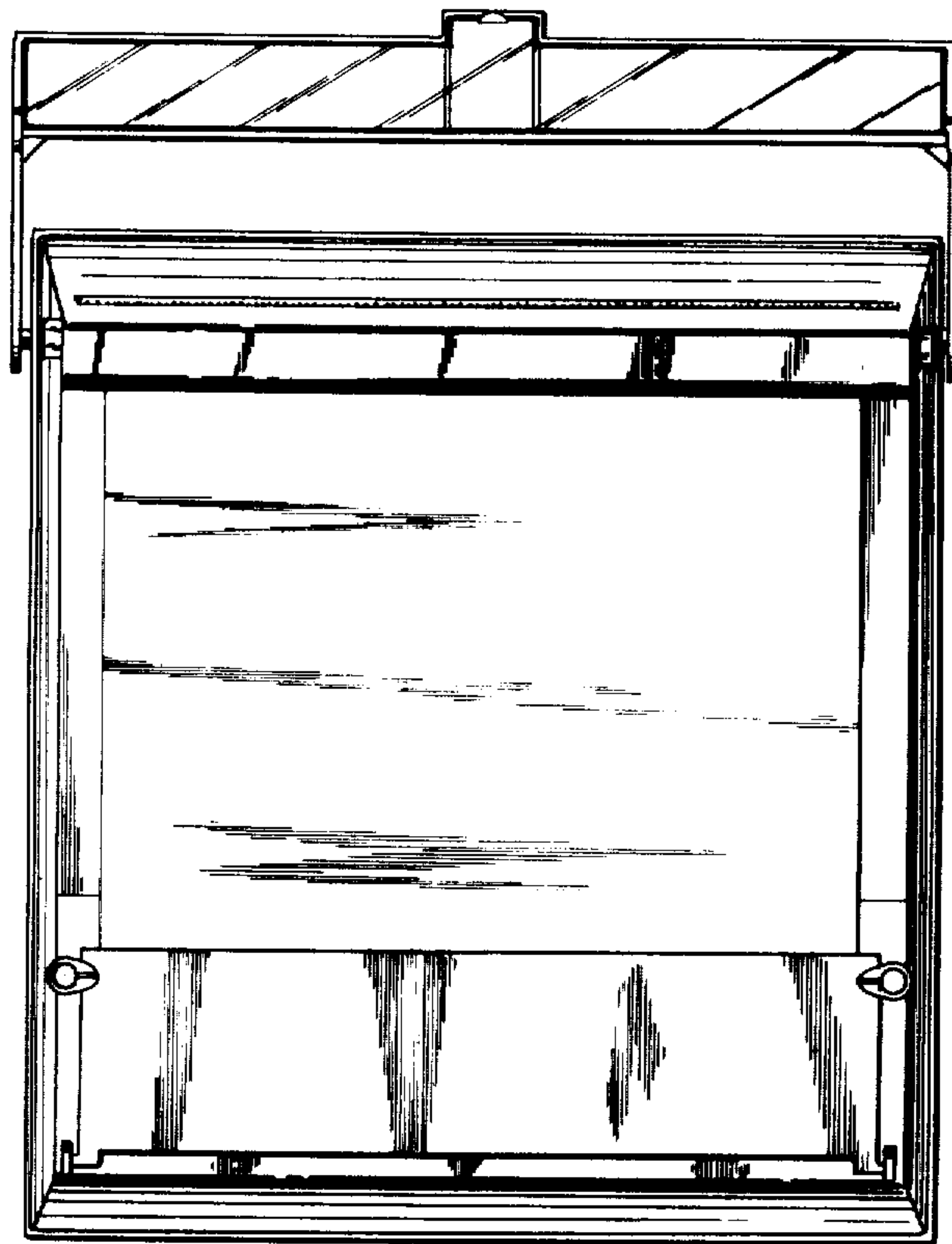

FIG. 1

FIG. 2

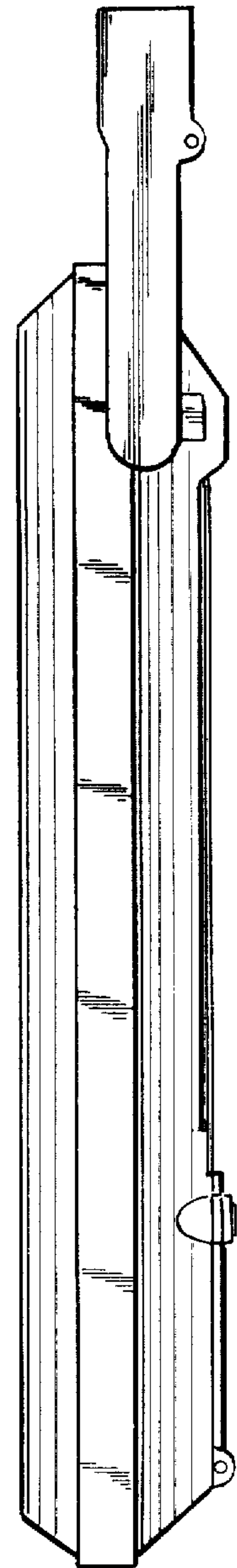
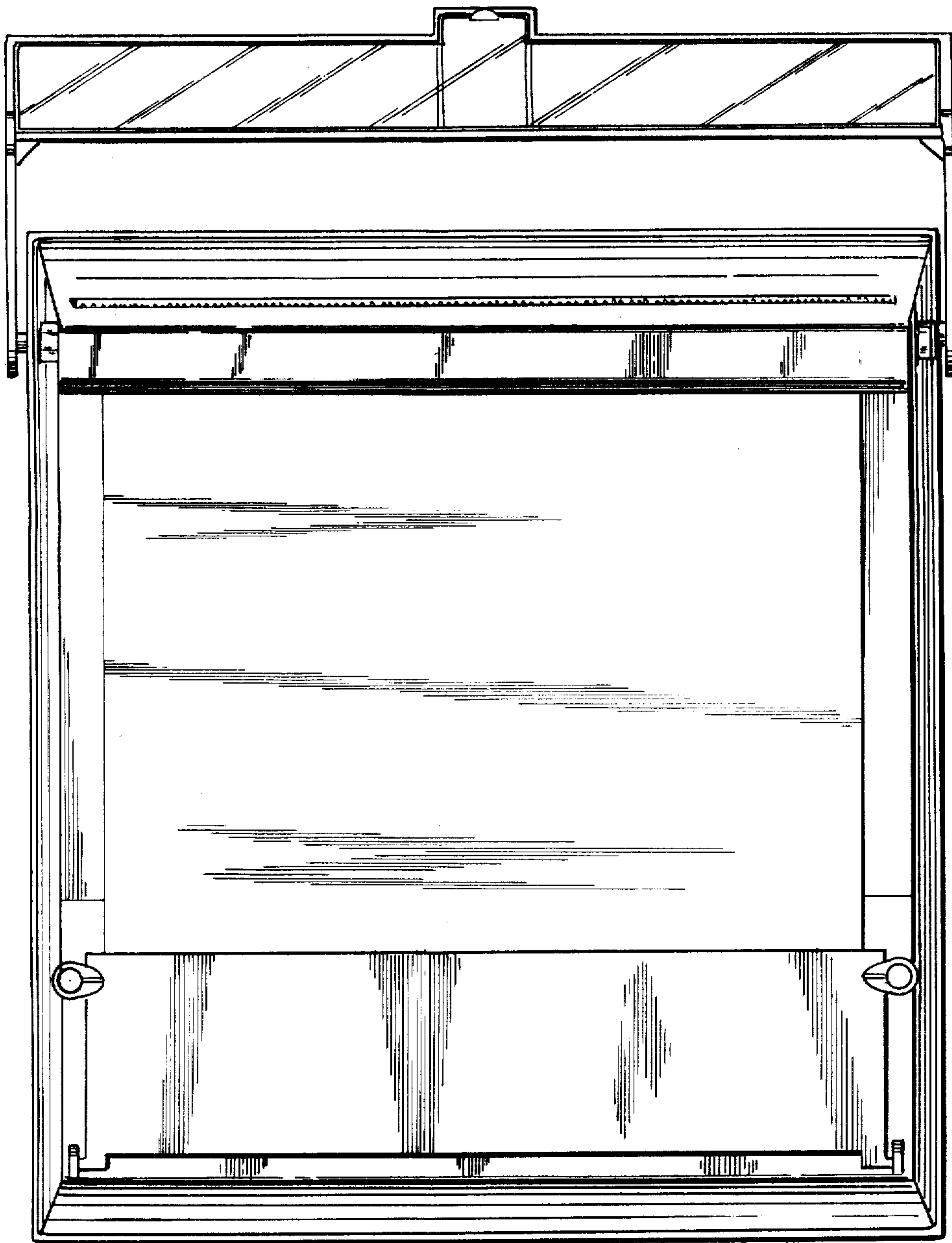

FIG. 3

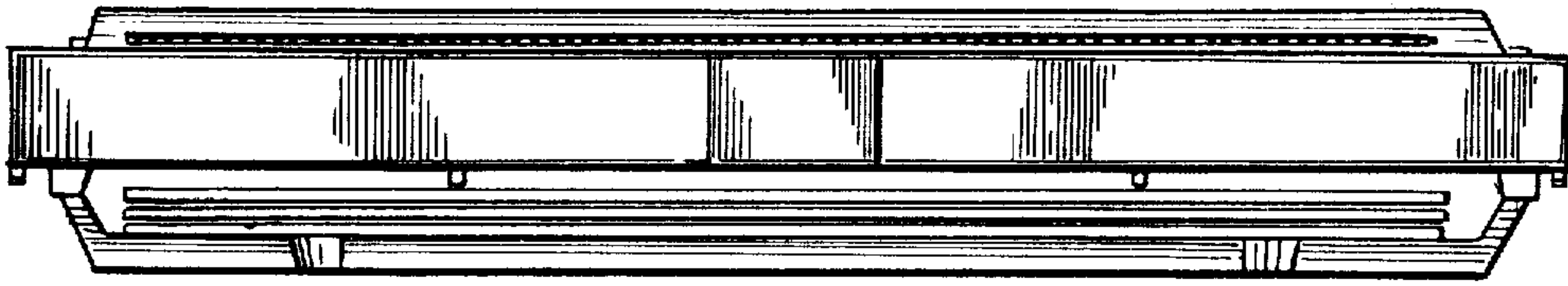

FIG. 4

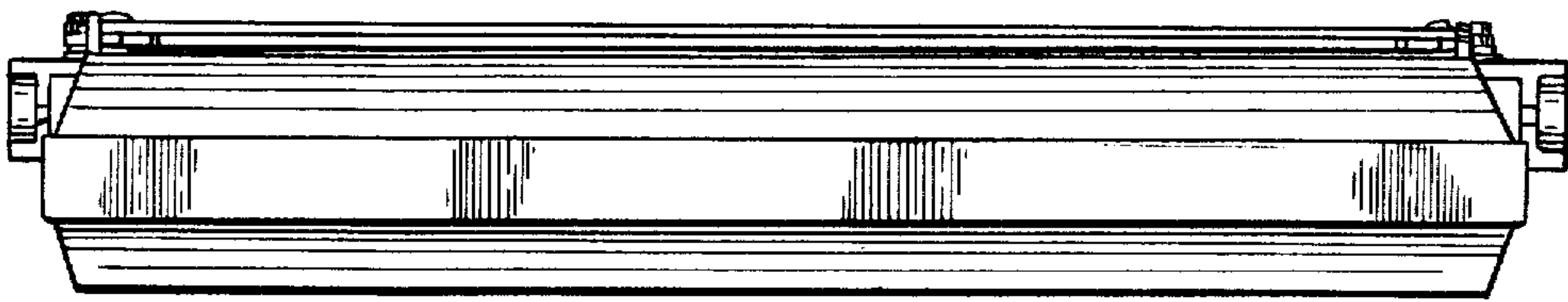
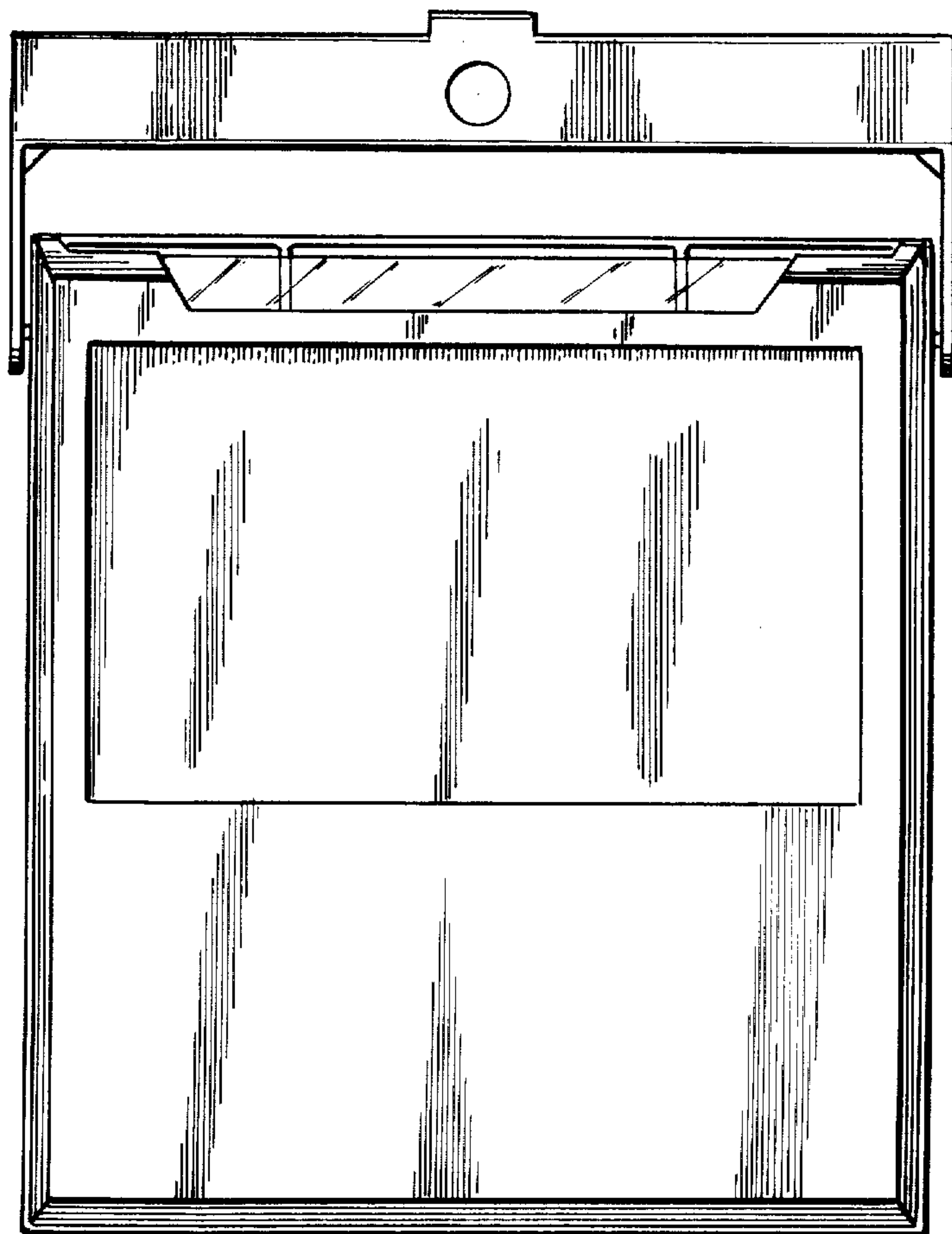

FIG. 5



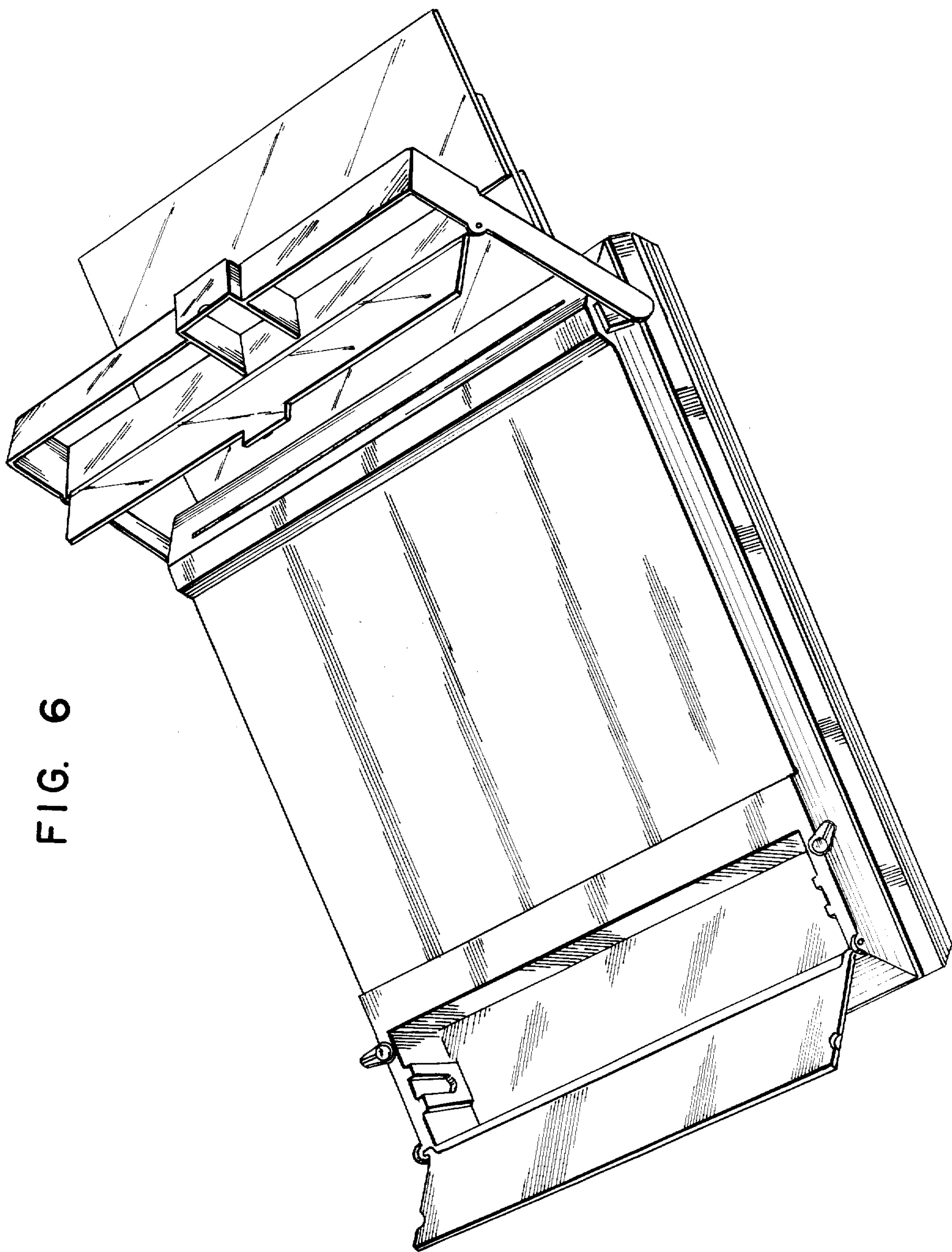

FIG. 6