

[54] CAMERA

[75] Inventor: Takaharu Kato, Tokyo, Japan

[73] Assignee: Ricoh Company, Ltd., Japan

[\*\*] Term: 3½ Years

[21] Appl. No.: 946,186

[22] Filed: Sep. 27, 1978

[30] Foreign Application Priority Data

Mar. 27, 1978 [JP] Japan ..... 53-11647

[51] Int. Cl. .... D16-01

[52] U.S. Cl. .... D16/08

[58] Field of Search ..... D16/1-10;  
354/126, 145, 152, 158, 170, 173, 174, 187, 202,  
288

[56] References Cited

U.S. PATENT DOCUMENTS

D. 222,845 1/1972 Matsuda et al. .... D16/8  
D. 234,820 4/1975 Kato ..... D16/8

Primary Examiner—Catherine E. Kemper  
Attorney, Agent, or Firm—McGlew and Tuttle

[57] CLAIM

The ornamental design for a camera, as shown.

DESCRIPTION

FIG. 1 is a front, top and left side perspective view of a camera showing my new design;  
FIG. 2 is a front elevational view thereof;  
FIG. 3 is a top plan view thereof;  
FIG. 4 is a right side elevational view thereof;  
FIG. 5 is a left side elevational view thereof;  
FIG. 6 is a rear elevational view thereof; and  
FIG. 7 is a bottom view thereof.

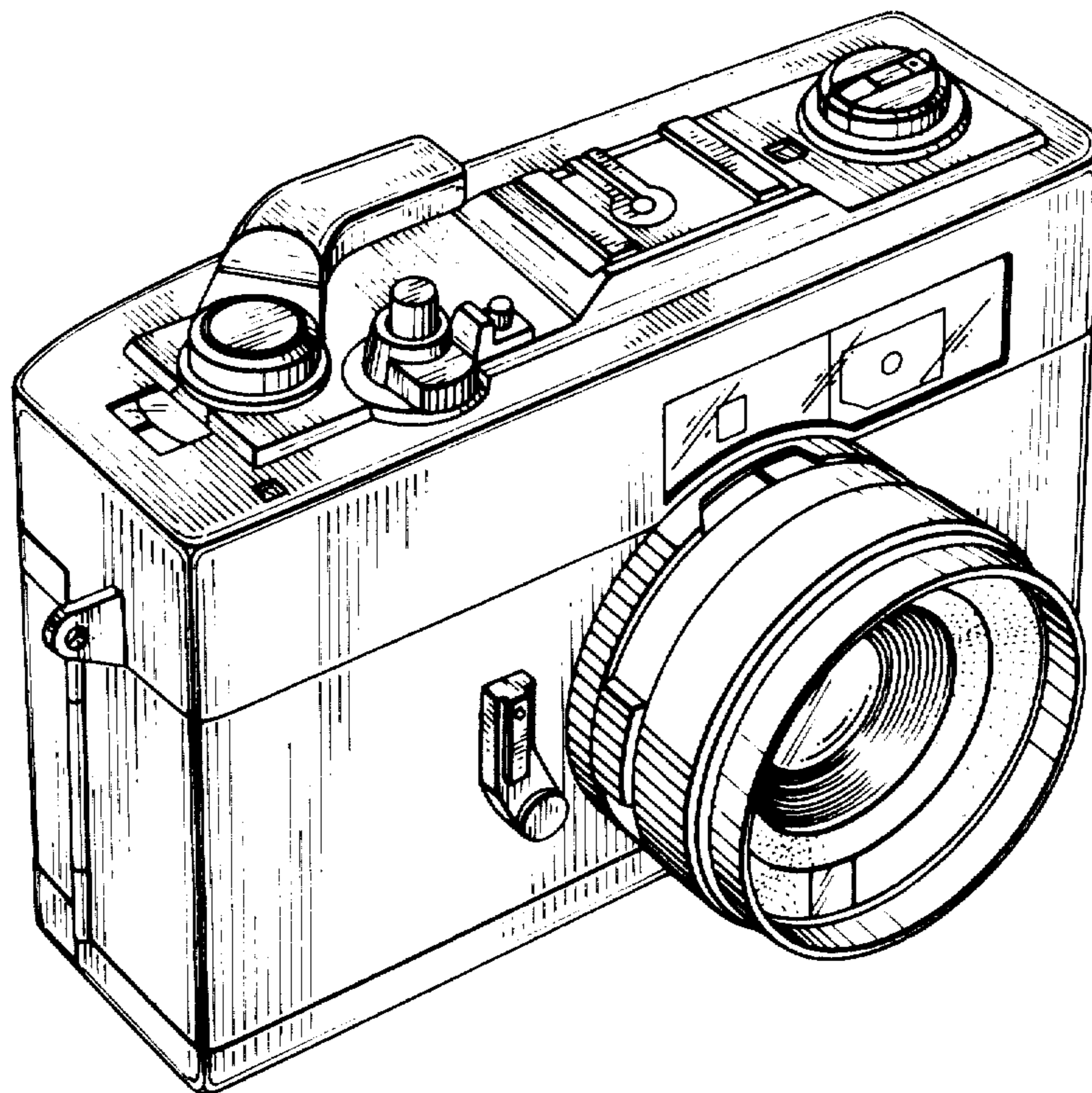

FIG. 1

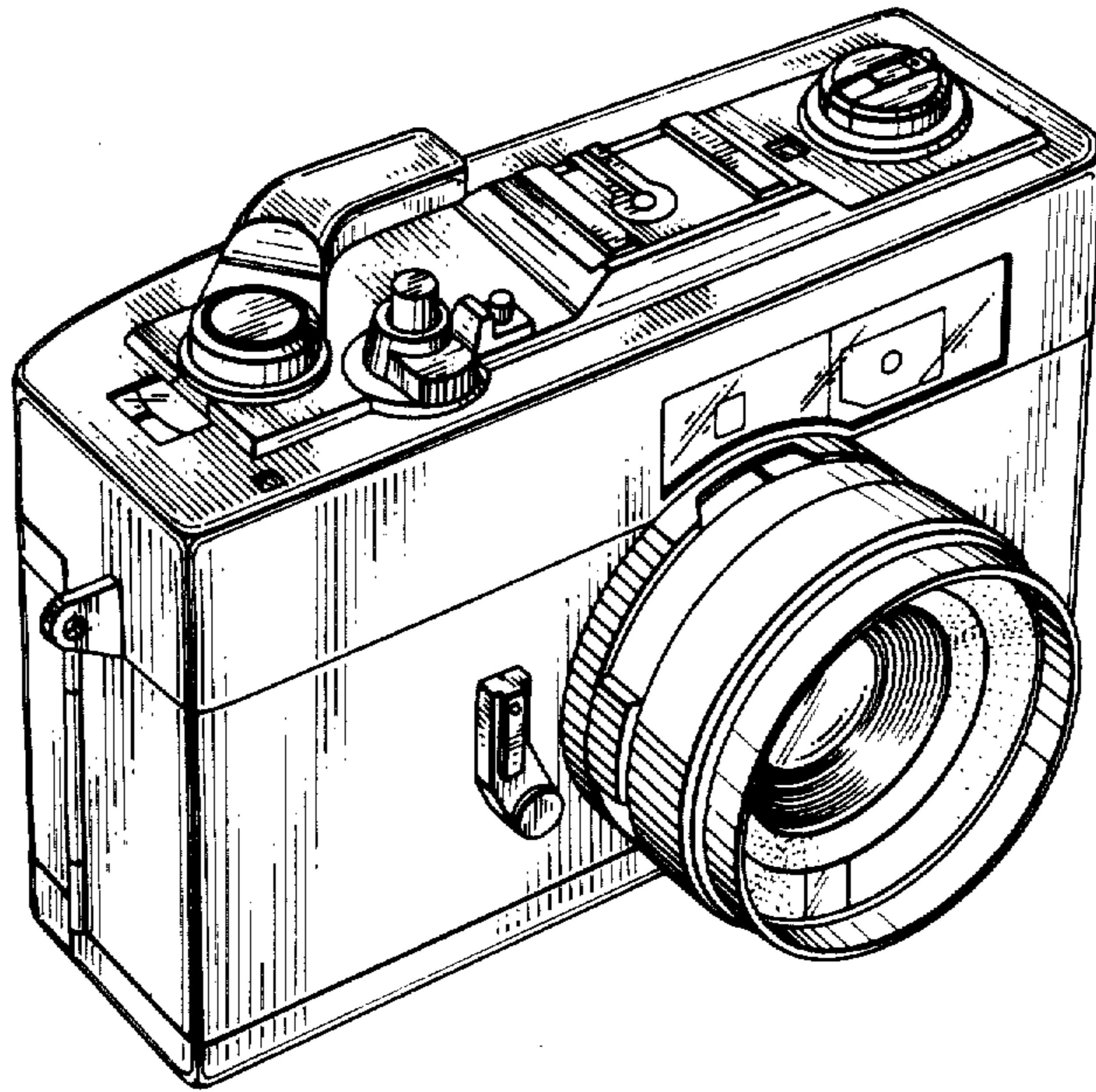

FIG. 2

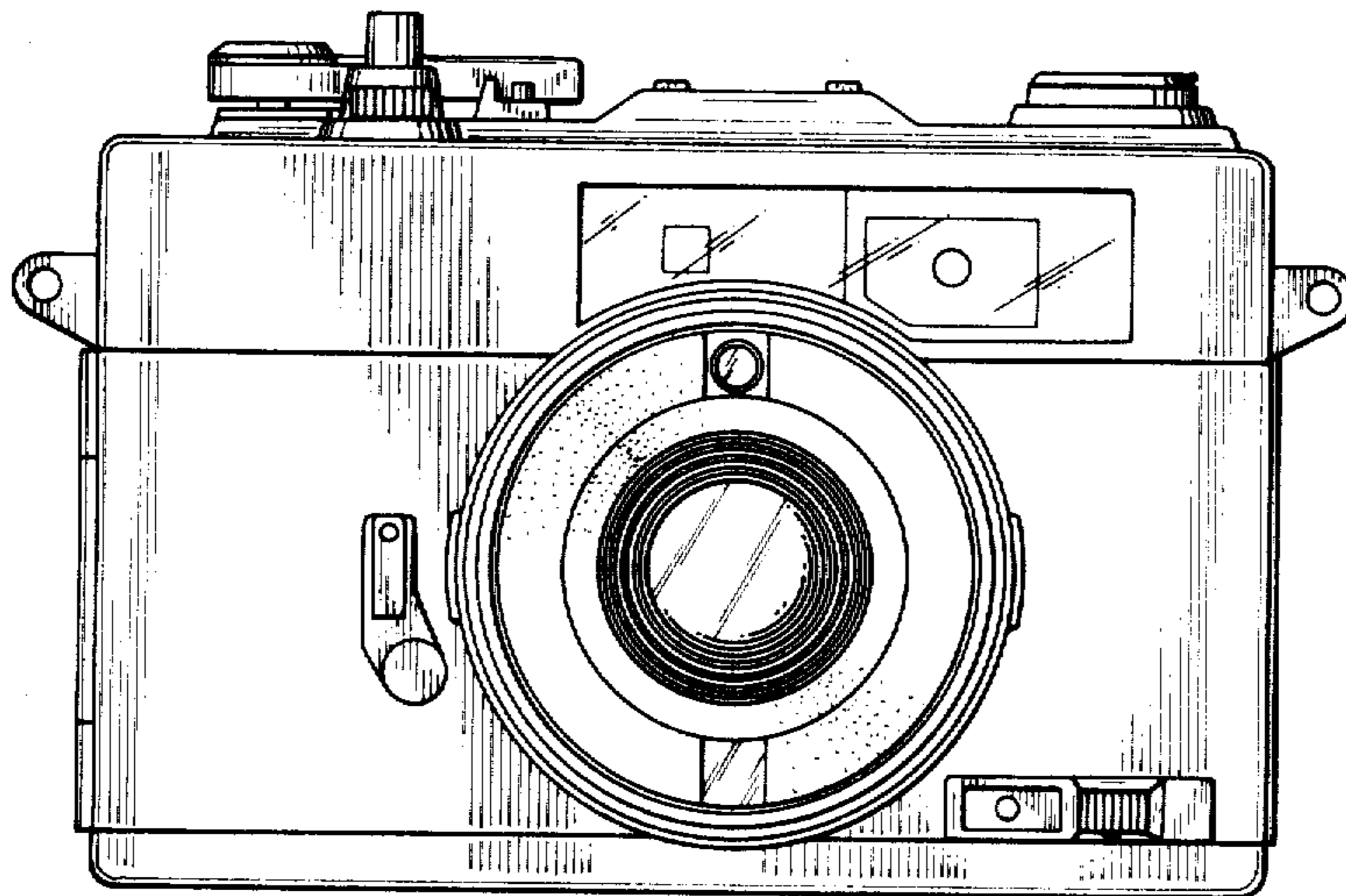

FIG. 3

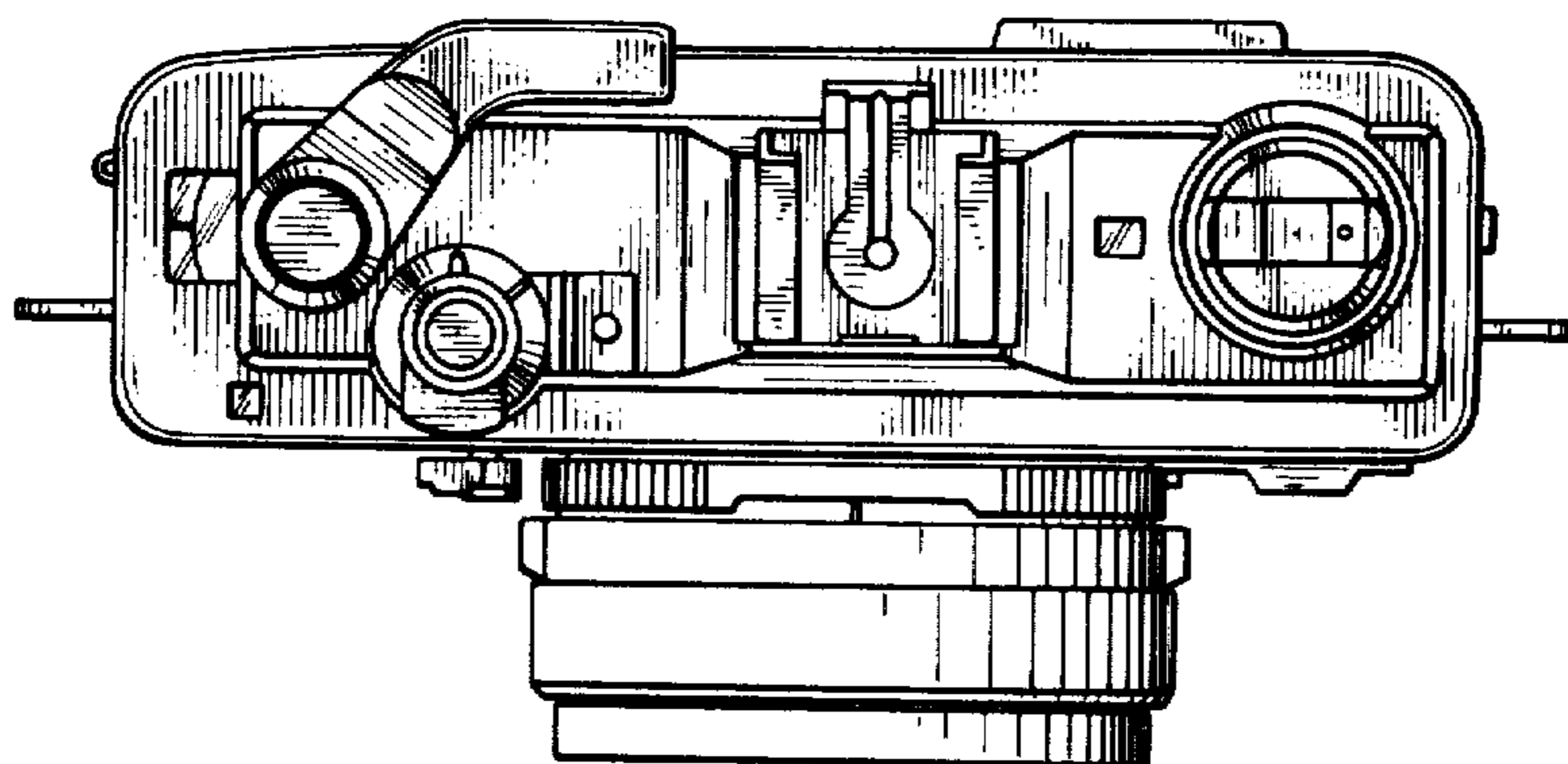

FIG. 4

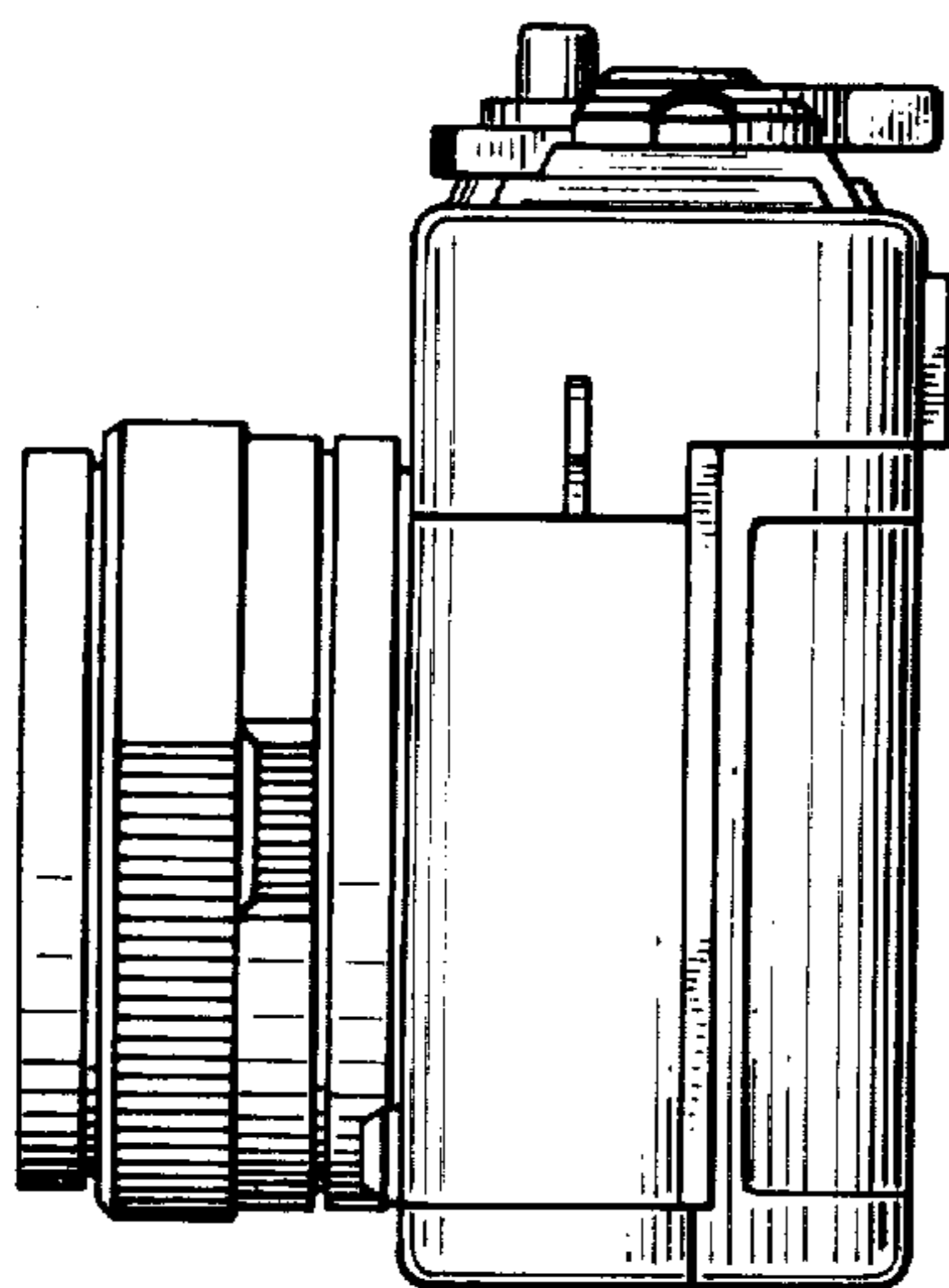

FIG. 5

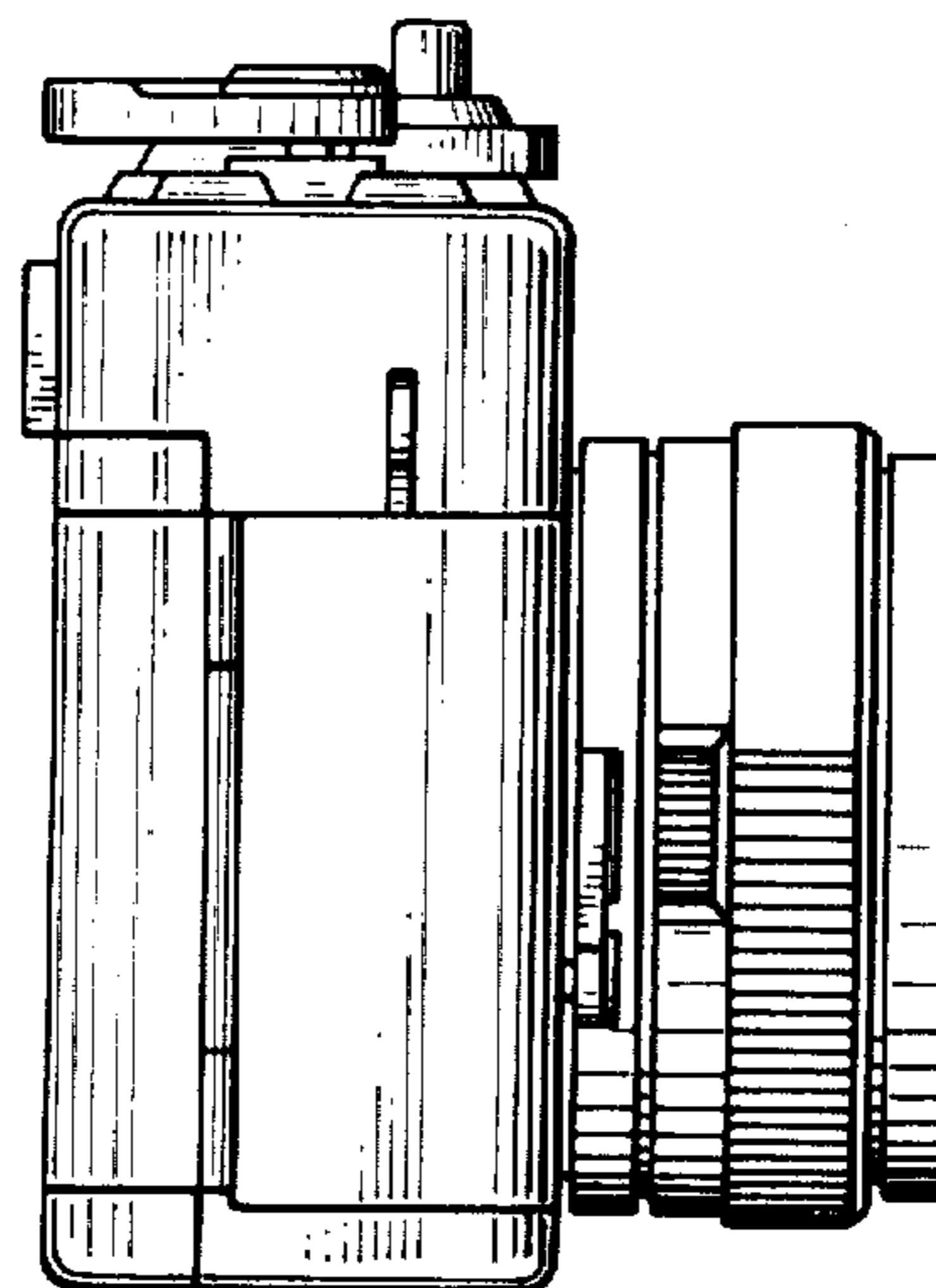

FIG. 6

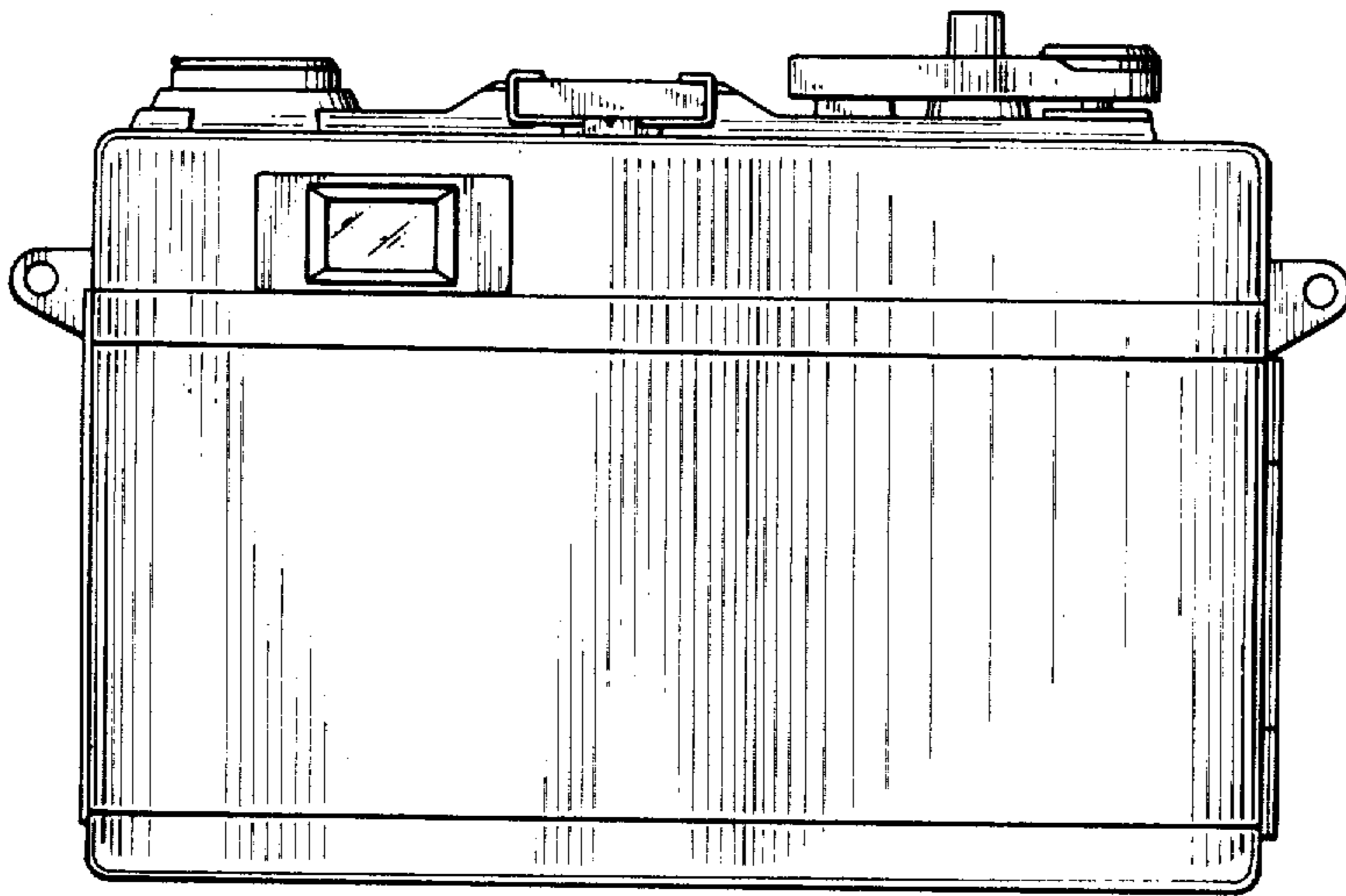

FIG. 7

