

[54] COMPUTER DISPLAY

[75] Inventor: Manabe Yoshiyuki, Yamato, Japan

[73] Assignee: International Business Machines Corporation, Armonk, N.Y.

[\*\*] Term: 14 Years

[21] Appl. No.: 40,261

[22] Filed: May 18, 1979

[30] Foreign Application Priority Data

Nov. 24, 1978 [JP] Japan ..... 53-49557

[51] Int. Cl. .... D14-02

[52] U.S. Cl. .... D14/113

[58] Field of Search ..... D14/40-50; 364/900; 340/700, 711, 720, 748, 750, 760

[56] References Cited

U.S. PATENT DOCUMENTS

D. 244,034 4/1977 Jenkins ..... D14/43

D. 245,025 7/1977 Smith et al. .... D14/43

D. 250,020 10/1978 Pycha ..... D14/43

OTHER PUBLICATIONS

Datamation, 9-1977, p. 33, Display Terminal.

Primary Examiner—Susan J. Lucas

Attorney, Agent, or Firm—Frederick D. Poag

[57] CLAIM

The ornamental design for a computer display, substantially as shown and described.

DESCRIPTION

FIG. 1 is a front view of the computer display showing my new design,

FIG. 2 is a rear view of the computer display of FIG. 1.

FIG. 3 is a top view of the computer display of FIGS. 1 and 2.

FIG. 4 is a bottom view of the computer display of FIGS. 1-3.

FIG. 5 is a side view of the computer display of FIGS. 1-4.

FIG. 6 is a cross-sectional view taken on line 6-6 of FIG. 1.

FIG. 7 is a perspective view of the computer display of FIGS. 1-6 on an enlarged scale.

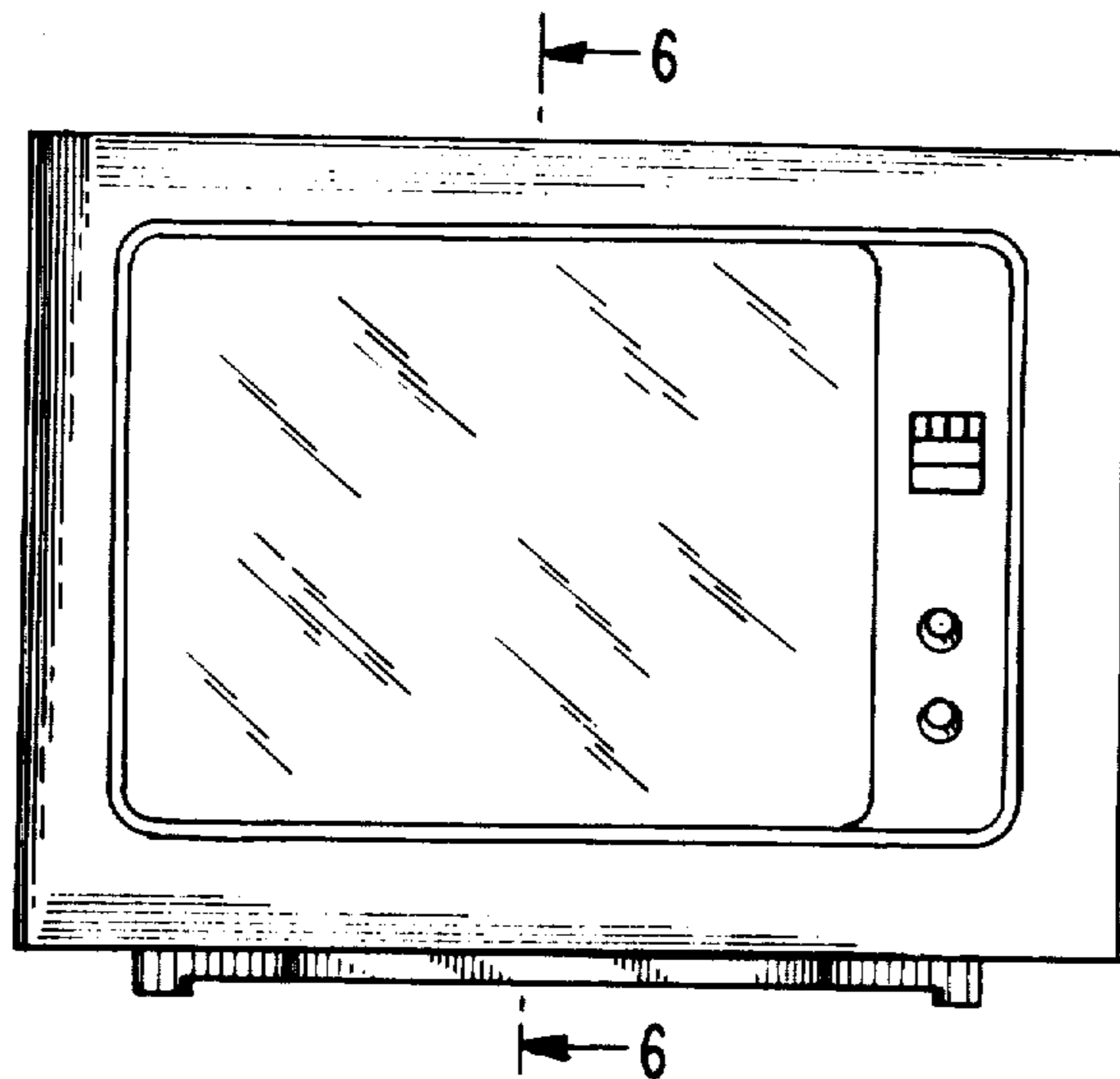

FIG. 1

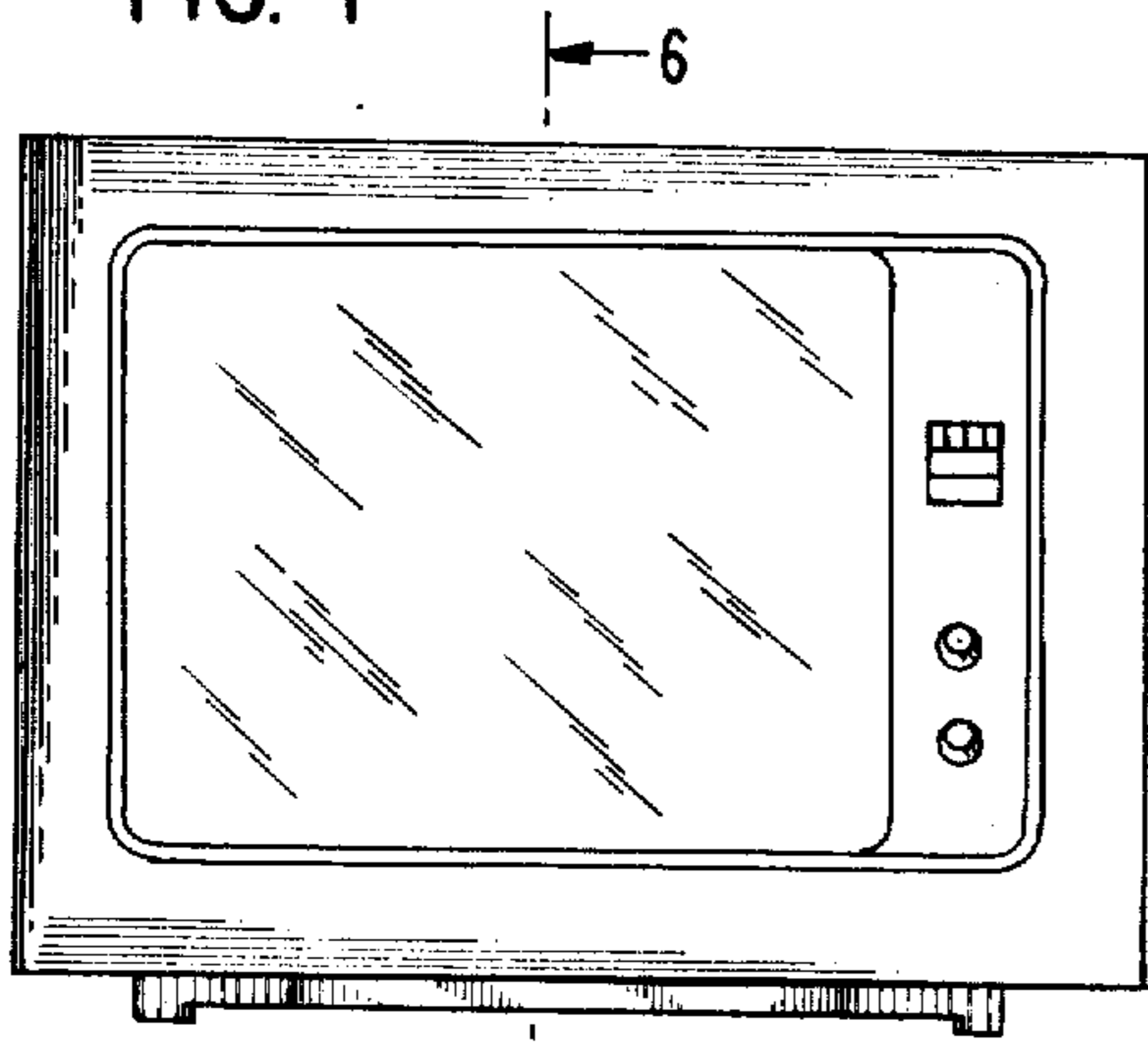

FIG. 2

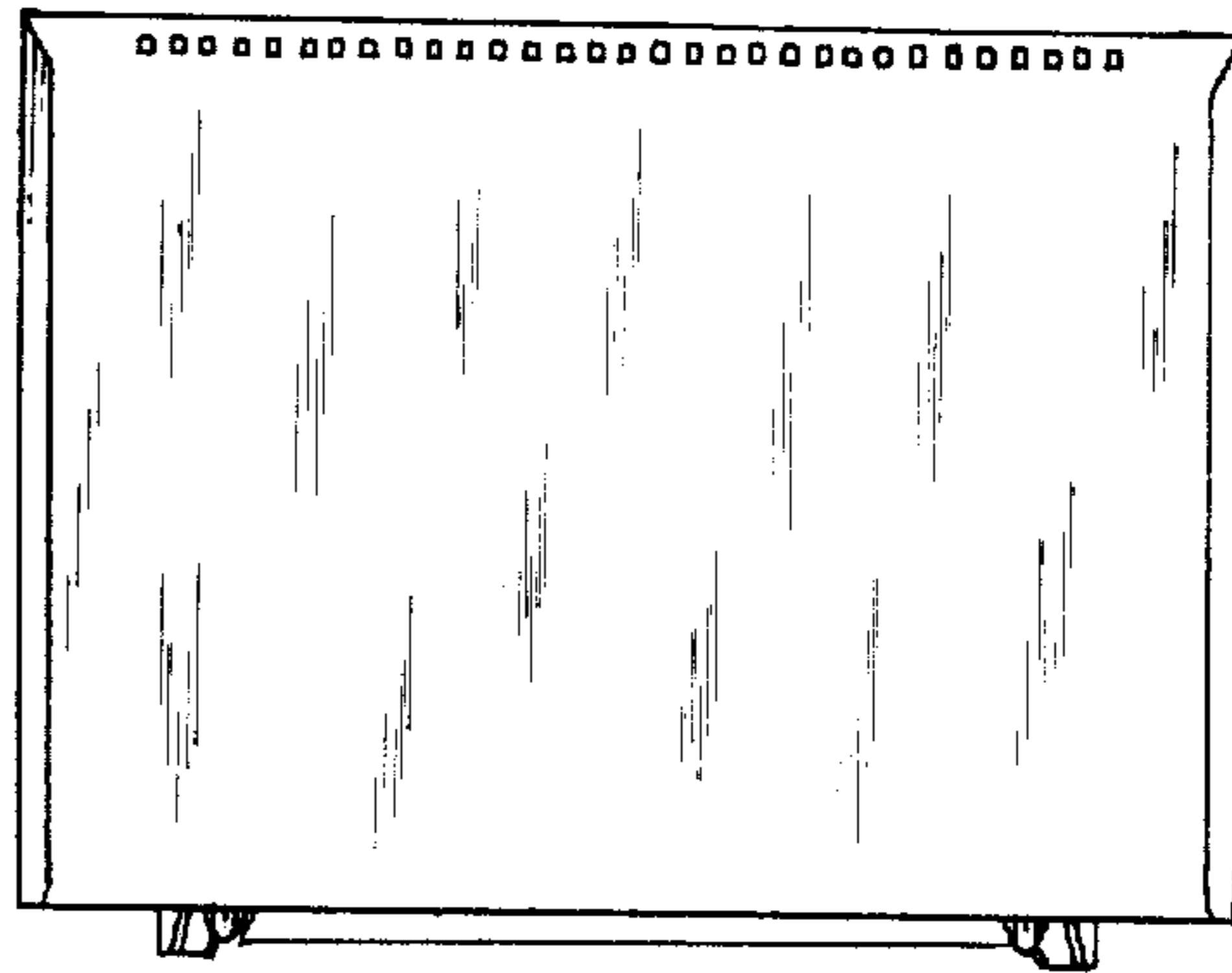

FIG. 3

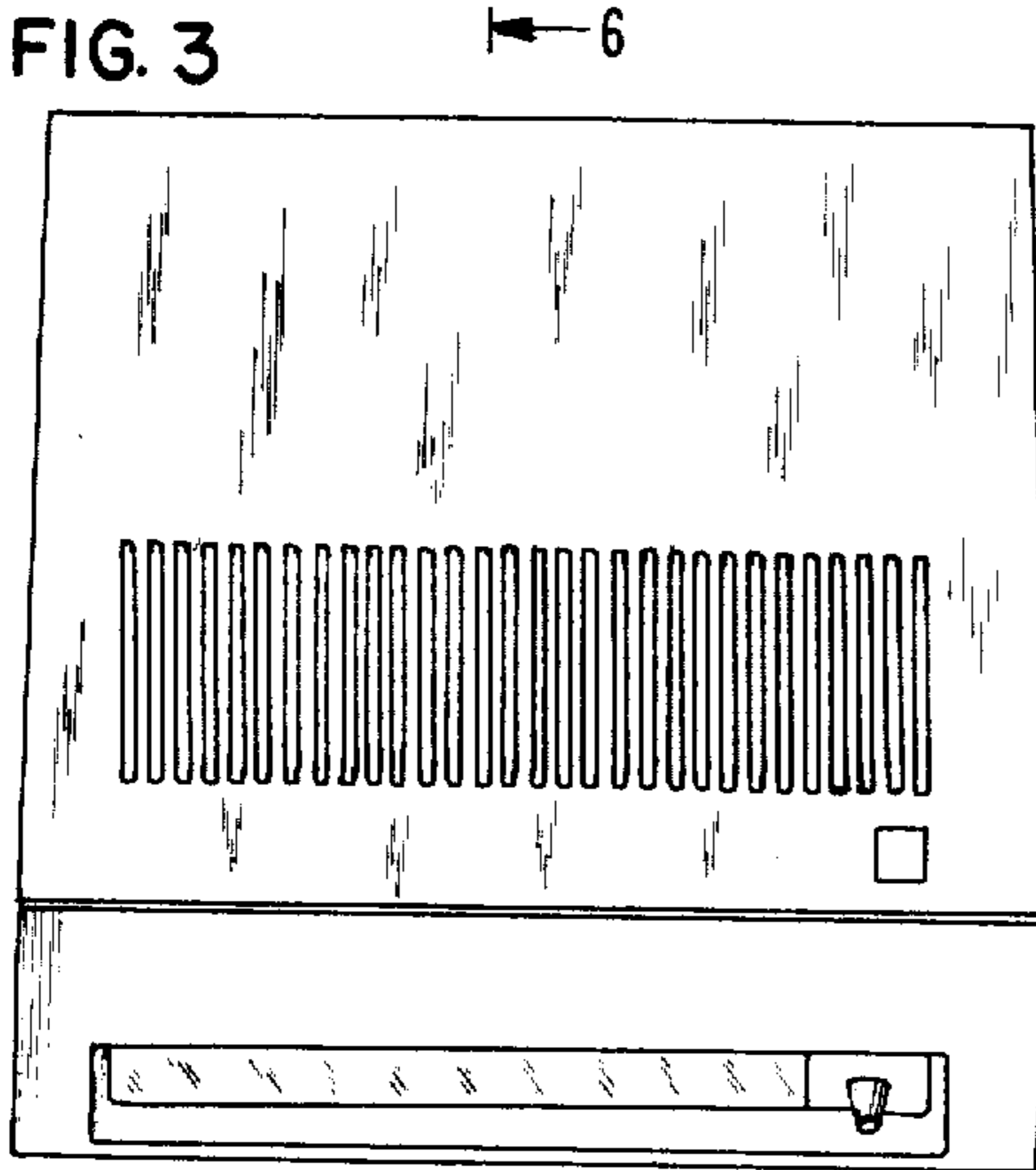

FIG. 4

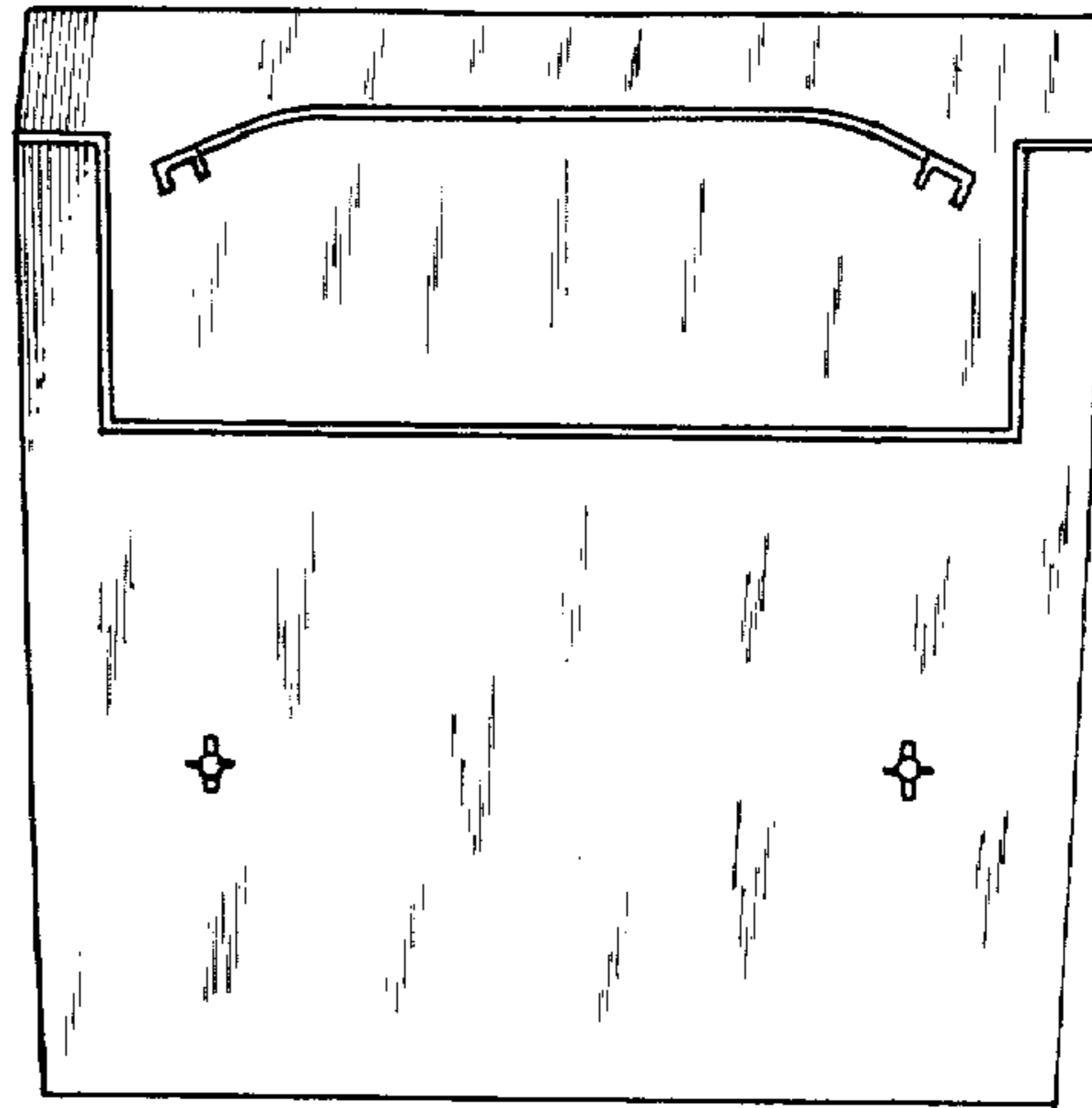

FIG. 5

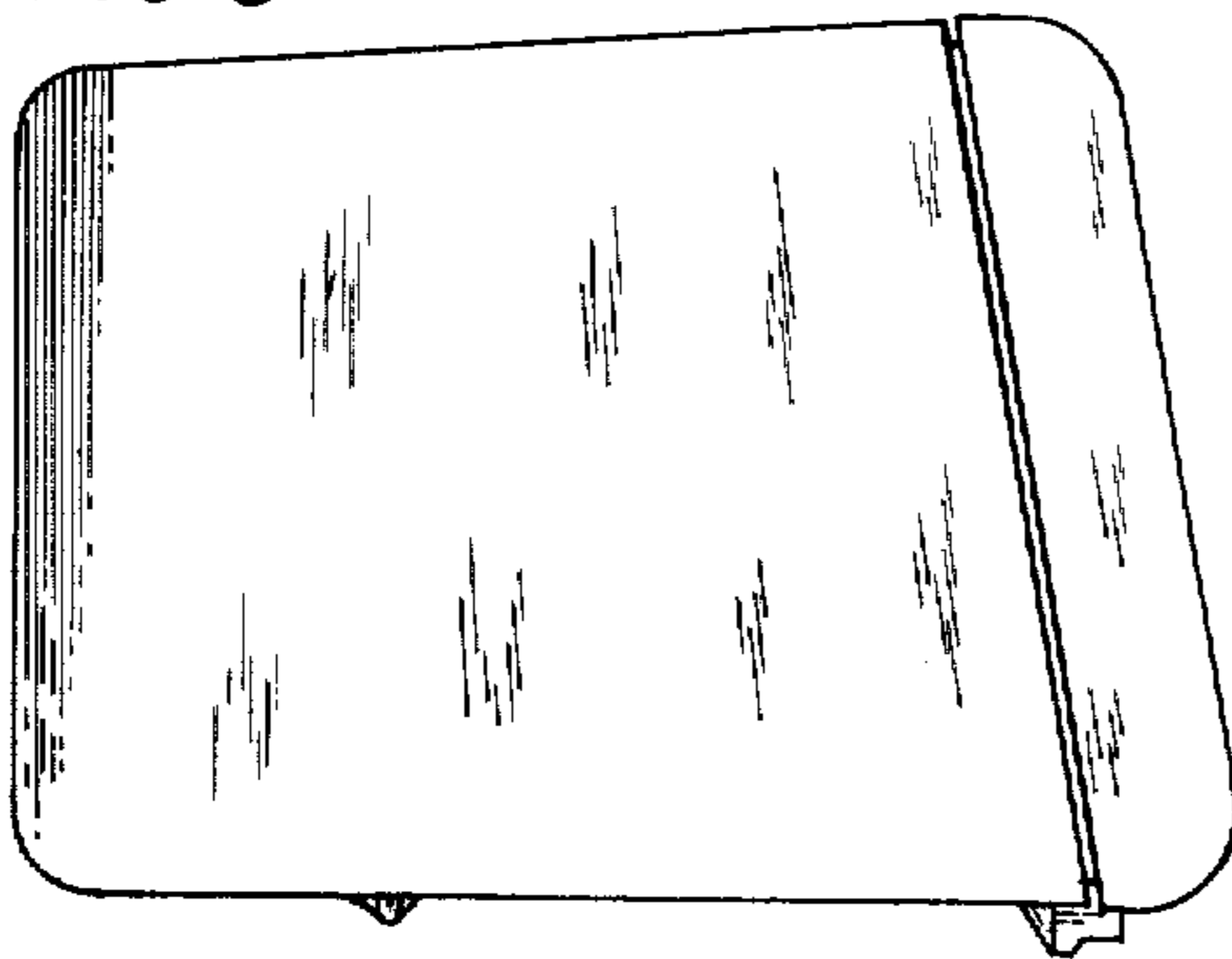

FIG. 6

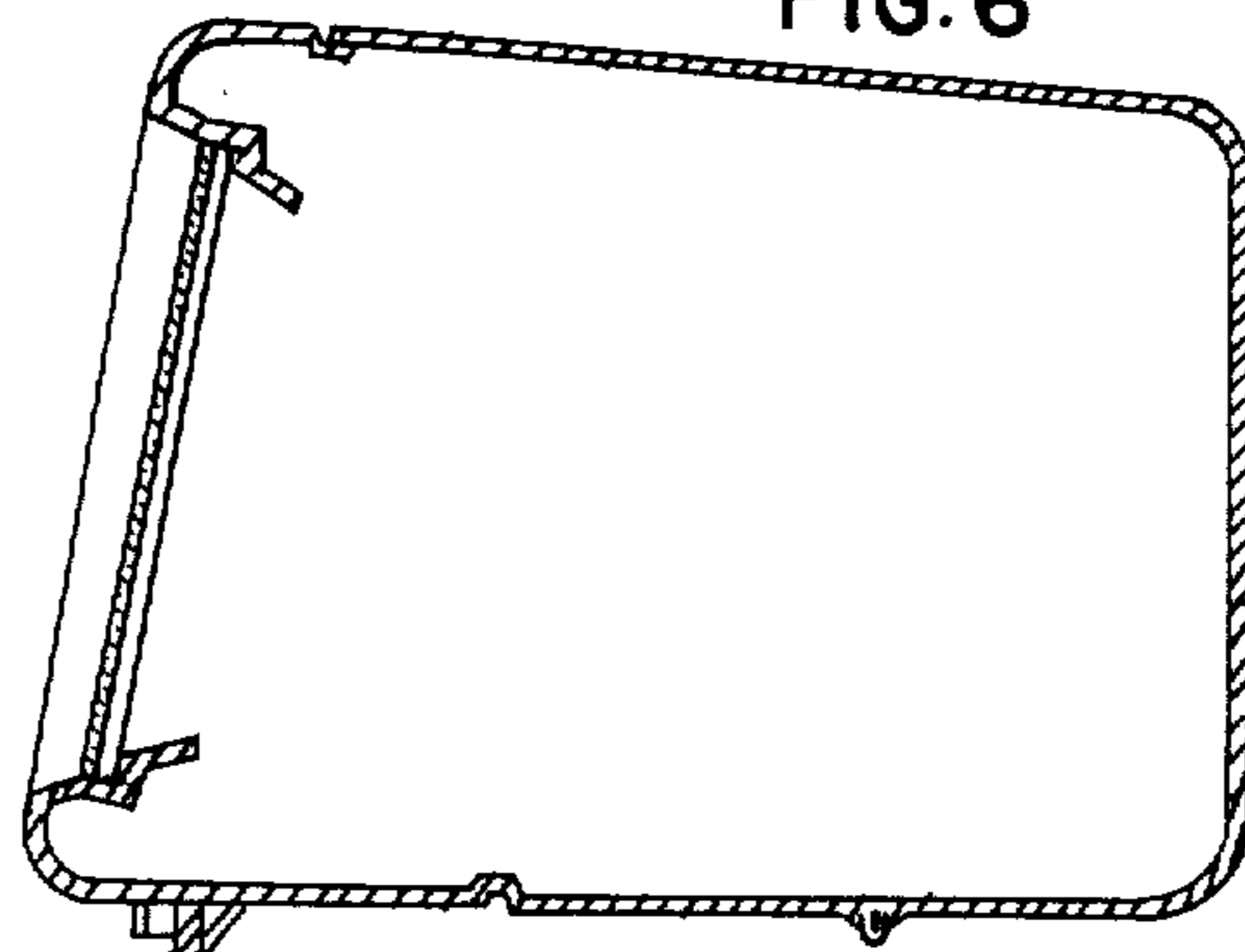

FIG. 7

