

[54] COMBINED CHANGEABLE PANEL HANDLE AND HUB HAVING LOCKING PIN AND KEY LOCK CYLINDER FOR SAFE DOORS AND THE LIKE

[75] Inventor: James P. Peppard, Nicholasville, Ky.

[73] Assignee: Sargent & Greenleaf, Inc., Nicholasville, Ky.

[**] Term: 14 Years

[21] Appl. No.: 68,326

[22] Filed: Aug. 17, 1979

[51] Int. Cl. D8-06; D8-07

[52] U.S. Cl. D8/302; D8/308

[58] Field of Search D99/28; D8/301, 302, D8/308, 331; 70/224, 207, 209, 215, 216, 221

[56] References Cited

U.S. PATENT DOCUMENTS

D. 190,562 6/1961 Schultz D8/308

OTHER PUBLICATIONS

Architectural Record, 4/62, p. 55, Lock & Handle, top of page.

Office Appliances, 6/61, p. 188, Lock & Handle, top of page.

The Corbin Cabinet Lock Line Catalog, p. 62, Handle Lock, top of page.

Primary Examiner—James M. Gandy
Attorney, Agent, or Firm—Mason, Fenwick & Lawrence

[57] CLAIM

The ornamental design for a combined changeable panel handle and hub having locking pin and key lock cylinder for safe doors and the like, as shown and described.

DESCRIPTION

FIG. 1 is a perspective view of a combined changeable panel handle and hub having locking pin and key lock cylinder for safe doors and the like embodying my new design, viewed from the front and above;

FIG. 2 is a perspective view thereof viewed from the rear and below;

FIG. 3 is a top plan view thereof;

FIG. 4 is a rear elevation view thereof;

FIG. 5 is a side elevation view thereof;

FIG. 6 is a front elevation view thereof; and

FIG. 7 is a bottom plan view thereof.

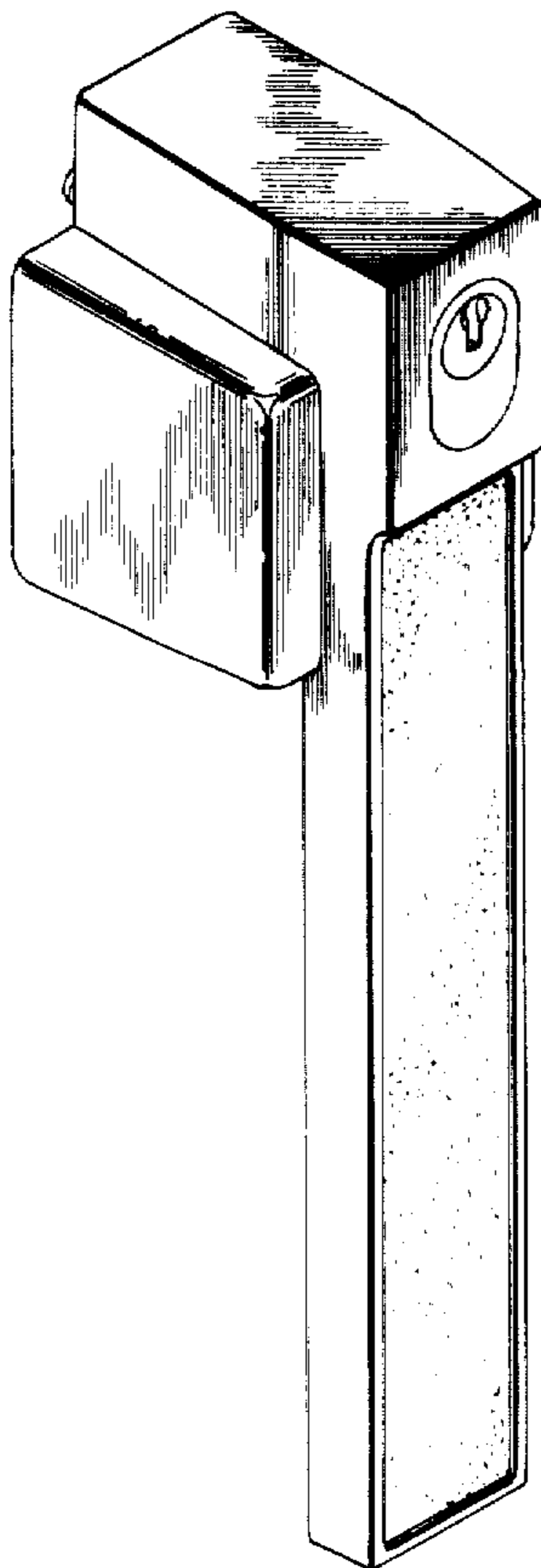

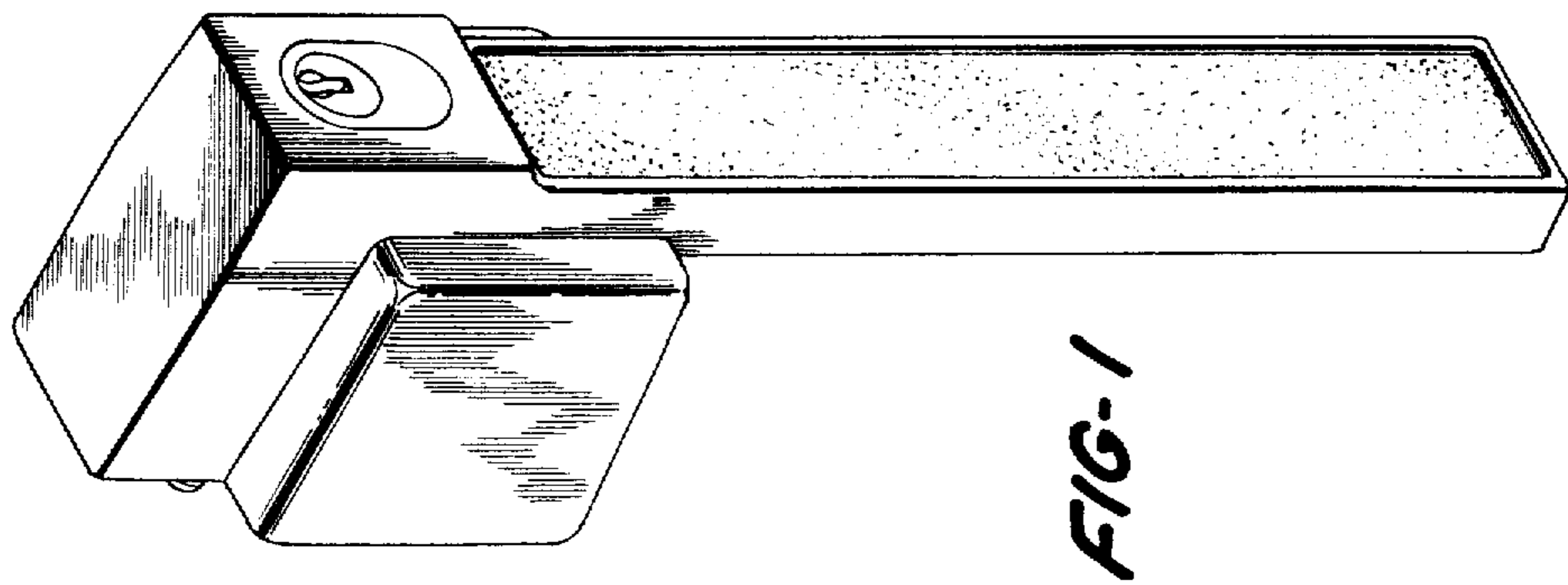

FIG-1

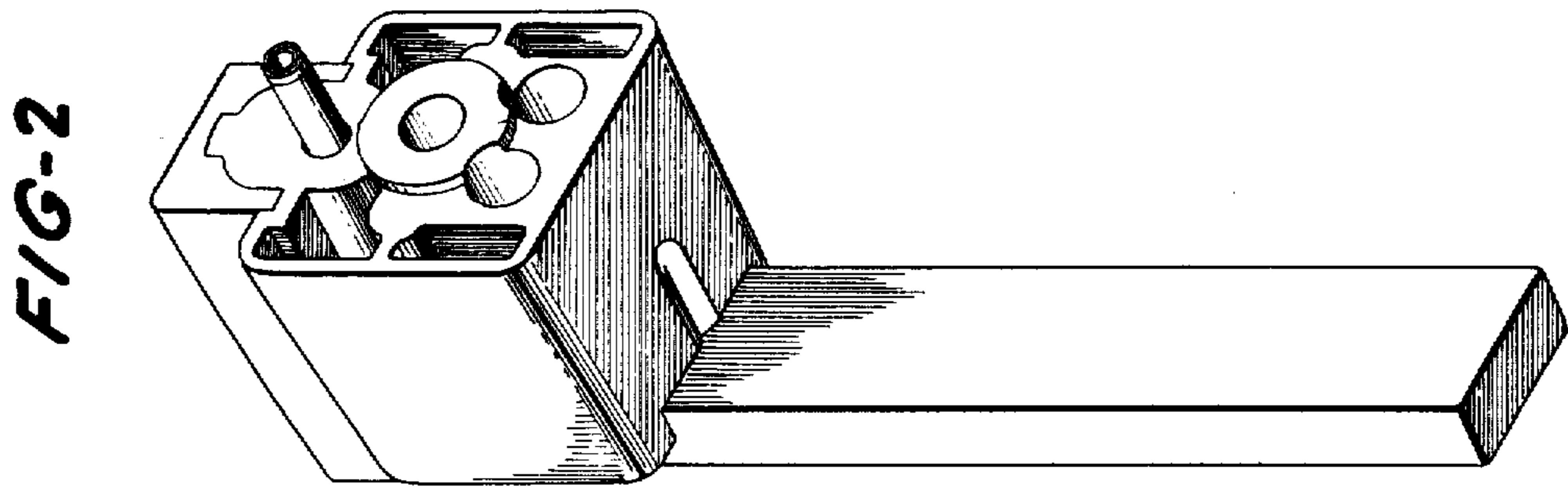

FIG-2

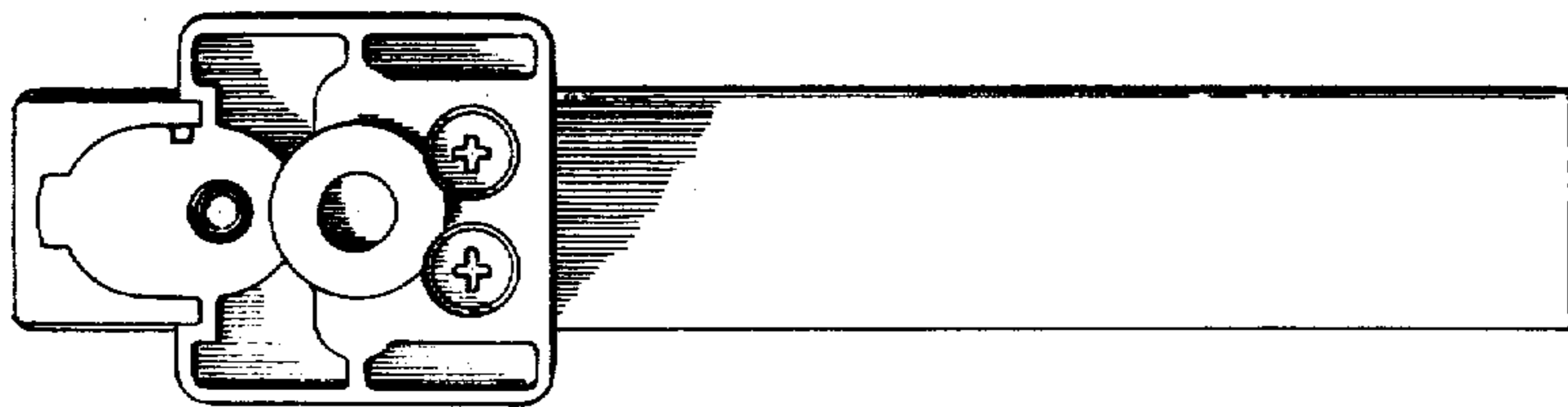

FIG-4

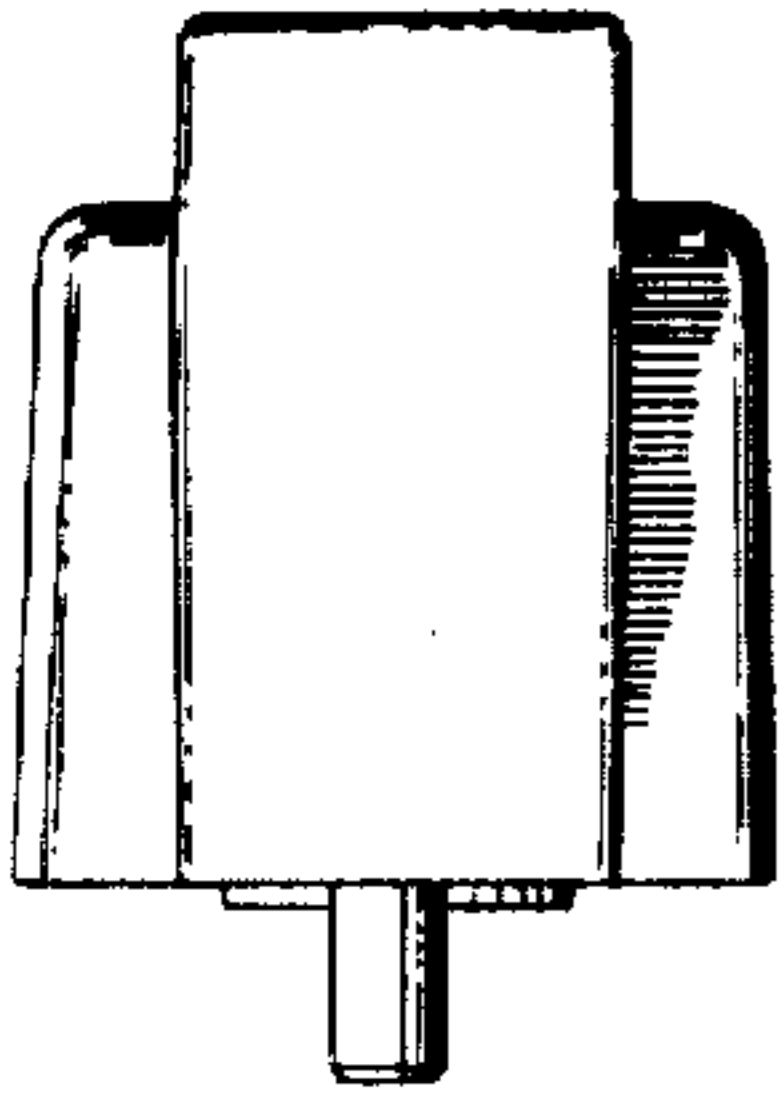

FIG-3

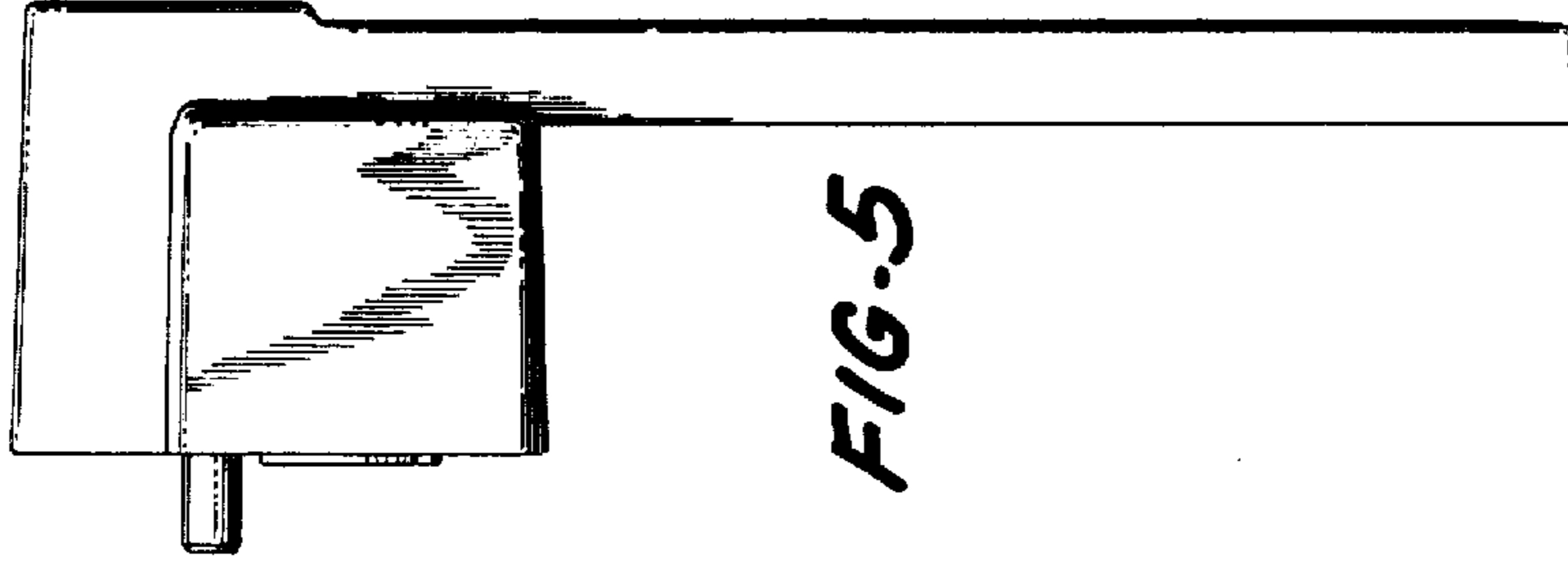

FIG-5

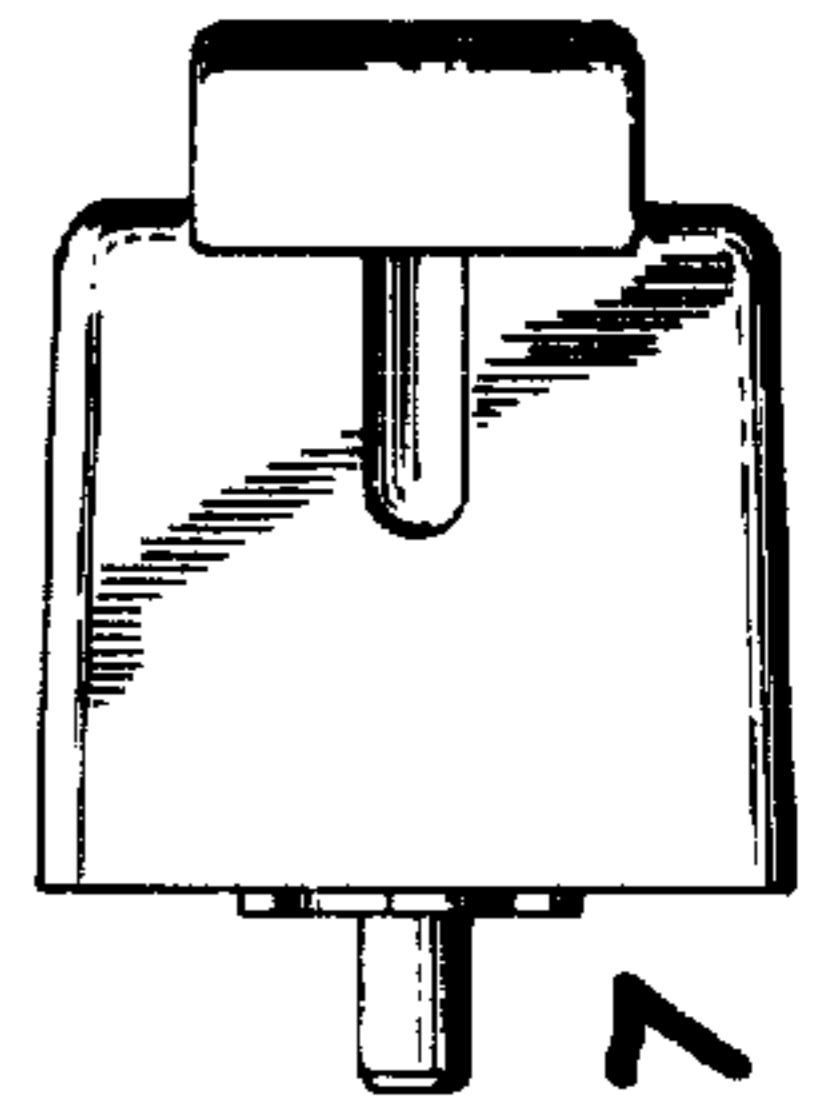

FIG-7

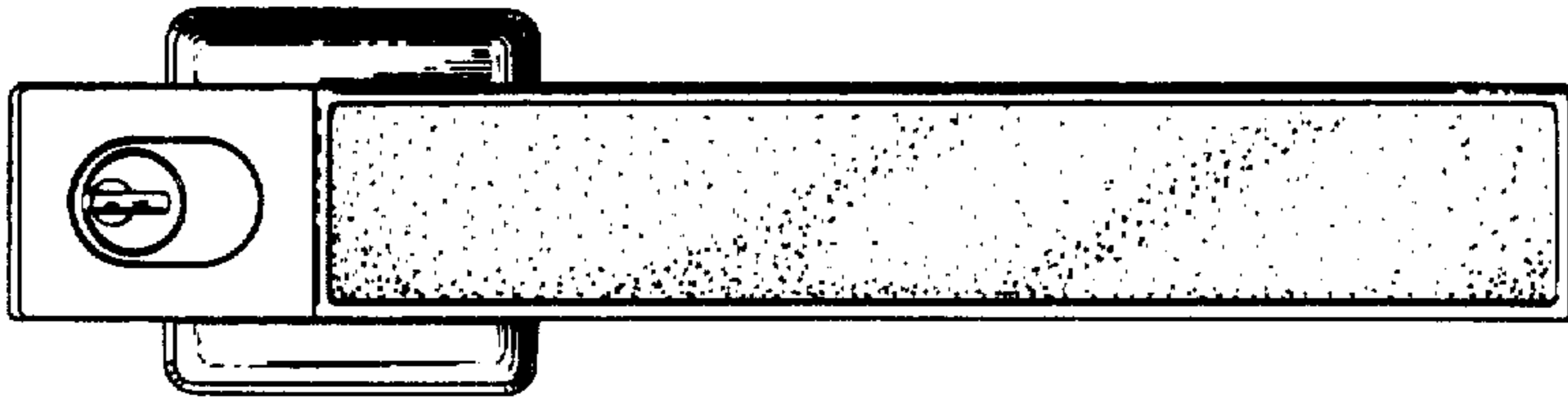

FIG-6