

[54] SWIM PADDLES FOR ARM ATTACHMENT

[76] Inventor: W. Denison Lewis, 1260 Willa Dr., Sarnia, Ontario, Canada, N7S 1T7

[\*\*] Term: 14 Years

[21] Appl. No.: 117,038

[22] Filed: Jan. 30, 1980

[51] Int. Cl. .... D21-02

[52] U.S. Cl. .... D21/239; D21/237; D21/238; 9/307; 9/301; 9/310 J

[58] Field of Search .... D21/239, 237, 238; 9/307, 301, 310 J

[56] References Cited

U.S. PATENT DOCUMENTS

- 1,140,107 5/1915 Brown ..... 9/307
- 1,529,466 3/1925 Curfman ..... D21/228
- 1,548,054 8/1925 Meadows ..... 9/307

- 1,715,571 6/1929 Robertson ..... 9/307
- 3,097,375 7/1963 Griffith ..... 9/307

Primary Examiner—Veronica O’Keefe  
Attorney, Agent, or Firm—William L. Fisher

[57] CLAIM

The ornamental design for swim paddles for arm attachment, as shown and described.

DESCRIPTION

FIG. 1 is a perspective view of a design for swim paddles for arm attachment showing my new design;  
 FIG. 2 is an end elevational view thereof;  
 FIG. 3 is a top plan view thereof;  
 FIG. 4 is a bottom plan view thereof;  
 FIG. 5 is another end elevational view thereof;  
 FIG. 6 is another top plan view thereof;  
 FIG. 7 is another bottom plan view thereof;  
 FIGS. 5-7 show said swim paddles in its power stroke position;

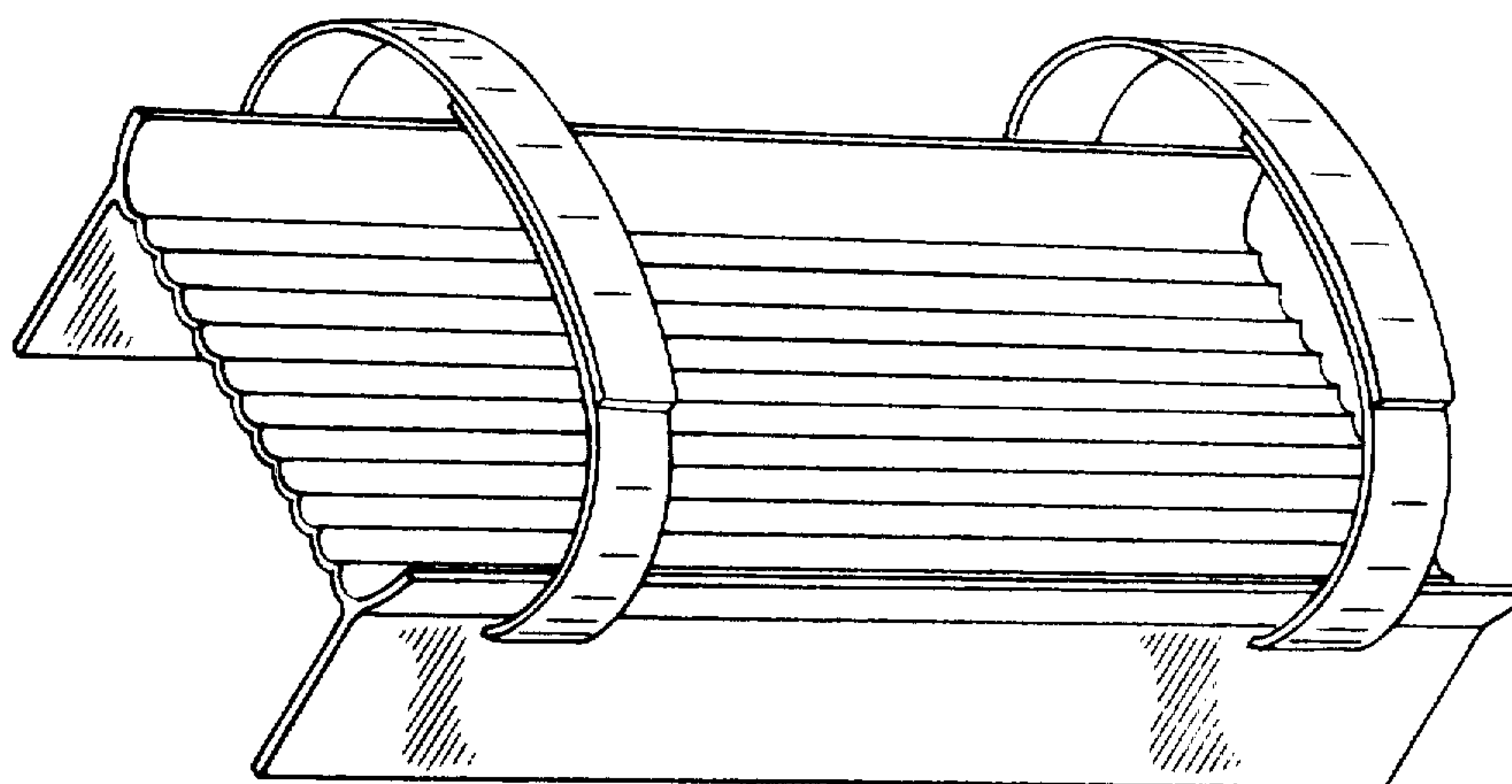

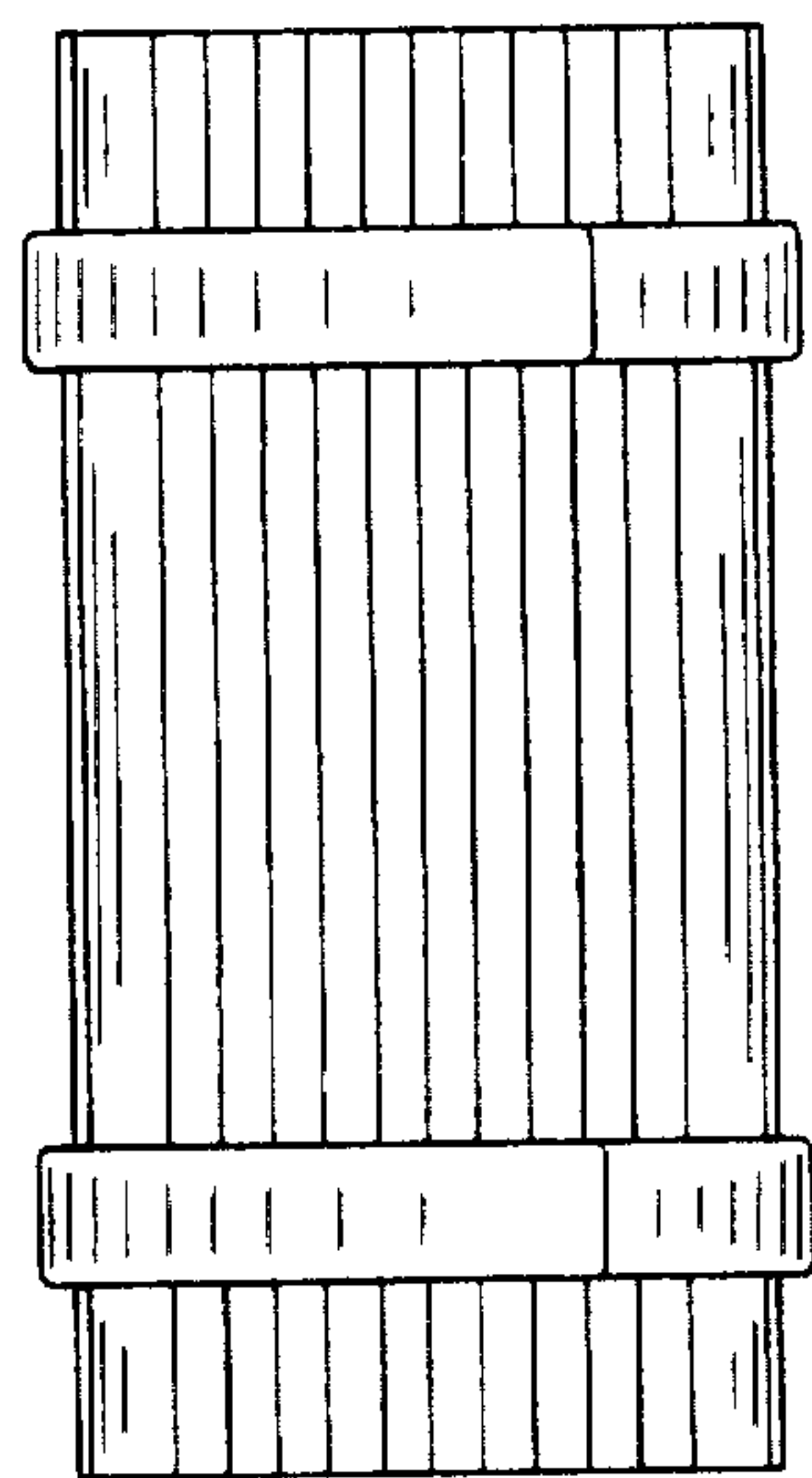
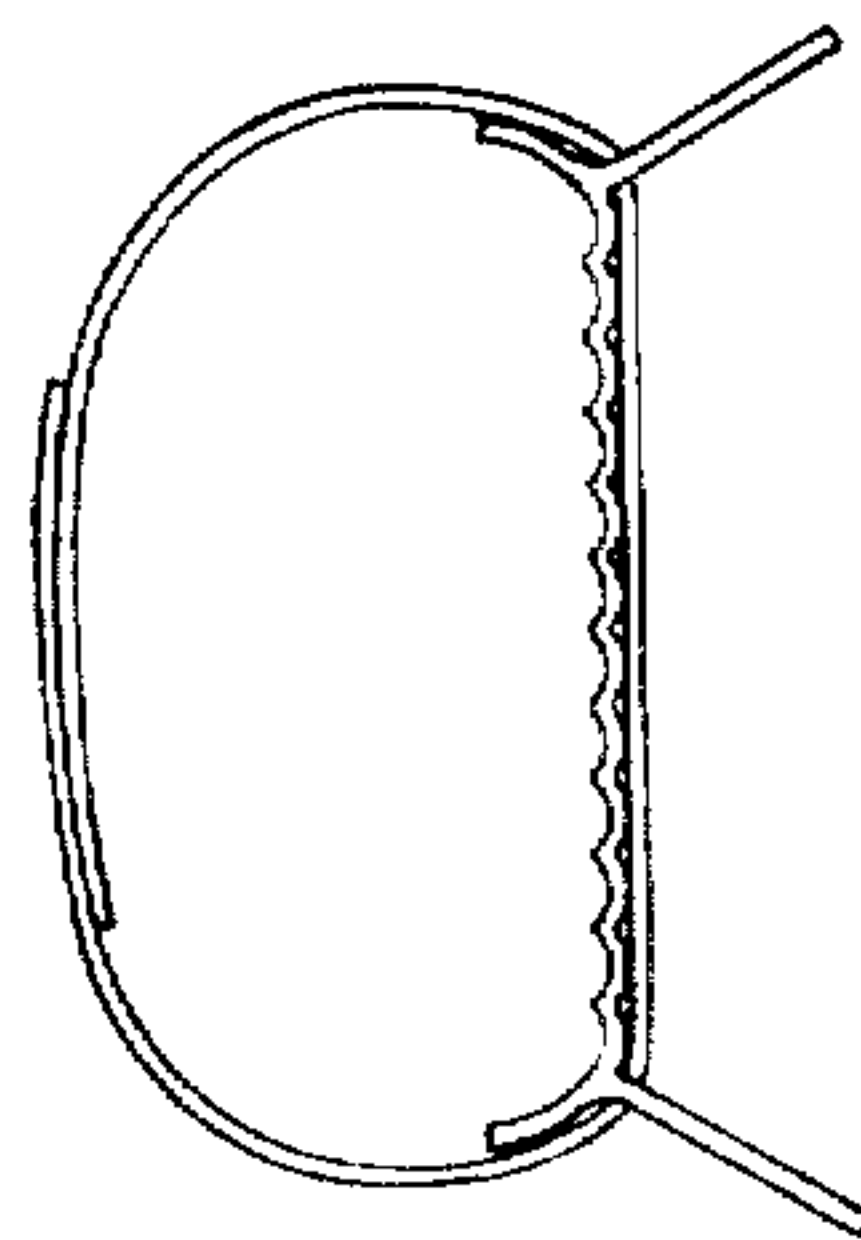
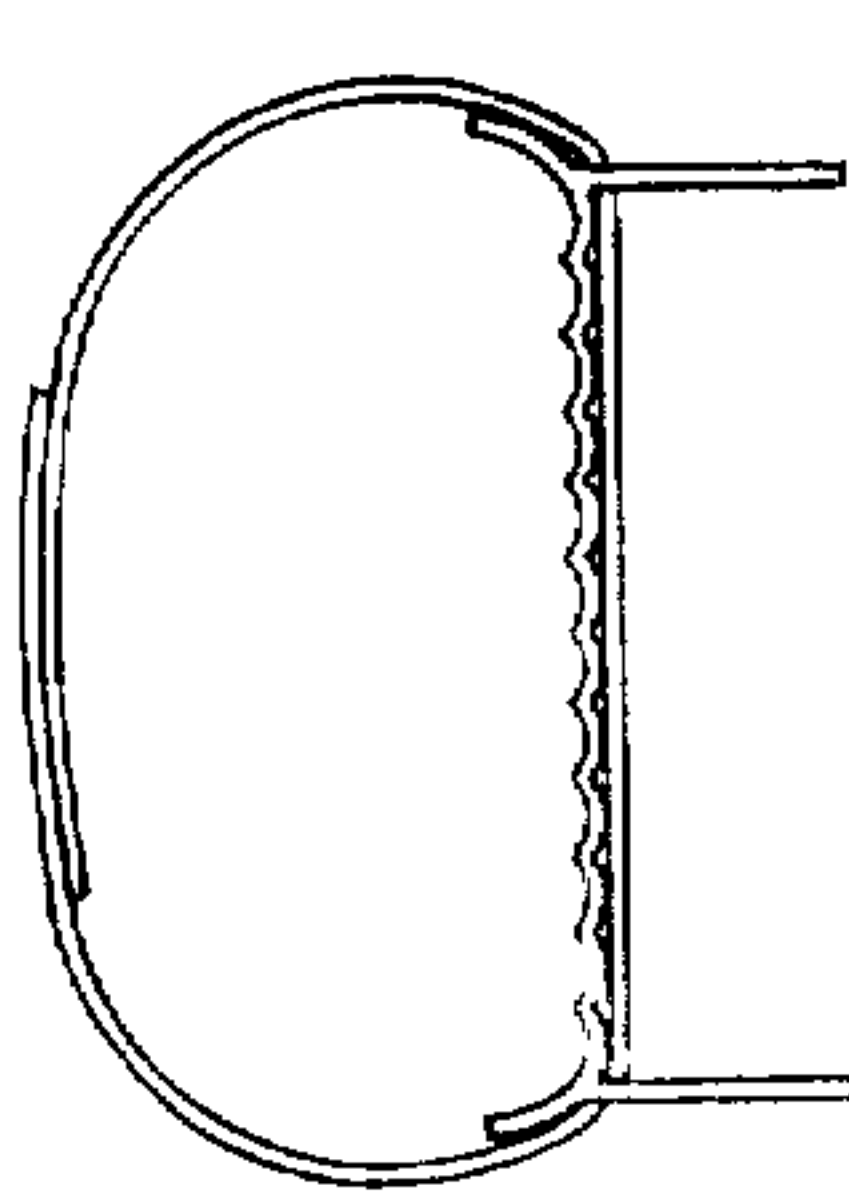
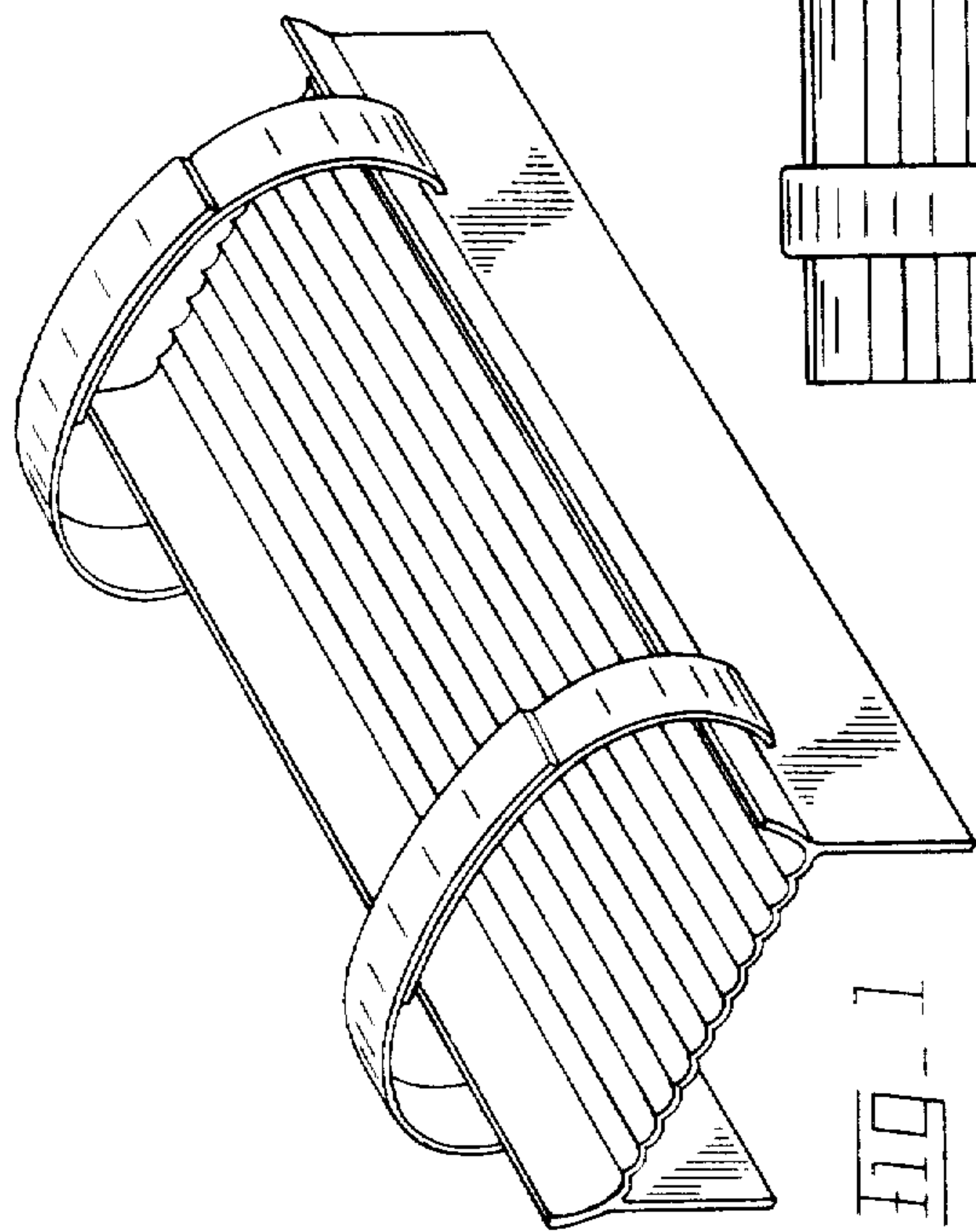

FIG. 3

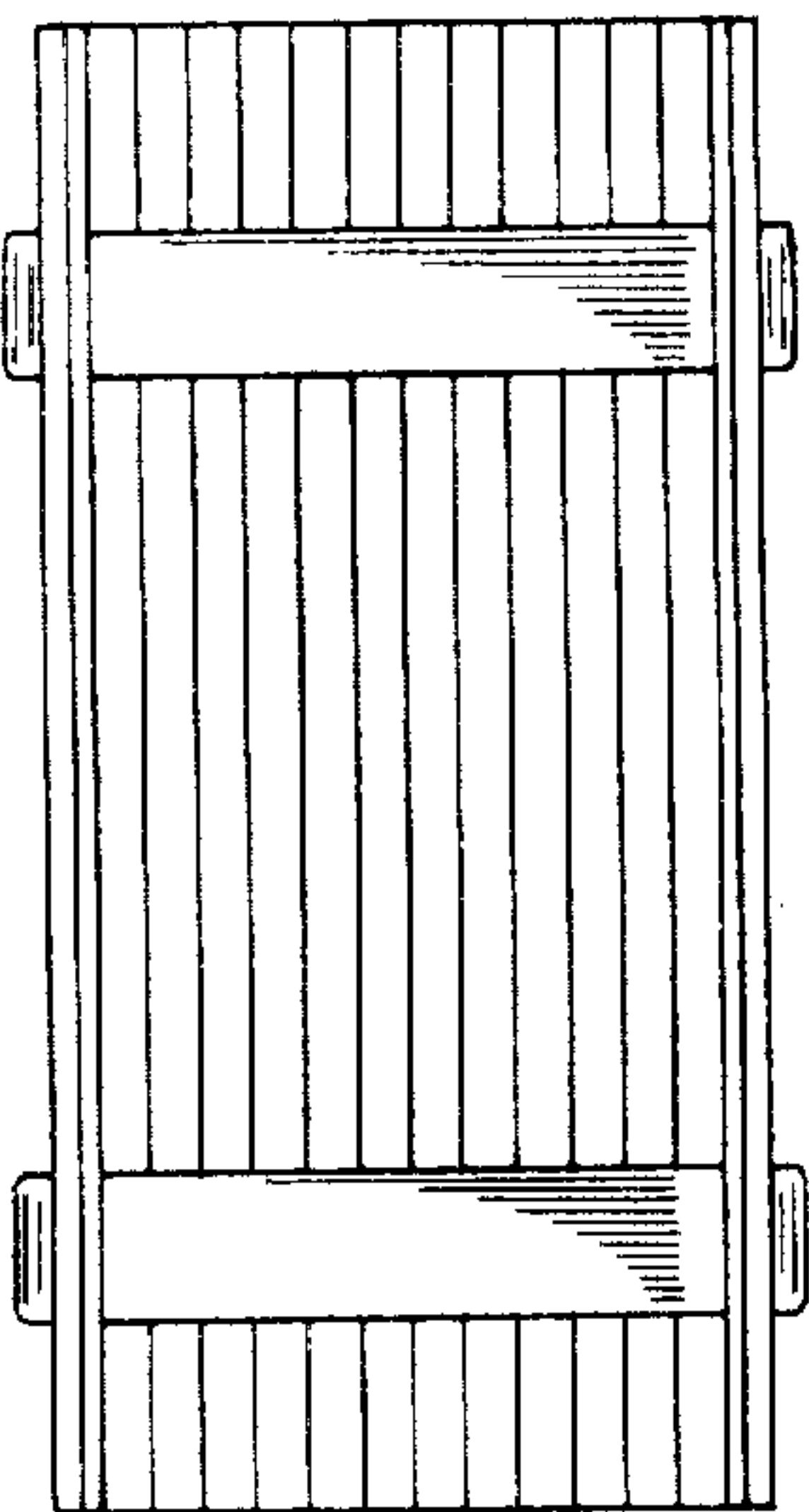

FIG. 4

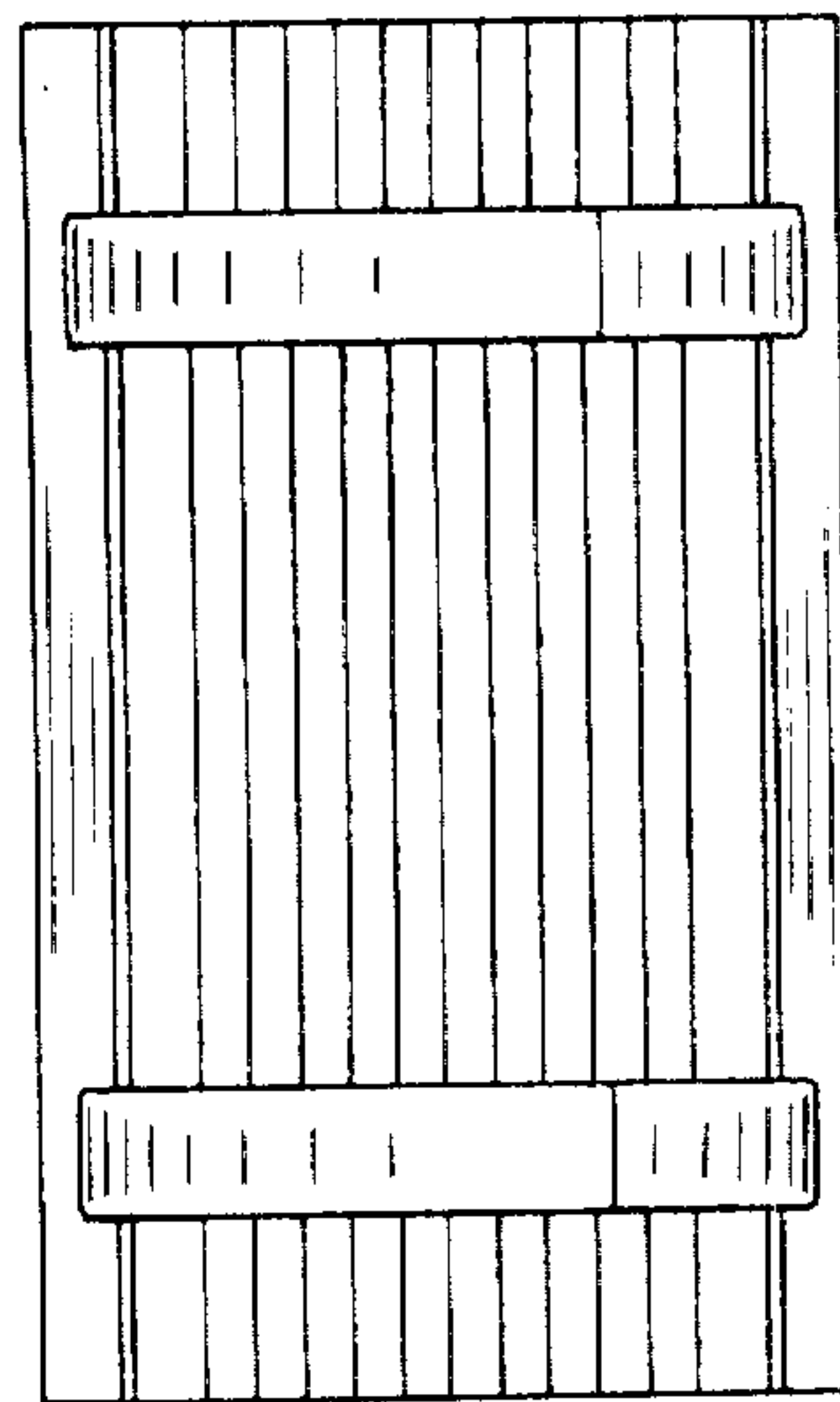

FIG. 6

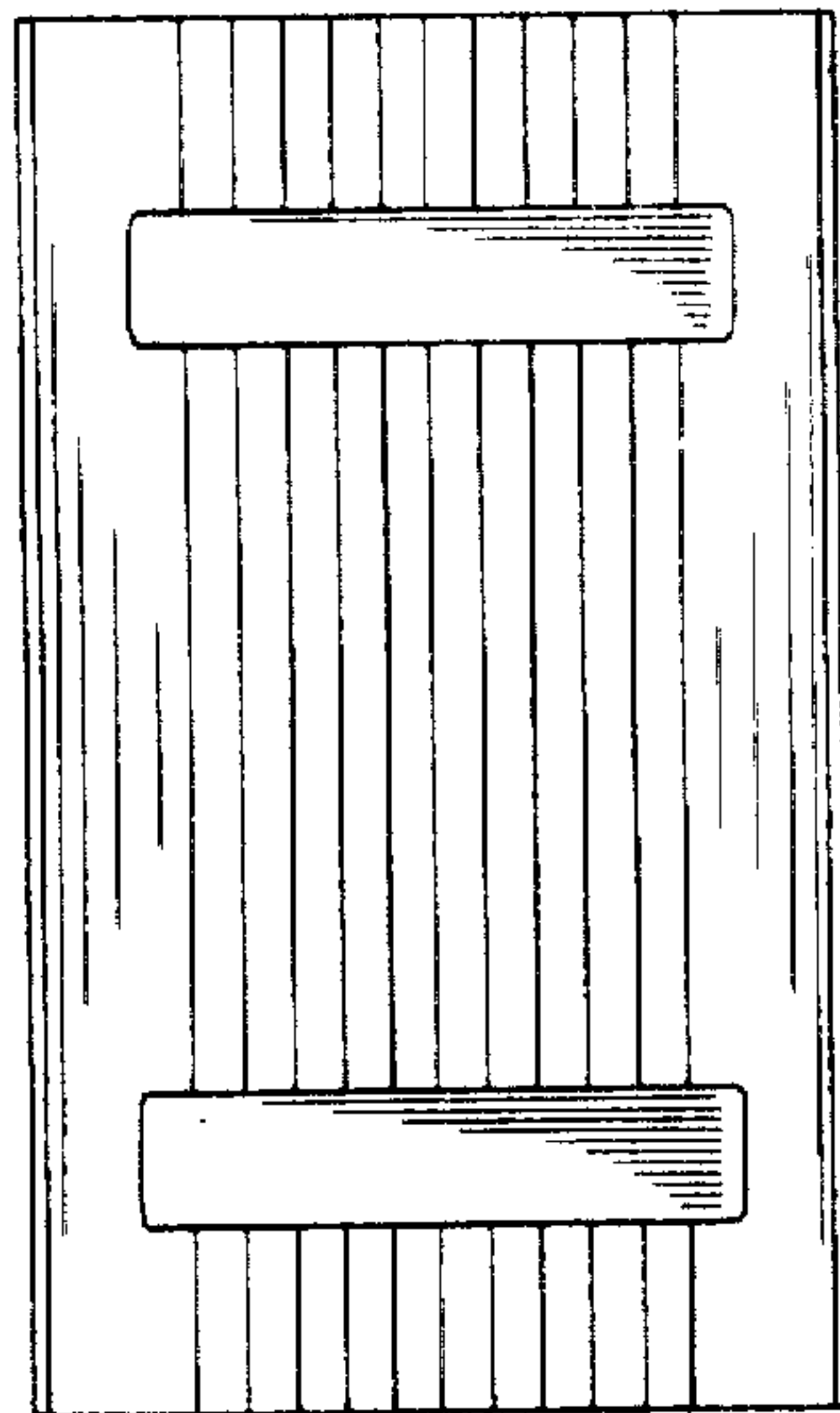

FIG. 7