

[54] TOY SABER SAW

[75] Inventor: John R. Wildman, North Riverside, Ill.

[73] Assignee: Marvin Glass & Associates, Chicago, Ill.

[**] Term: 14 Years

[21] Appl. No.: 119,809

[22] Filed: Feb. 8, 1980

[51] Int. Cl. D21-01

[52] U.S. Cl. D21/120; D8/64

[58] Field of Search D8/64, 61, 62, 68; 30/272 A, 273, 393; D21/120; 46/112, 39, 40, 248; 310/50, 47; 74/166; D15/132

[56]

References Cited

U.S. PATENT DOCUMENTS

- D. 191,570 10/1961 Downs D8/64
- D. 197,549 2/1964 Johnson D8/64
- 3,863,342 2/1975 Griffies et al. D8/64 X

Primary Examiner—A. Hugo Word
Attorney, Agent, or Firm—Mason, Kolehmainen, Rathburn & Wyss

[57]

CLAIM

The ornamental design for a toy saber saw, as shown and described.

DESCRIPTION

FIG. 1 is a left side perspective view of the toy saber saw showing my new design;
 FIG. 2 is a top plan view thereof;
 FIG. 3 is a left side elevational view thereof, the right side view being a mirror image thereof;
 FIG. 4 is a bottom plan view thereof;
 FIG. 5 is a front elevational view thereof; and
 FIG. 6 is a rear elevational view thereof.

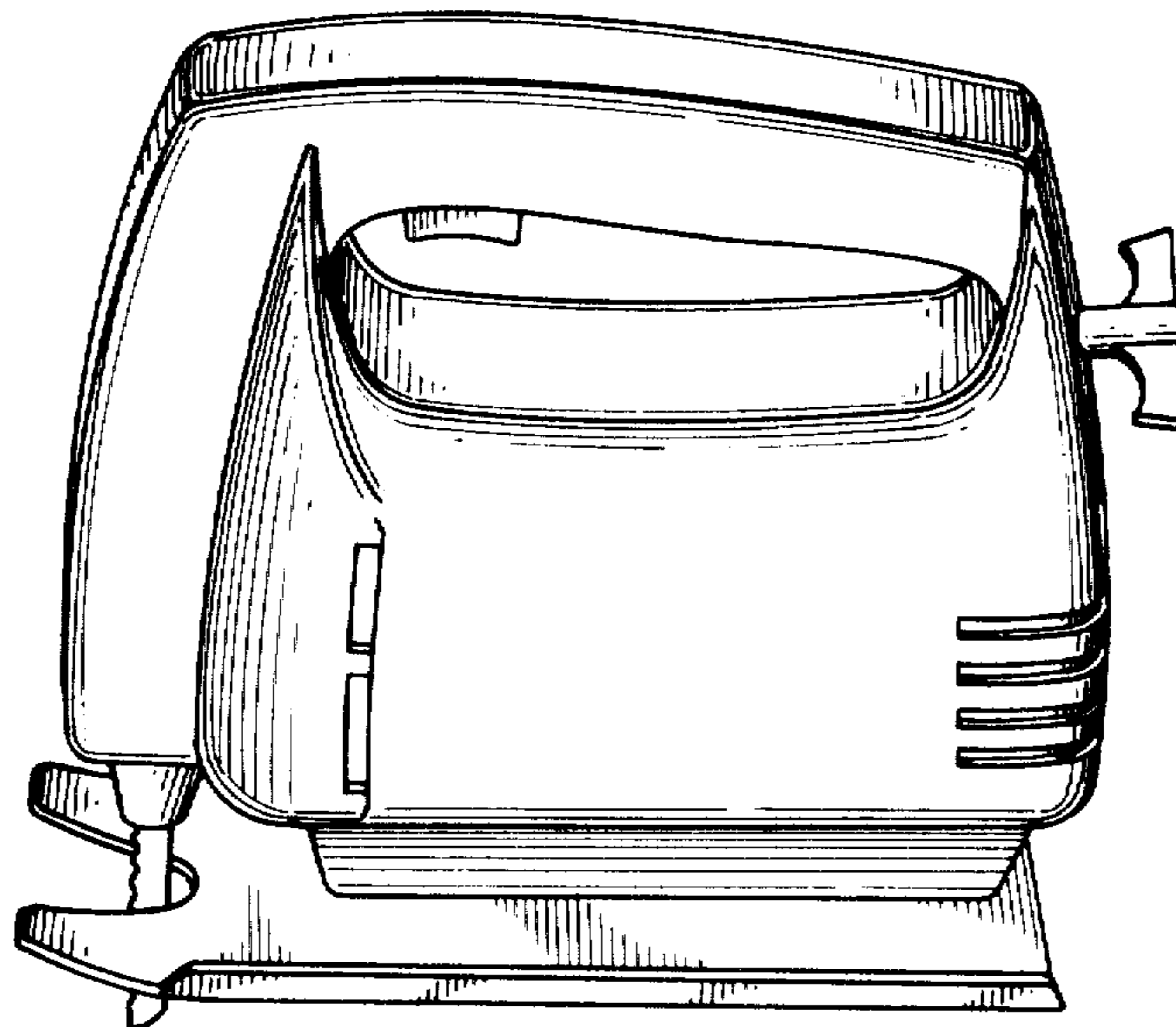

Fig 1

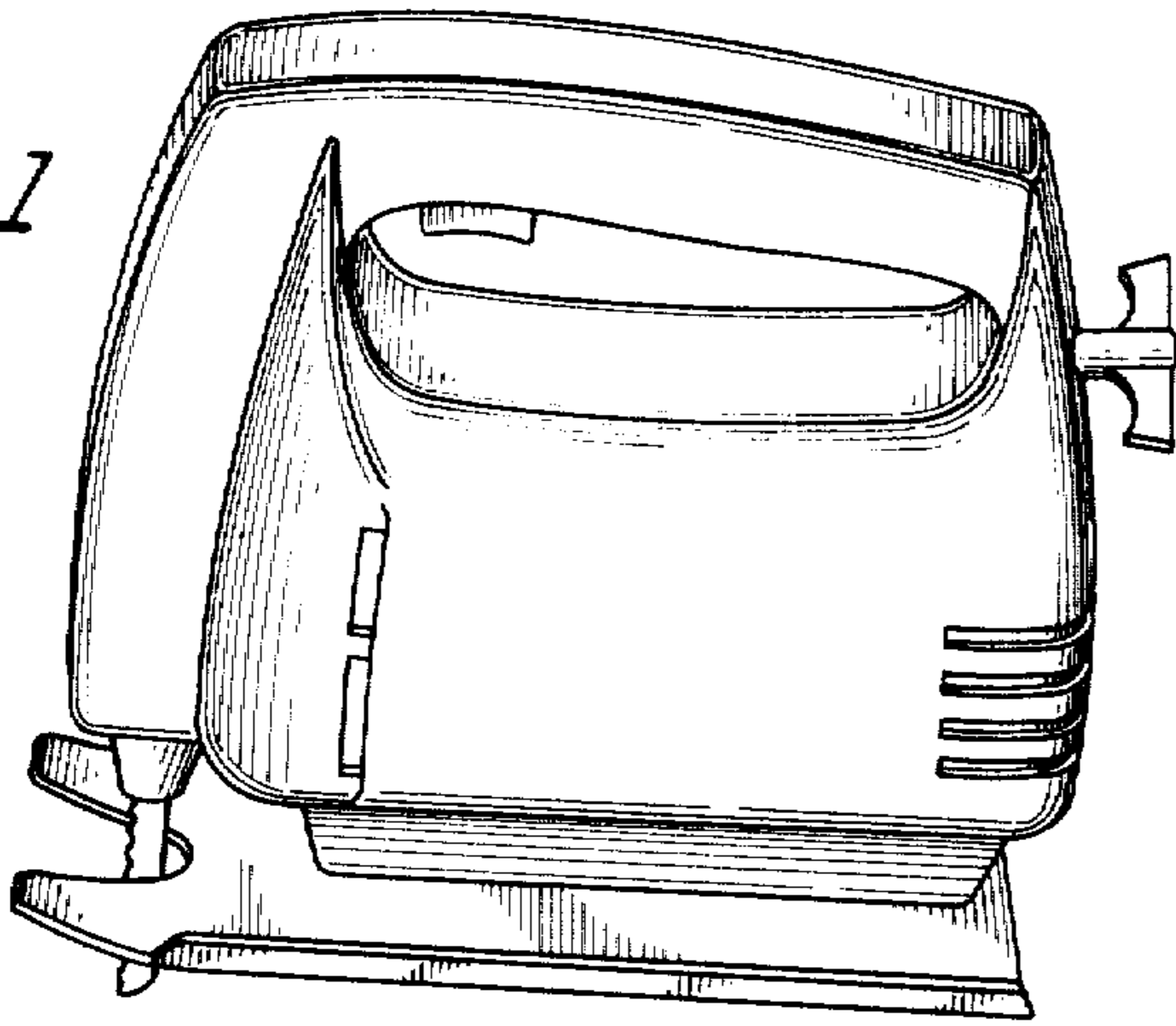

Fig 5

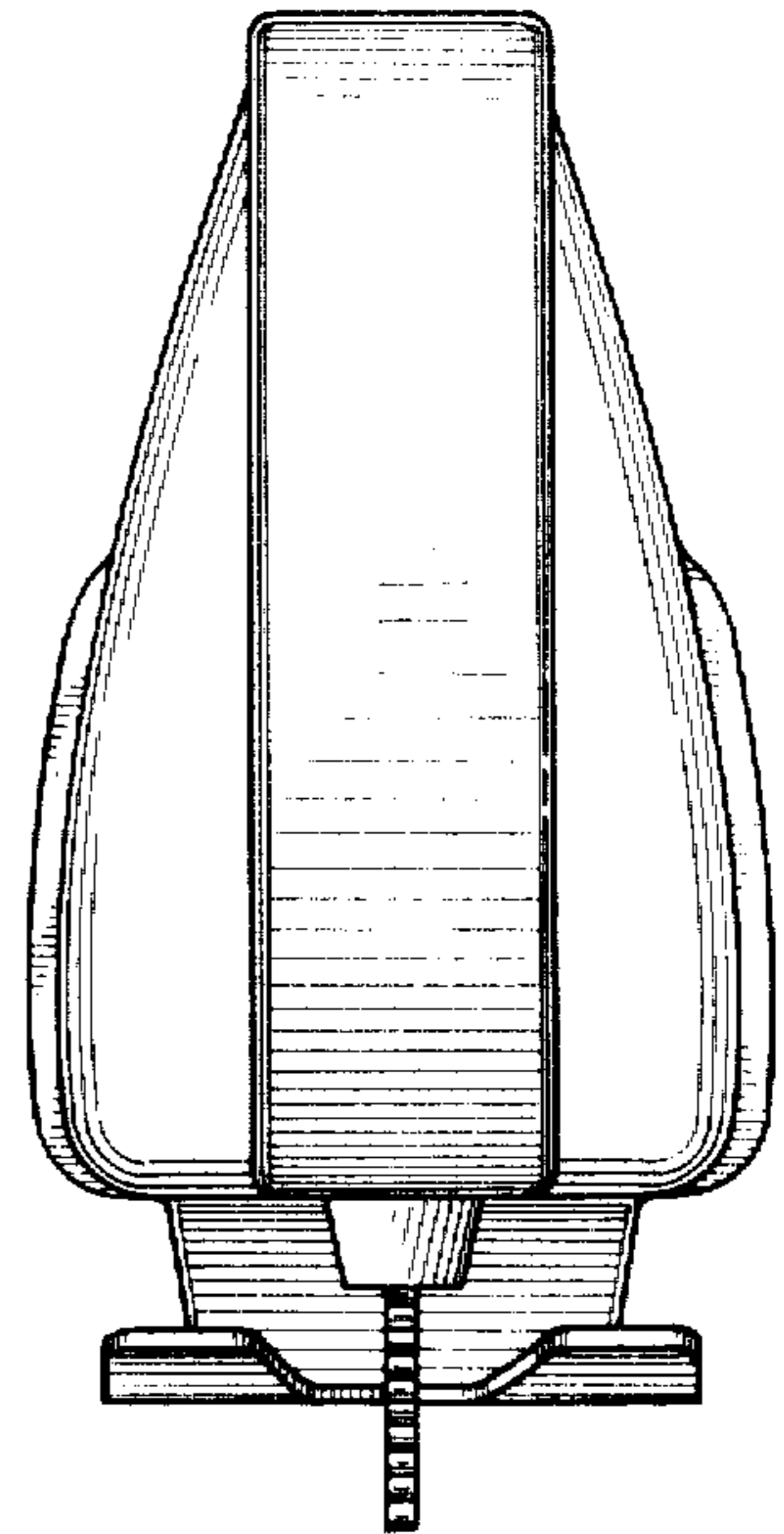

Fig 2

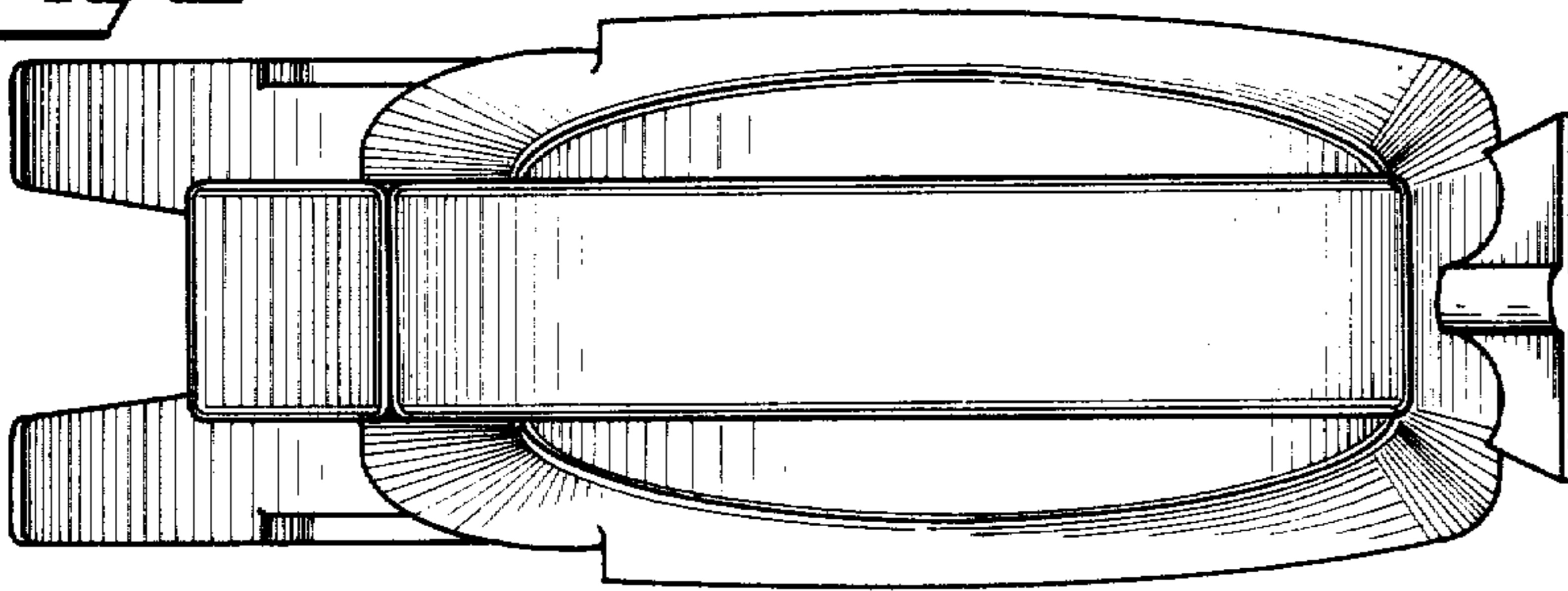

Fig 3

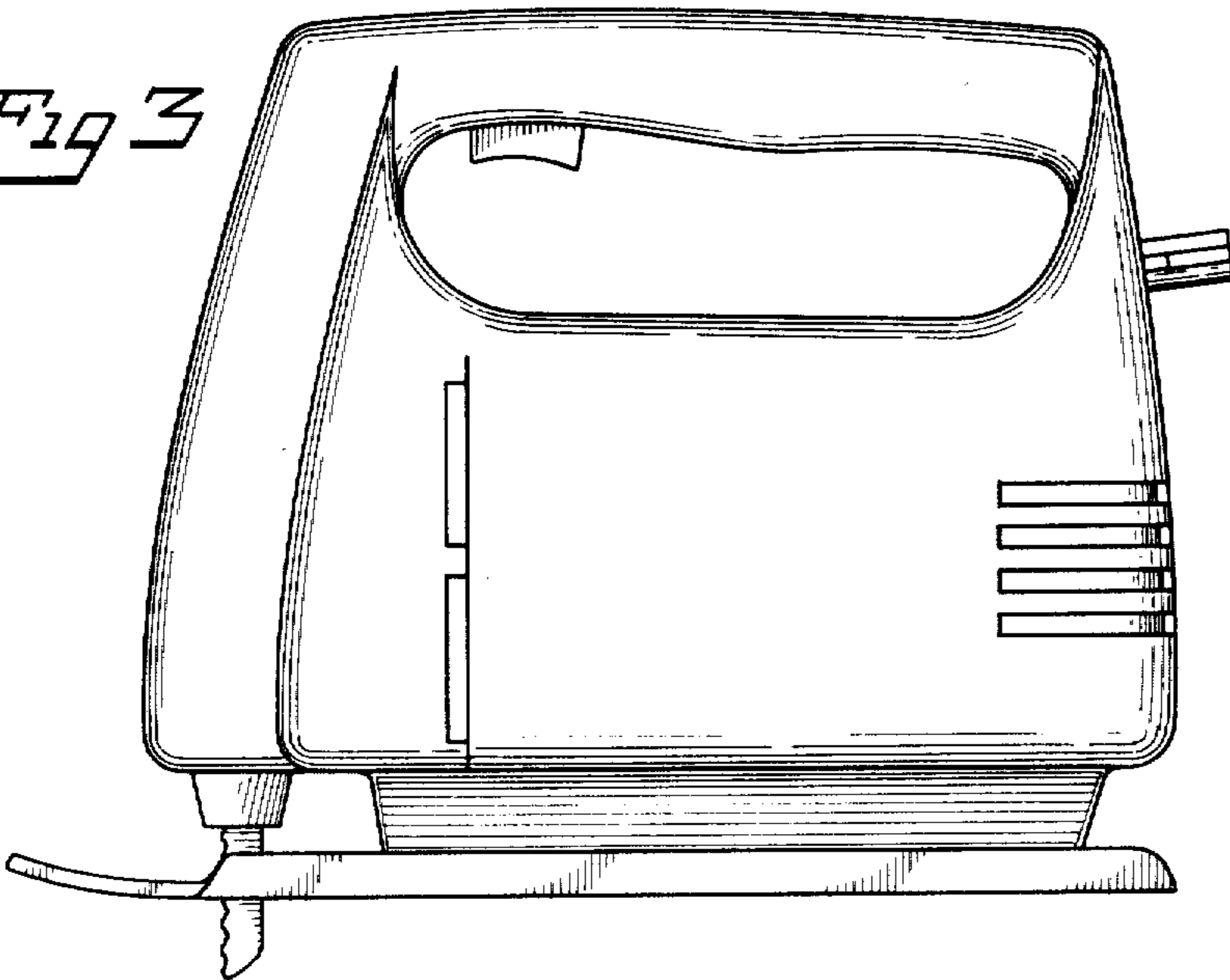

Fig 6

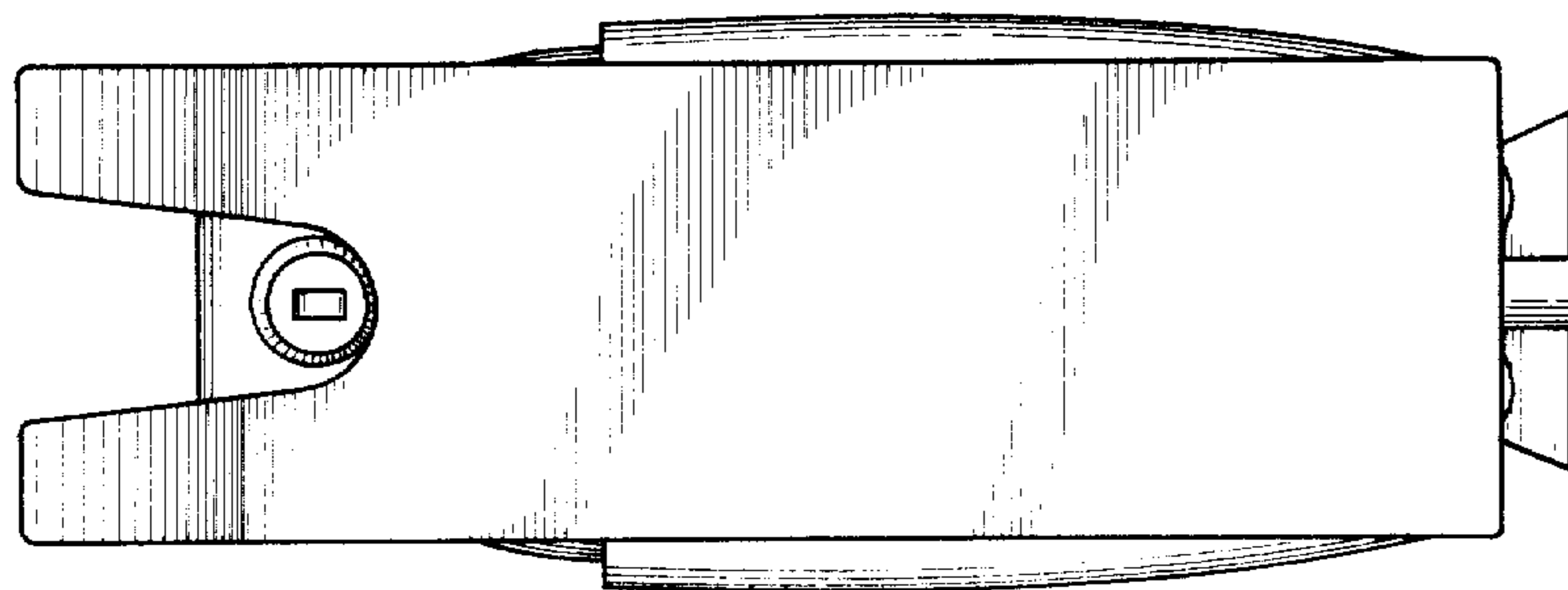
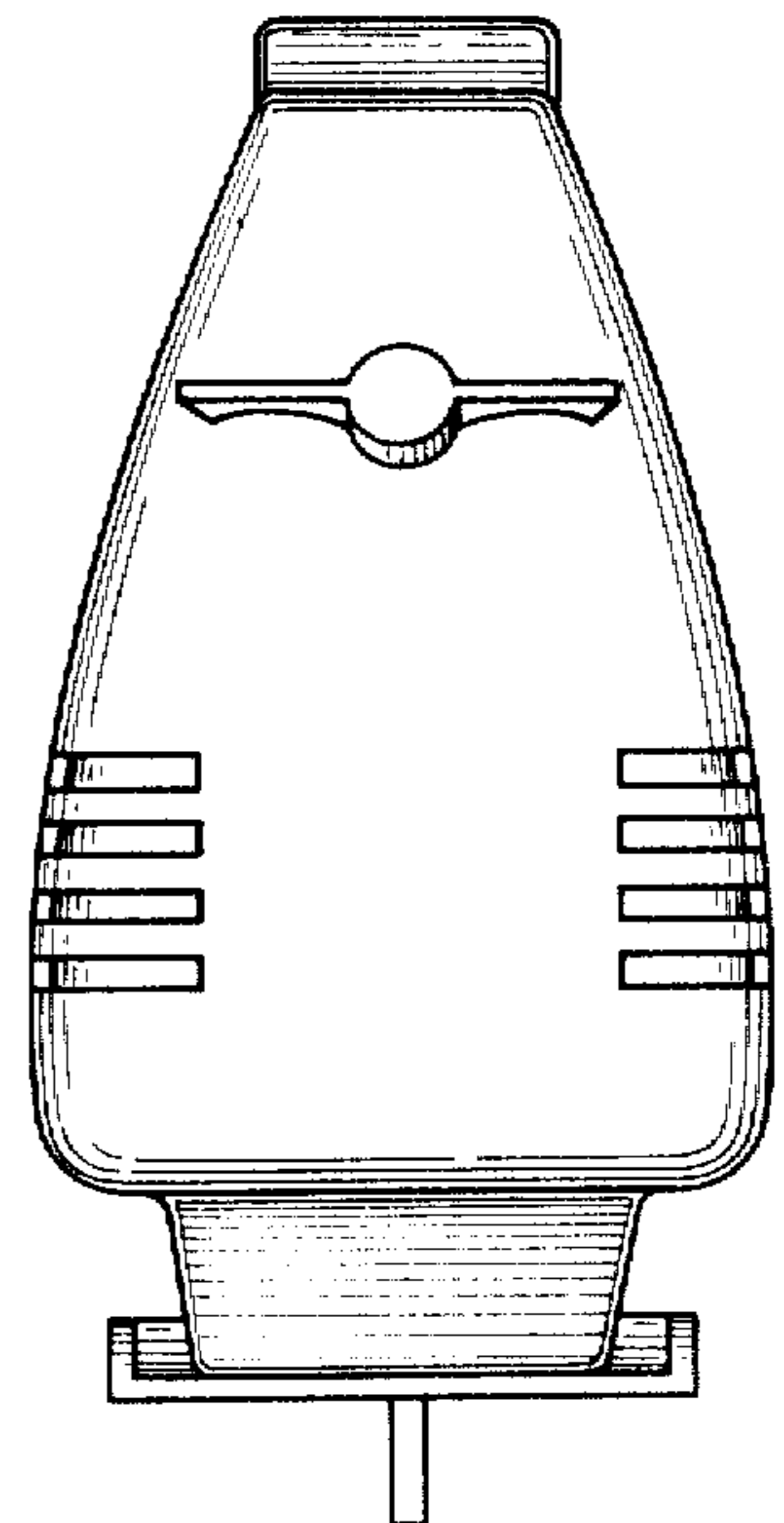

Fig 4