

[54] VEHICLE ROOF HATCH FRAME

[75] Inventor: James P. Butler, Lewisville, Tex.

[73] Assignee: Affiliated Hatch and Sunroof, Inc., Dallas, Tex.

[\*\*] Term: 14 Years

[21] Appl. No.: 967,228

[22] Filed: Dec. 7, 1978

[51] Int. Cl. .... D12-16

[52] U.S. Cl. .... D12/156

[58] Field of Search ..... D12/156, 183; 296/210, 296/212, 213, 215, 217, 218, 221; 98/2.14

[56] References Cited

U.S. PATENT DOCUMENTS

- D. 235,536 6/1975 Boston, Jr. .... D12/183
- 2,556,062 6/1951 Buehrig ..... 296/218
- 4,121,870 10/1978 Oakey ..... 296/215

Primary Examiner—James M. Gandy

Attorney, Agent, or Firm—Hubbard, Thurman, Turner, Tucker & Glaser

[57] CLAIM

The ornamental design for a vehicle roof hatch frame, as shown and described.

DESCRIPTION

FIG. 1 is a top perspective view of a vehicle roof hatch frame showing my new design;

FIG. 2 is an enlarged bottom perspective view thereof;

FIG. 3 is a greatly enlarged top perspective view thereof taken at a different angle;

FIG. 4 is an enlarged top plan view thereof;

FIG. 5 is an enlarged bottom plan view thereof;

FIG. 6 is an enlarged front elevational view thereof;

FIG. 7 is an enlarged back elevational view thereof;

FIG. 8 is an enlarged left side elevational view thereof; and

FIG. 9 is an enlarged right side elevational view thereof.

The broken lines in FIGS. 1 and 2 of the drawings are for illustrative purposes only.

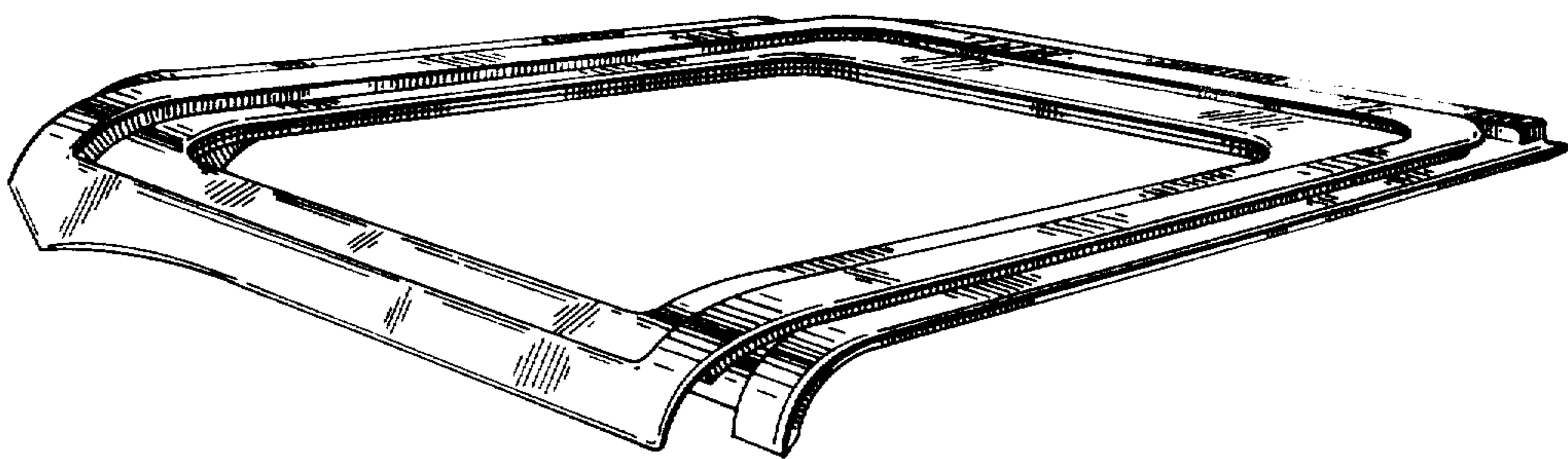

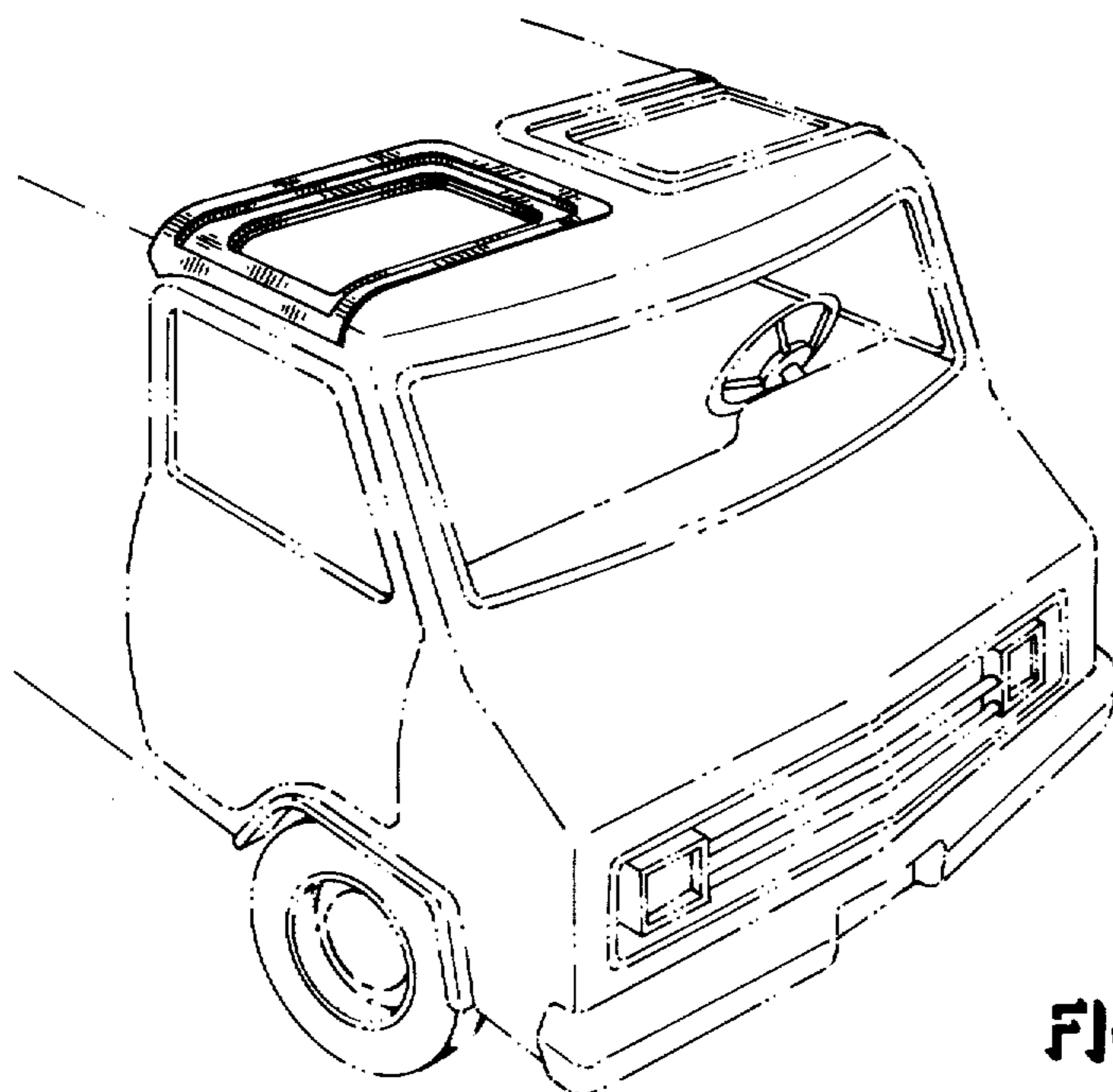

FIG. 1

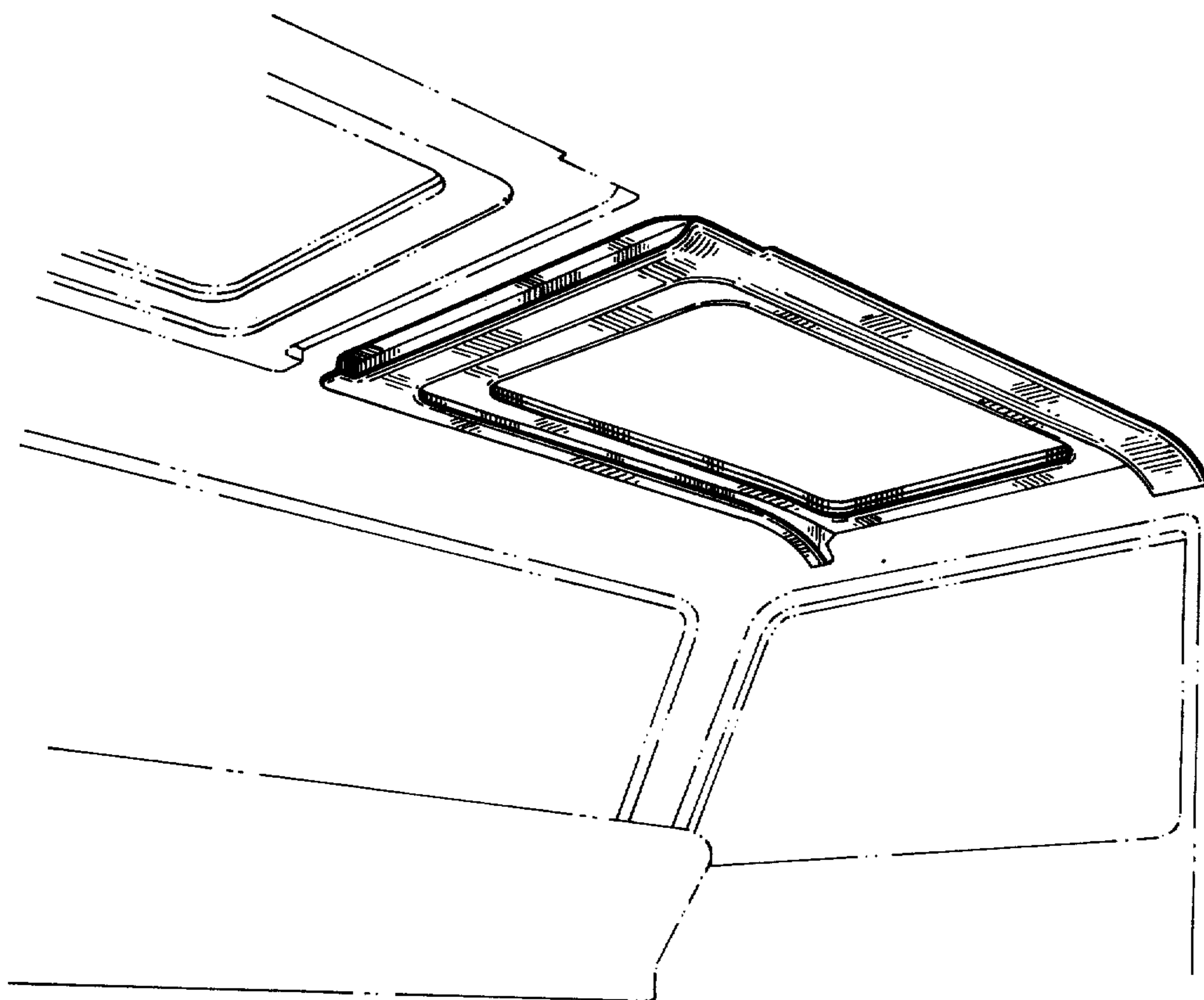

FIG. 2

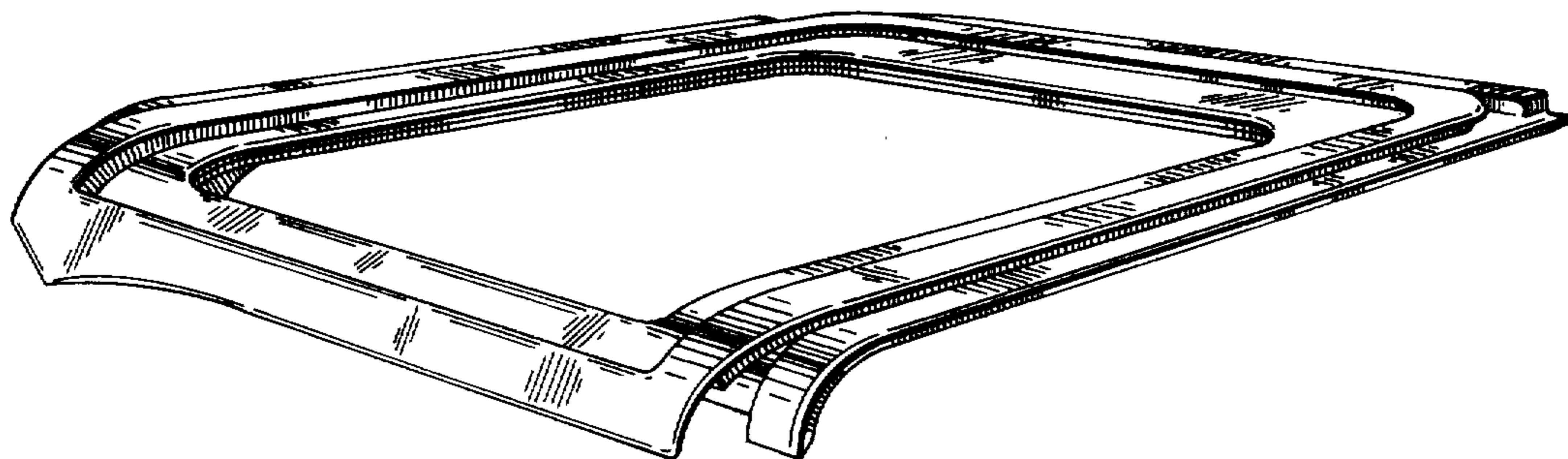

FIG. 3

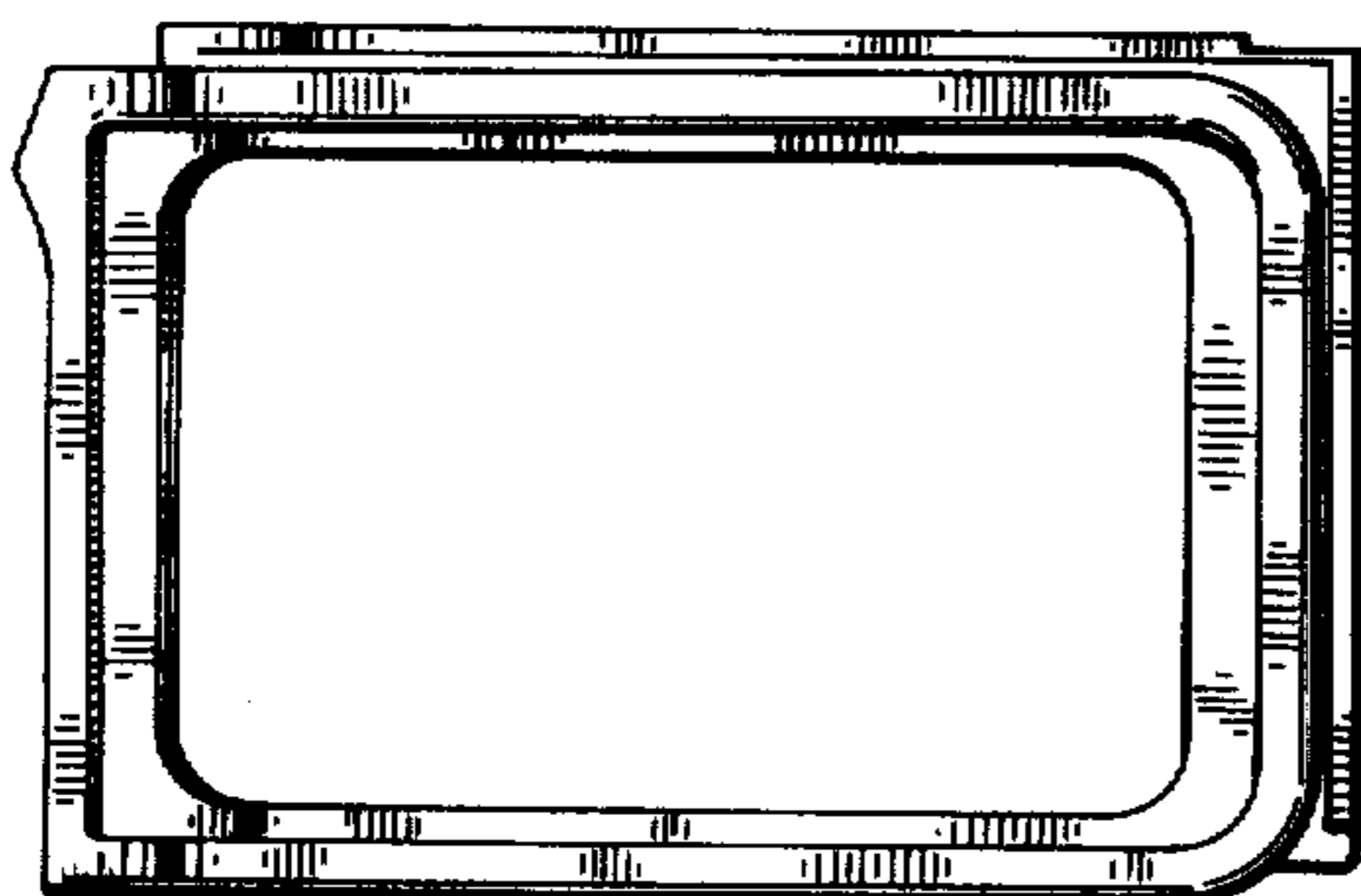

FIG. 4

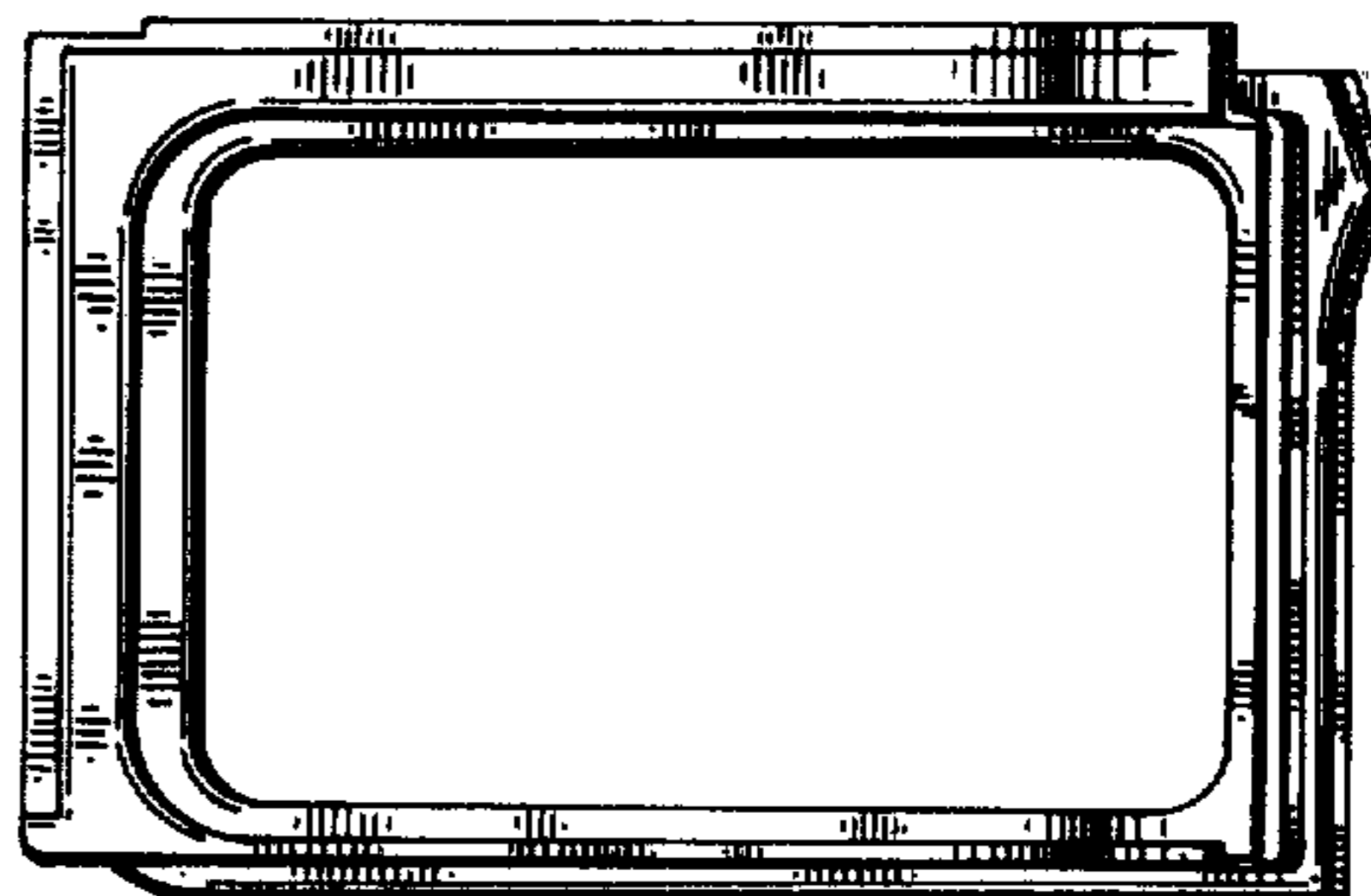

FIG. 5

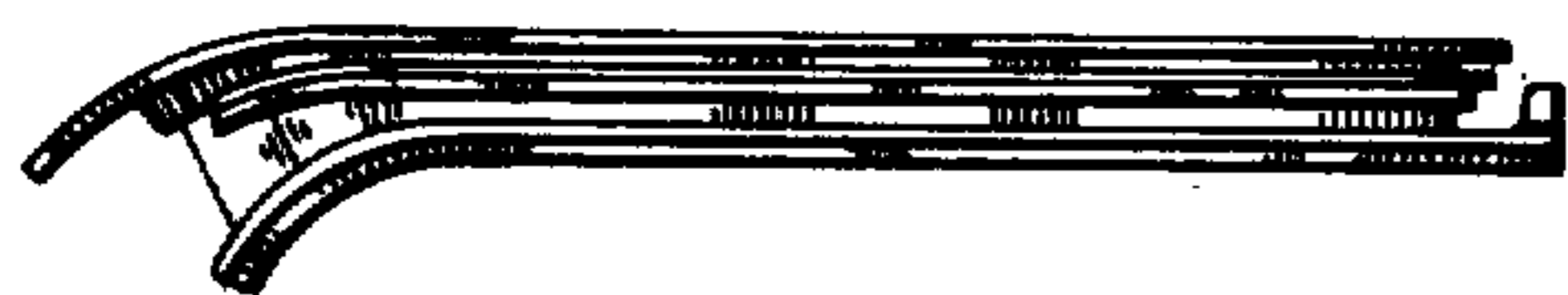

FIG. 6

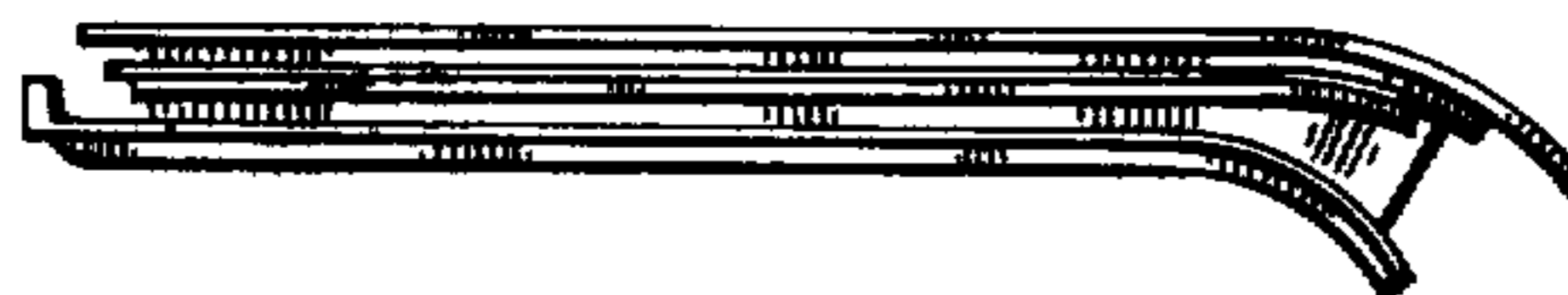

FIG. 7

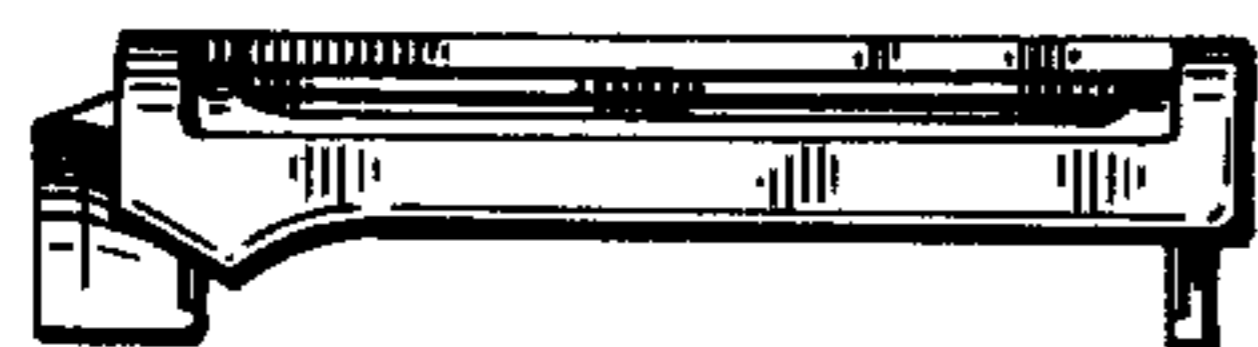

FIG. 8

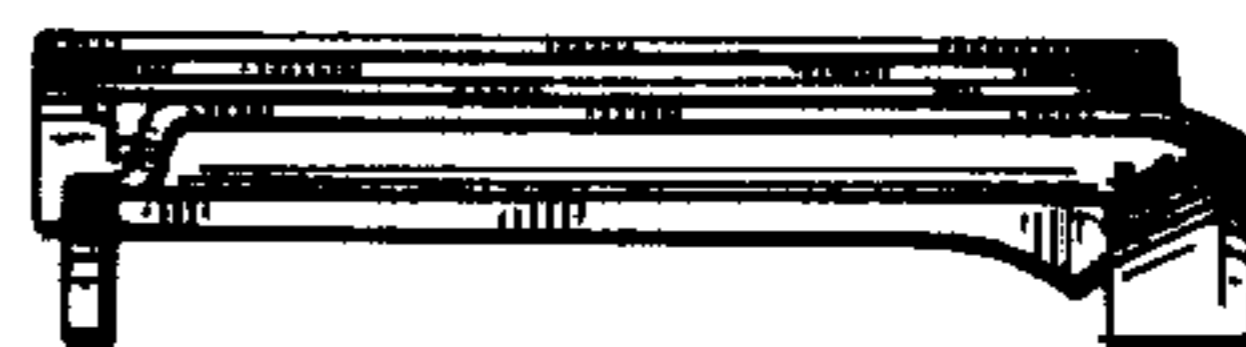

FIG. 9