

[54] **TOOTHBRUSH HOLDER**  
 [75] Inventor: **Allen W. Gelbard**, Hollywood, Calif.  
 [73] Assignee: **Bio Quant Research Corporation**,  
 New York, N.Y.  
 [\*\*] Term: **14 Years**  
 [21] Appl. No.: **93,243**  
 [22] Filed: **Nov. 13, 1979**

2,471,979 5/1949 Rozzi et al. .... D6/94  
 2,910,172 10/1959 Peaslee ..... 312/207  
 2,950,946 8/1960 Starworth ..... 206/362.3  
 3,228,737 1/1966 Kipnis ..... 312/206

*Primary Examiner*—B. J. Bullock  
*Attorney, Agent, or Firm*—Robert L. Slater, Jr.

[57] **CLAIM**

The ornamental design for a toothbrush holder, as shown and described.

**DESCRIPTION**

FIG. 1 is a front elevational view of a toothbrush holder embodying my new design;  
 FIG. 2 is a rear elevational view thereof;  
 FIG. 3 is a right side view thereof;  
 FIG. 4 is a left side view thereof.  
 FIG. 5 is a top plan view thereof;  
 FIG. 6 is a bottom plan view thereof; and  
 FIG. 7 is an exploded perspective view thereof.

[51] Int. Cl. .... **D23—02**  
 [52] U.S. Cl. .... **D6/94**  
 [58] Field of Search ..... D6/86, 94; 211/13, 60 R,  
 211/60 T, 87; 248/309 R, 110, 205 A; 206/361,  
 362.2, 362.3, 15.2, 15.3; 312/206, 207

[56] **References Cited**  
**U.S. PATENT DOCUMENTS**  
 D. 242,672 12/1976 Harris ..... D6/94

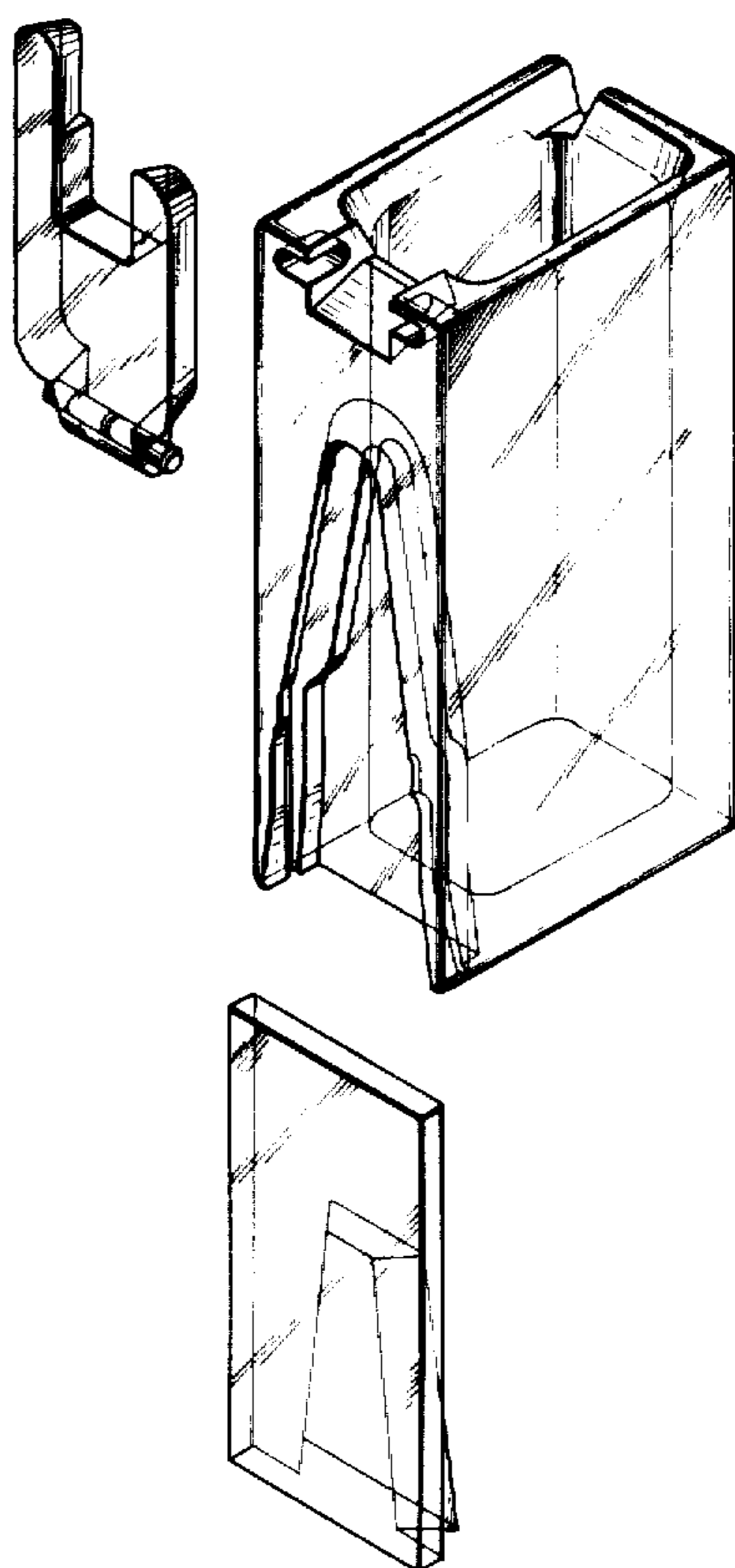

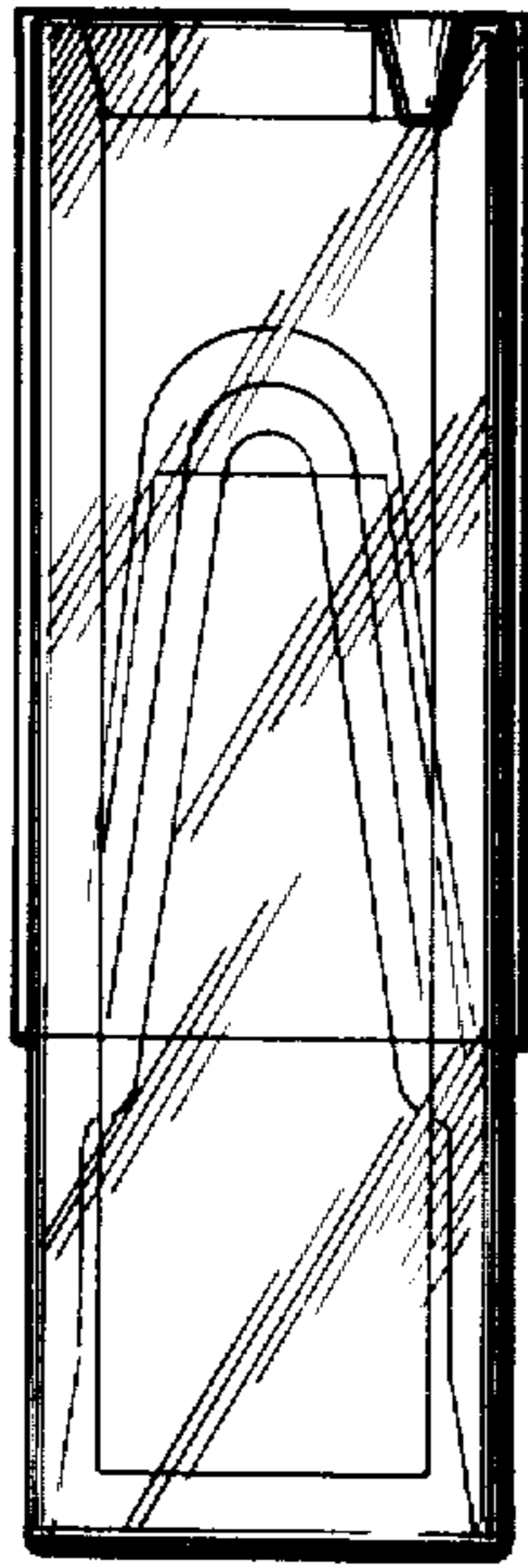

FIG. 1

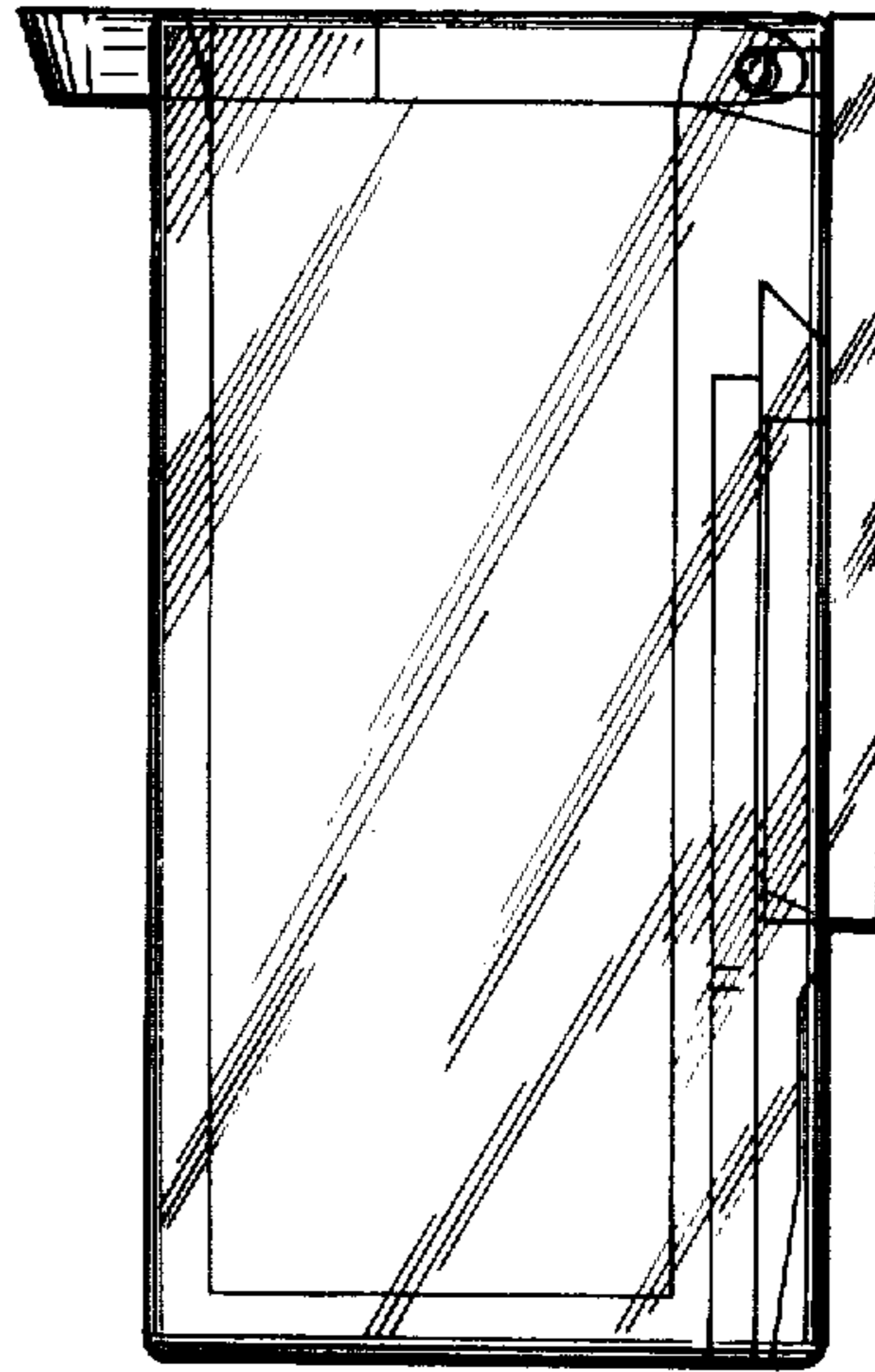

FIG. 3



FIG. 2

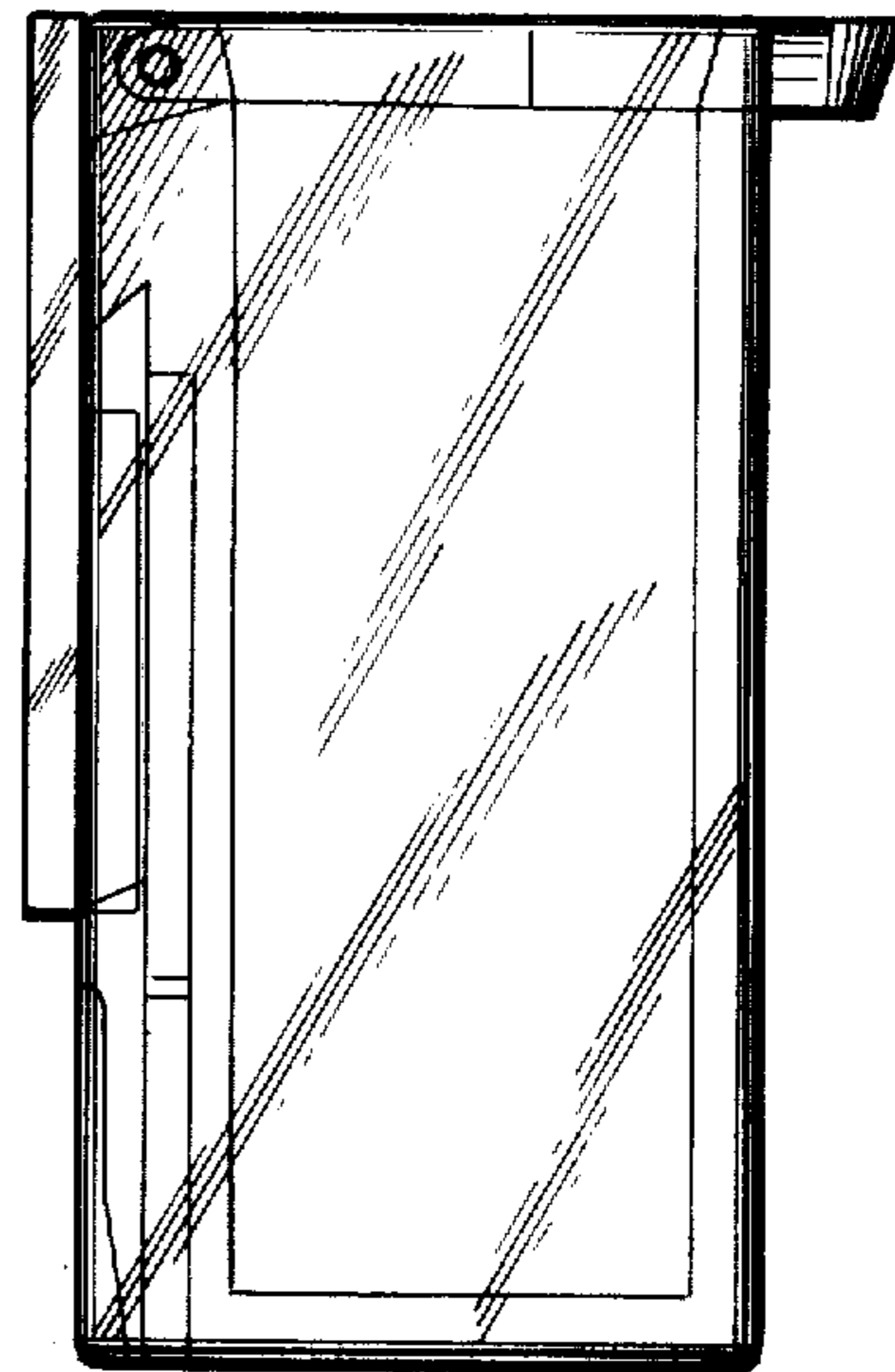

FIG. 4

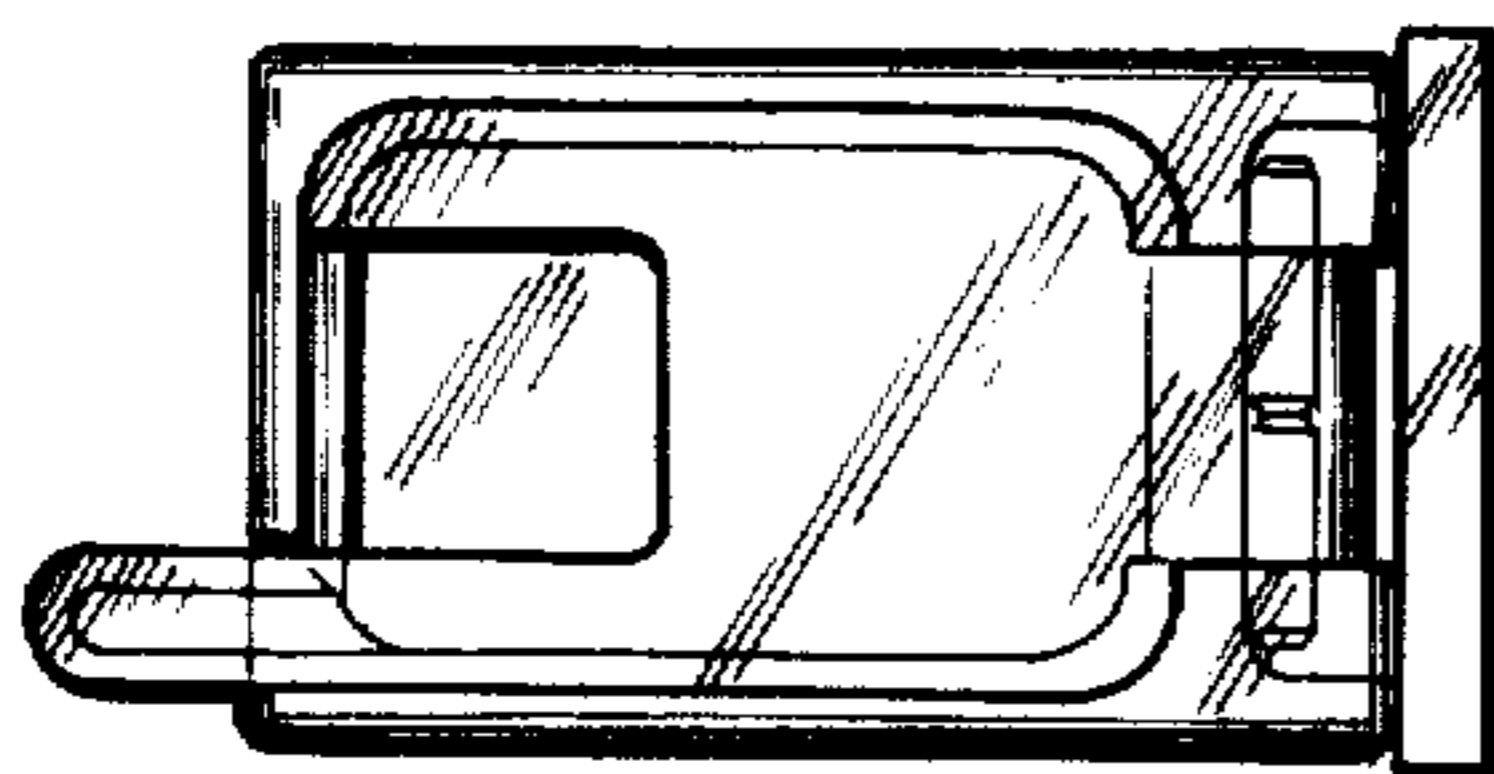

FIG. 5

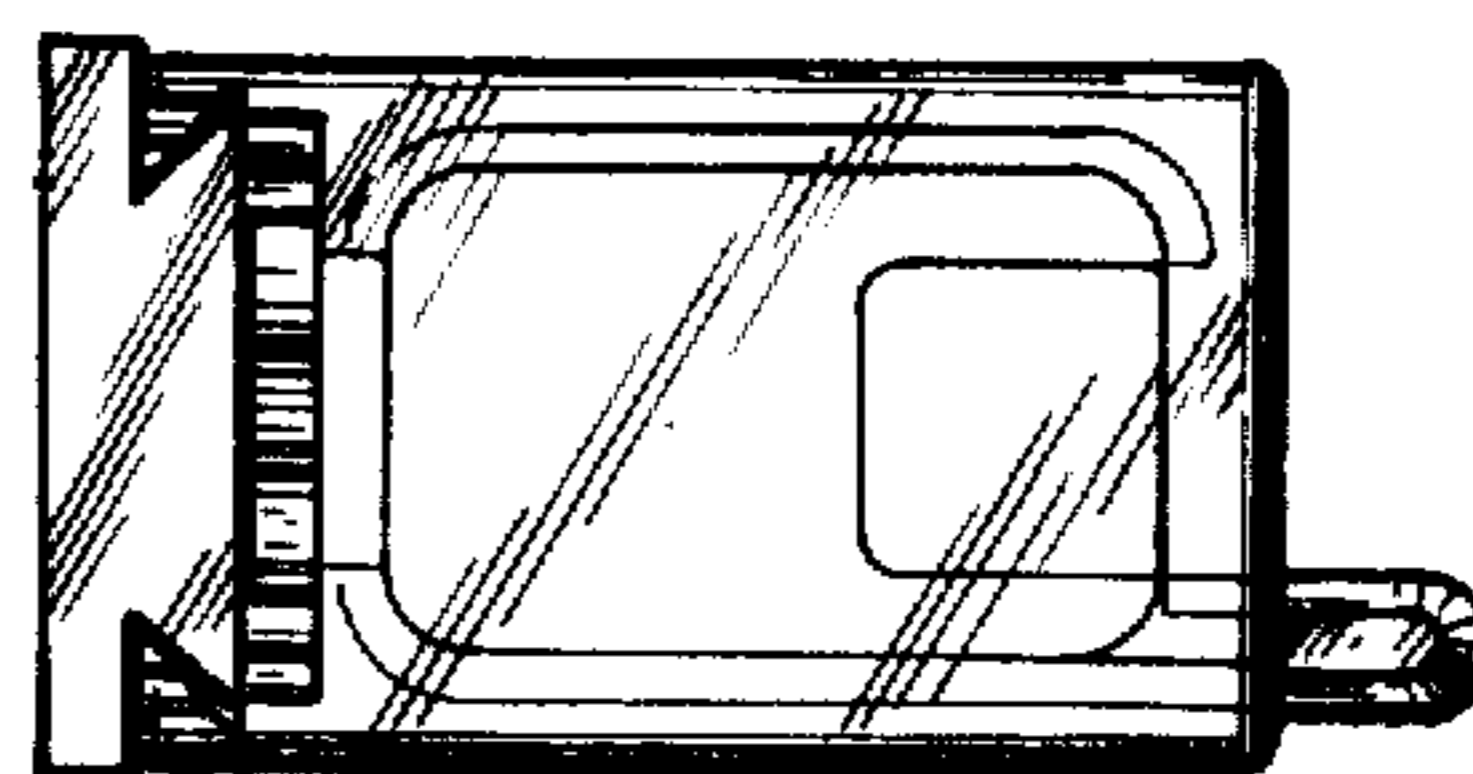

FIG. 6

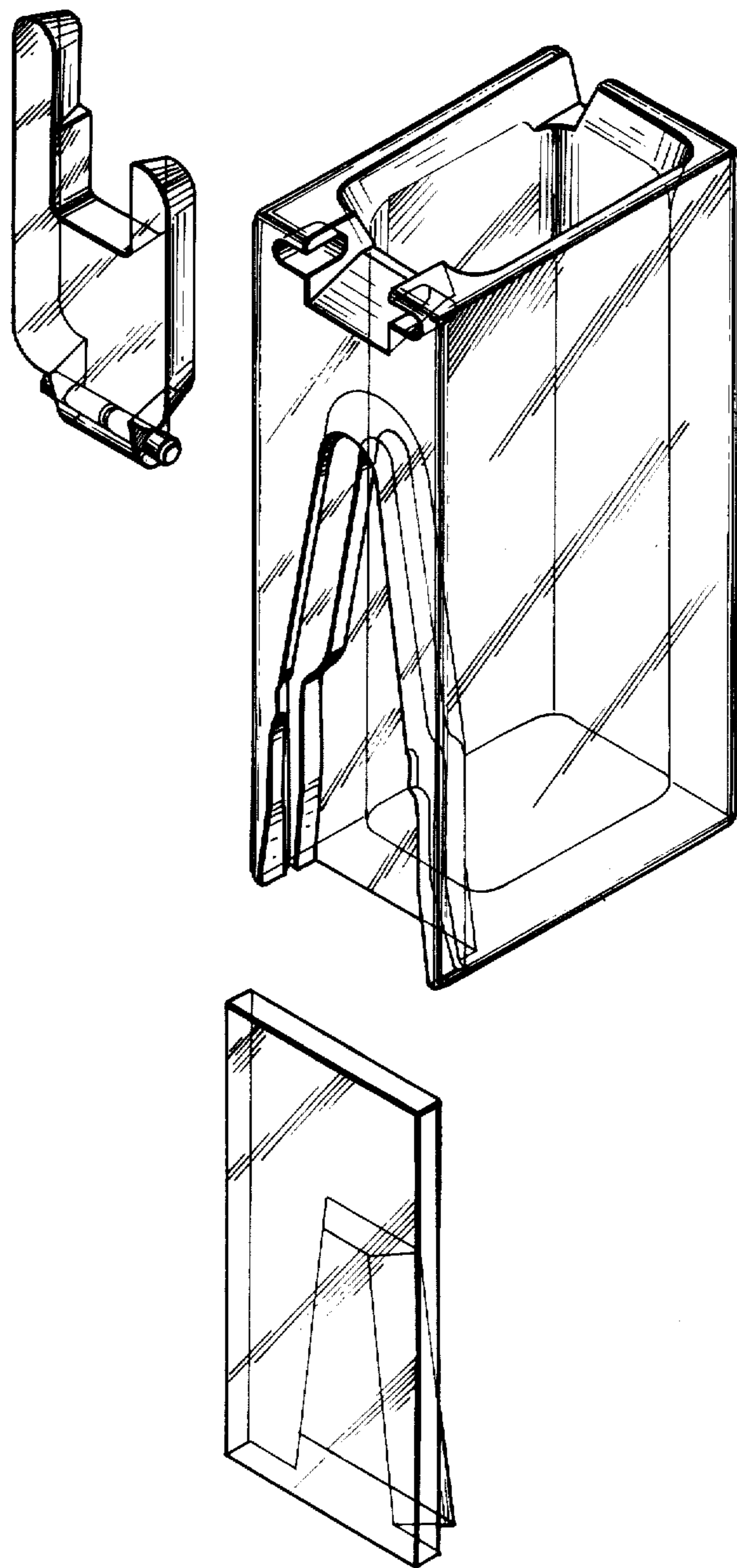

FIG. 7