

[54] GOLF CLUB HEAD

[75] Inventor: Masashi Kobayashi, Matsudo, Japan

[73] Assignee: Maruman Golf Kabushiki Kaisha, Tokyo, Japan

[**] Term: 14 Years

[21] Appl. No.: 101,065

[22] Filed: Dec. 7, 1979

[30] Foreign Application Priority Data

Jul. 21, 1979 [JP] Japan 54-030463

[51] Int. Cl. D21-02

[52] U.S. Cl. D21/219; D21/220

[58] Field of Search D21/214-220; 273/167-175, 164

[56] References Cited

U.S. PATENT DOCUMENTS

D. 220,506 4/1971 Mader D21/219

OTHER PUBLICATIONS

Golf Digest, Jun. 1969, p. 94, upper right, Inverted Loft Putter.

Golf Digest, Dec. 1974, p. 2, "Stag" Iron.

Primary Examiner—Melvin B. Feifer
Attorney, Agent, or Firm—Armstrong, Nikaido, Marmelstein & Kubovcik

[57] CLAIM

The ornamental design for a golf club head, as shown and described.

DESCRIPTION

FIG. 1 is a plan view of a gold club head showing my new design.

FIG. 2 is a left side view thereof.

FIG. 3 is a front elevation thereof.

FIG. 4 is a bottom view thereof.

FIG. 5 is a right side view thereof.

FIG. 6 is a rear elevation thereof.

FIG. 7 is a section through section VII—VII thereof.

FIG. 8 is a rear perspective view thereof.

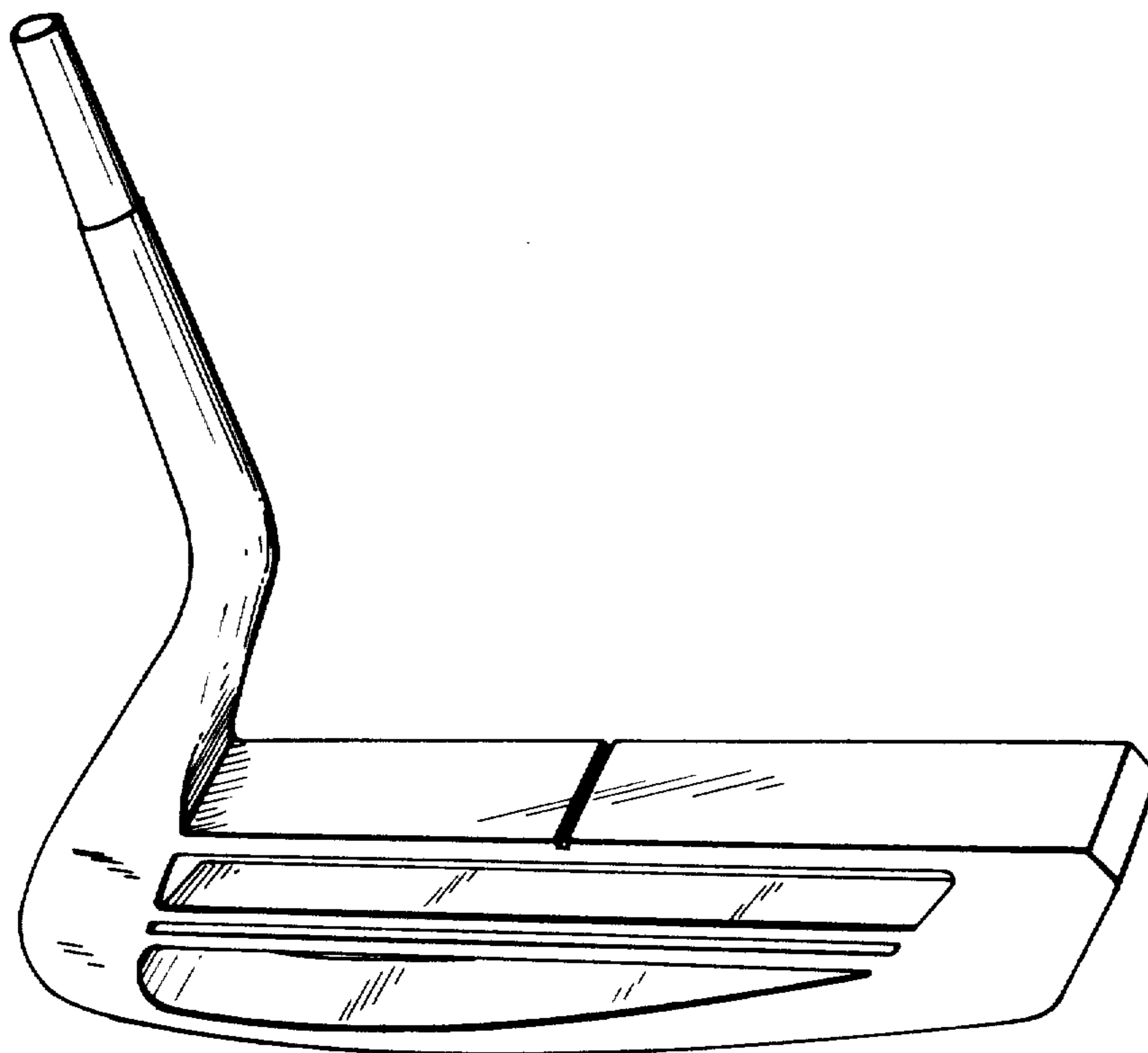

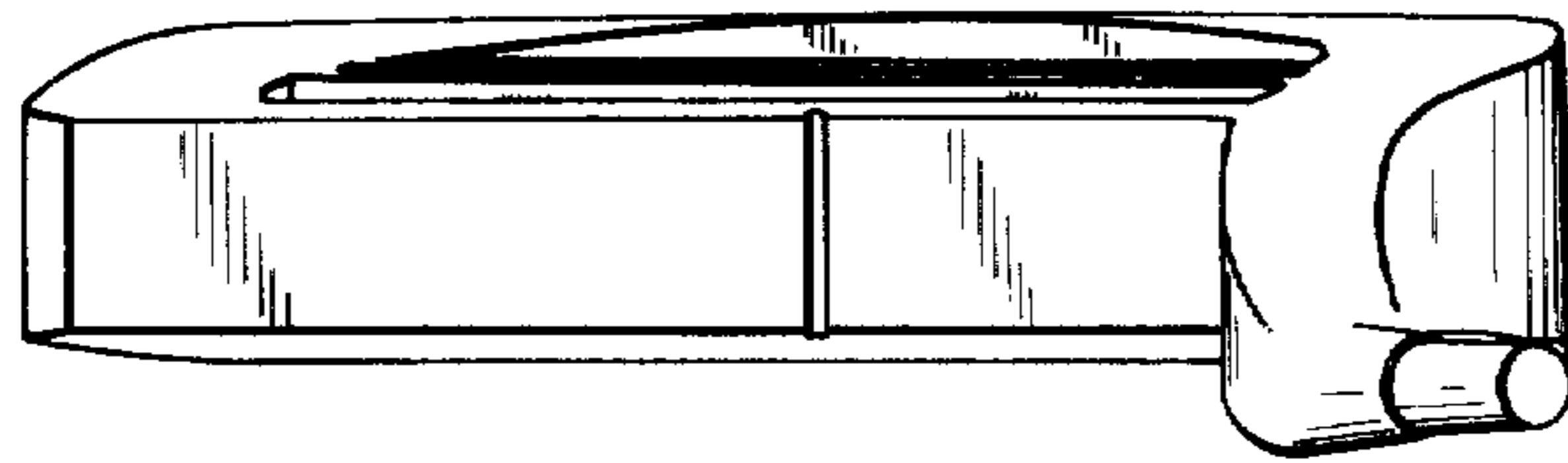

FIG. 1

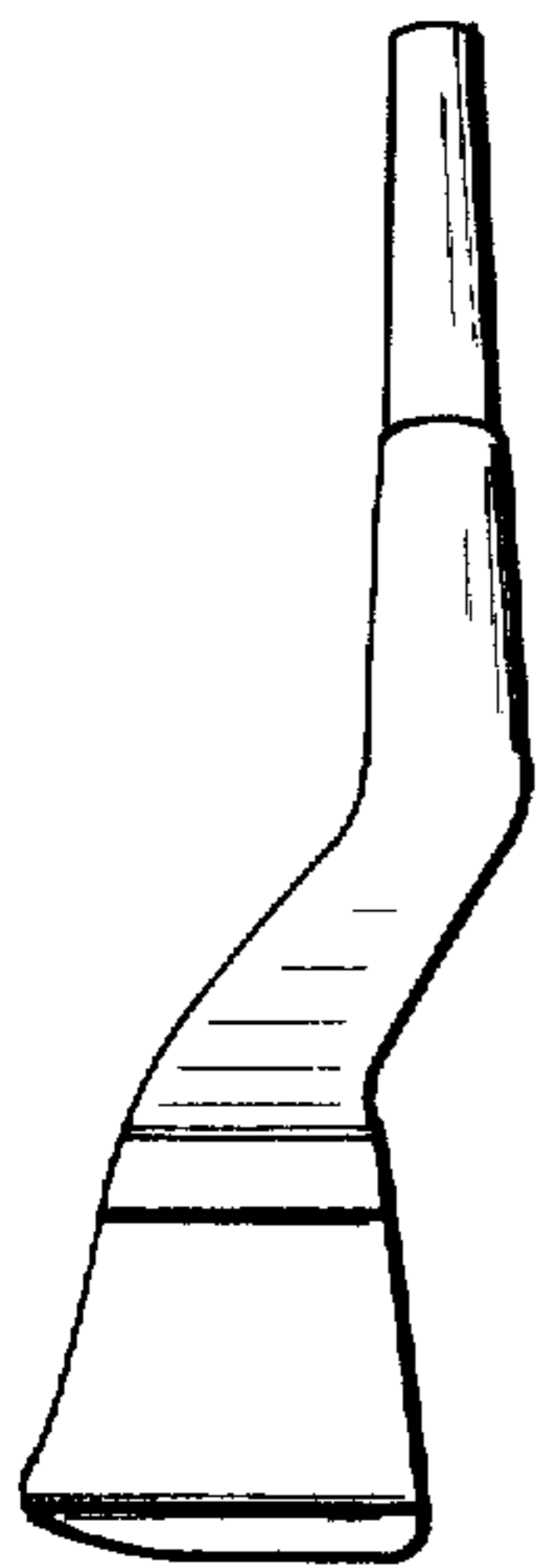

FIG. 2

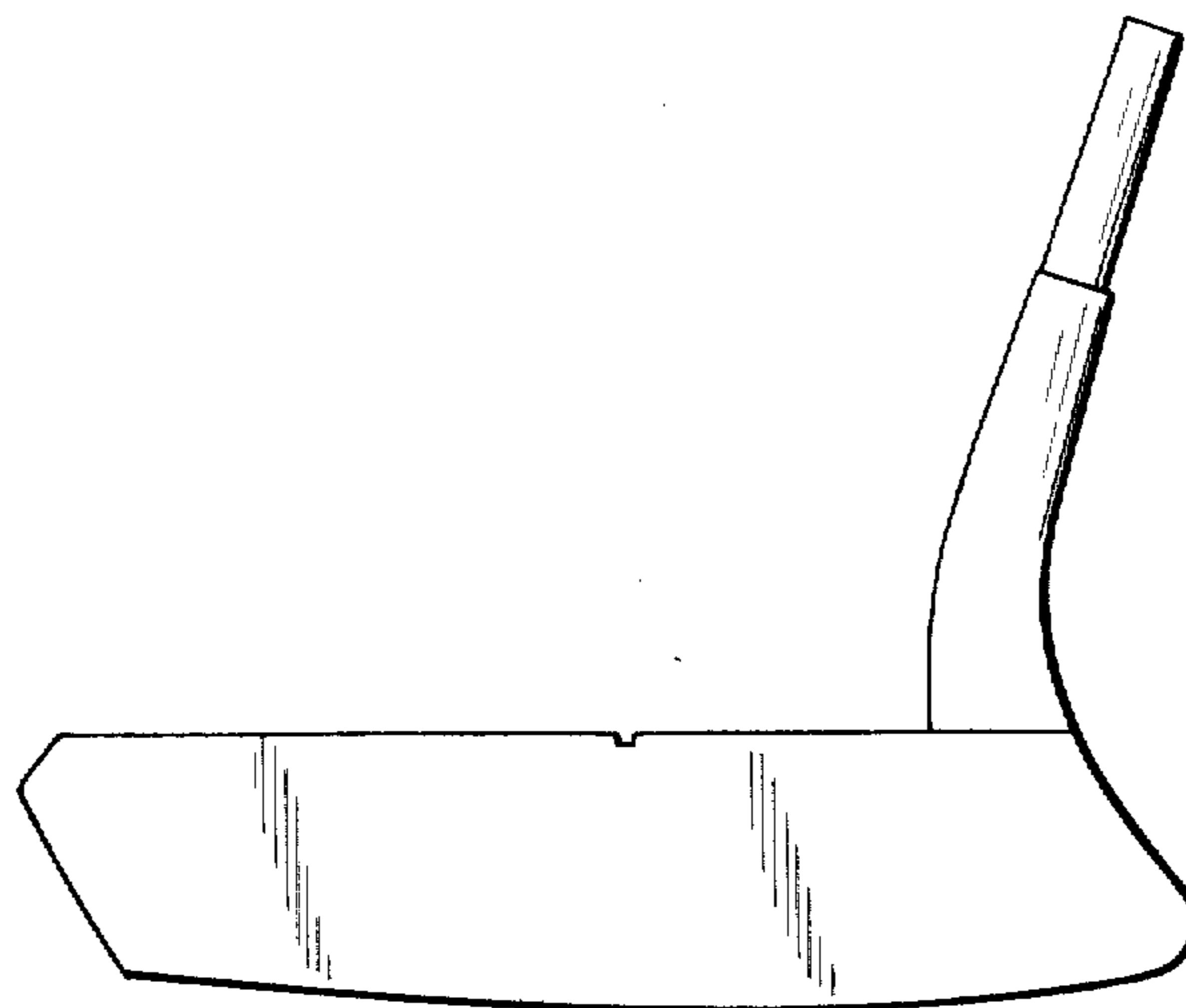

FIG. 3

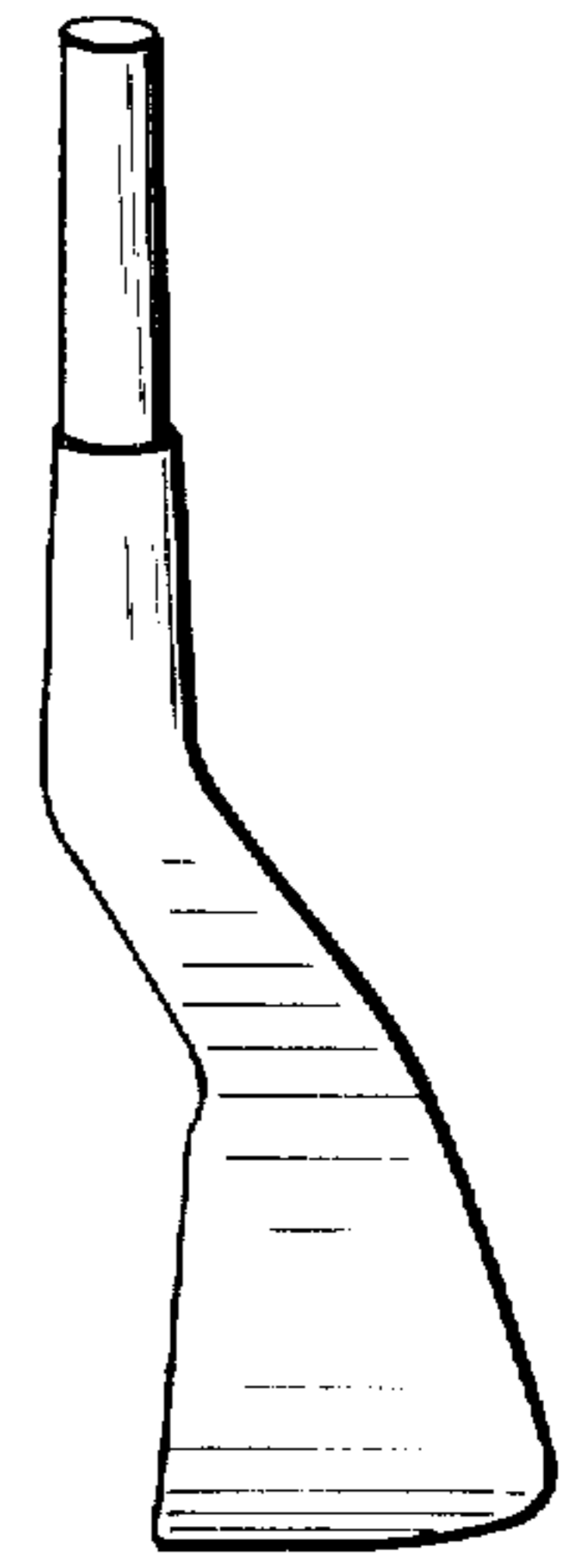

FIG. 5

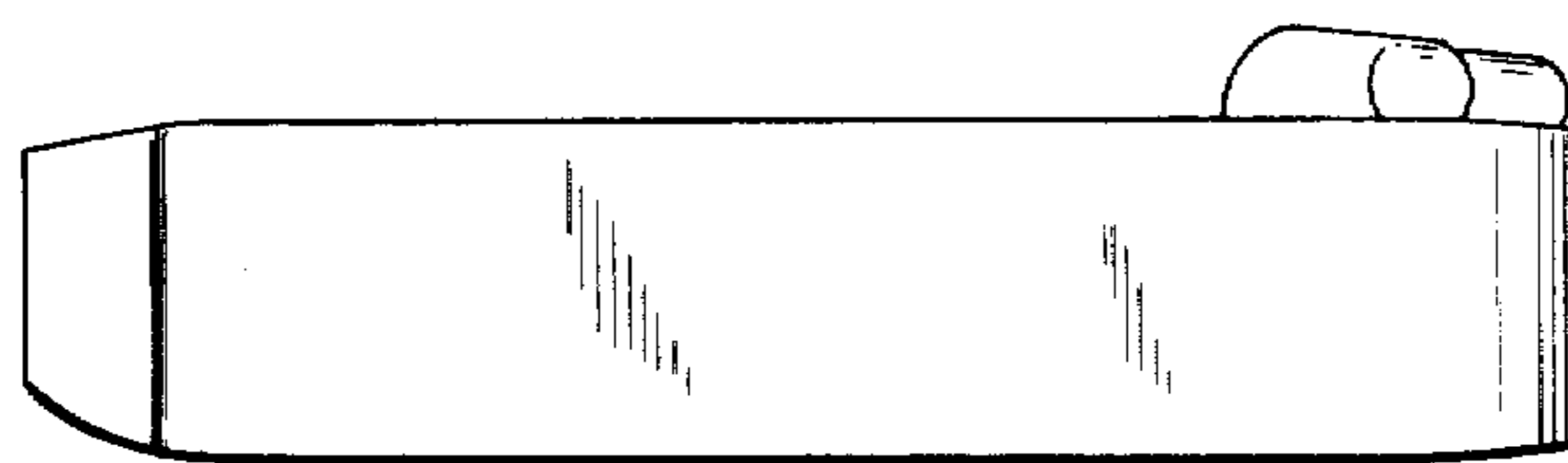

FIG. 4

FIG. 6

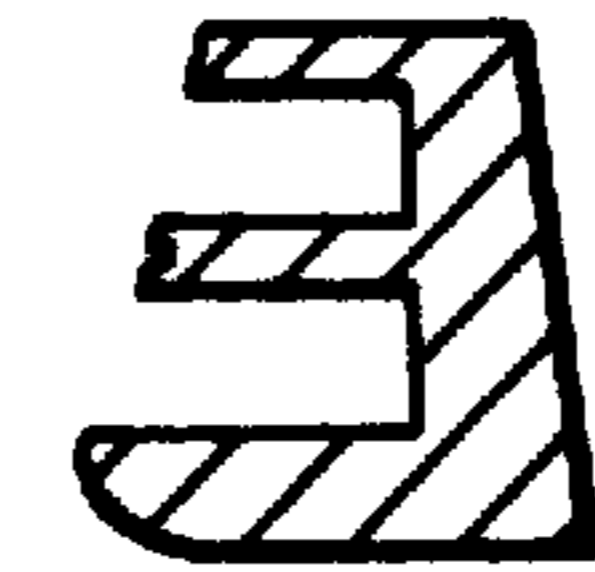
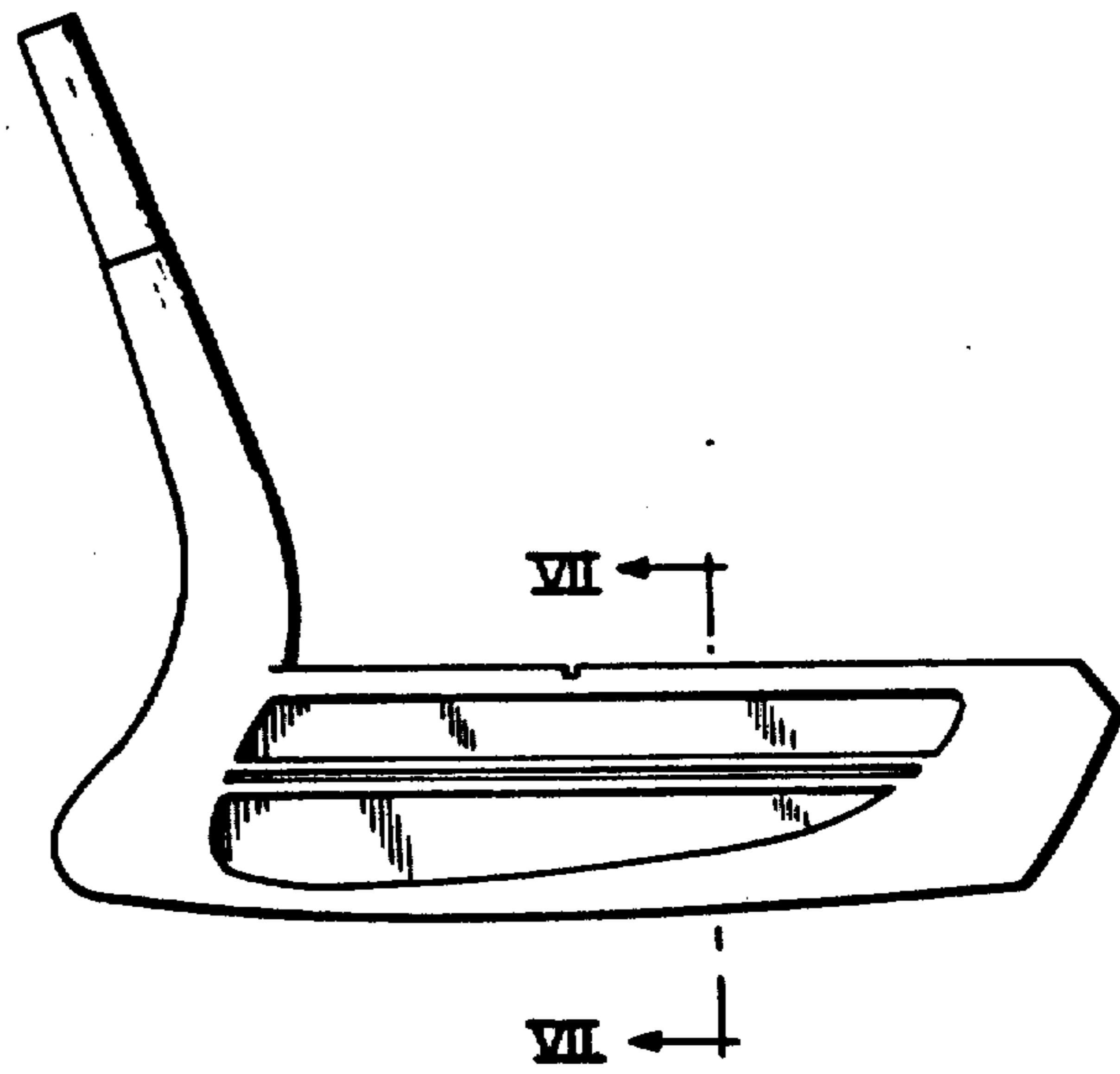

FIG. 7

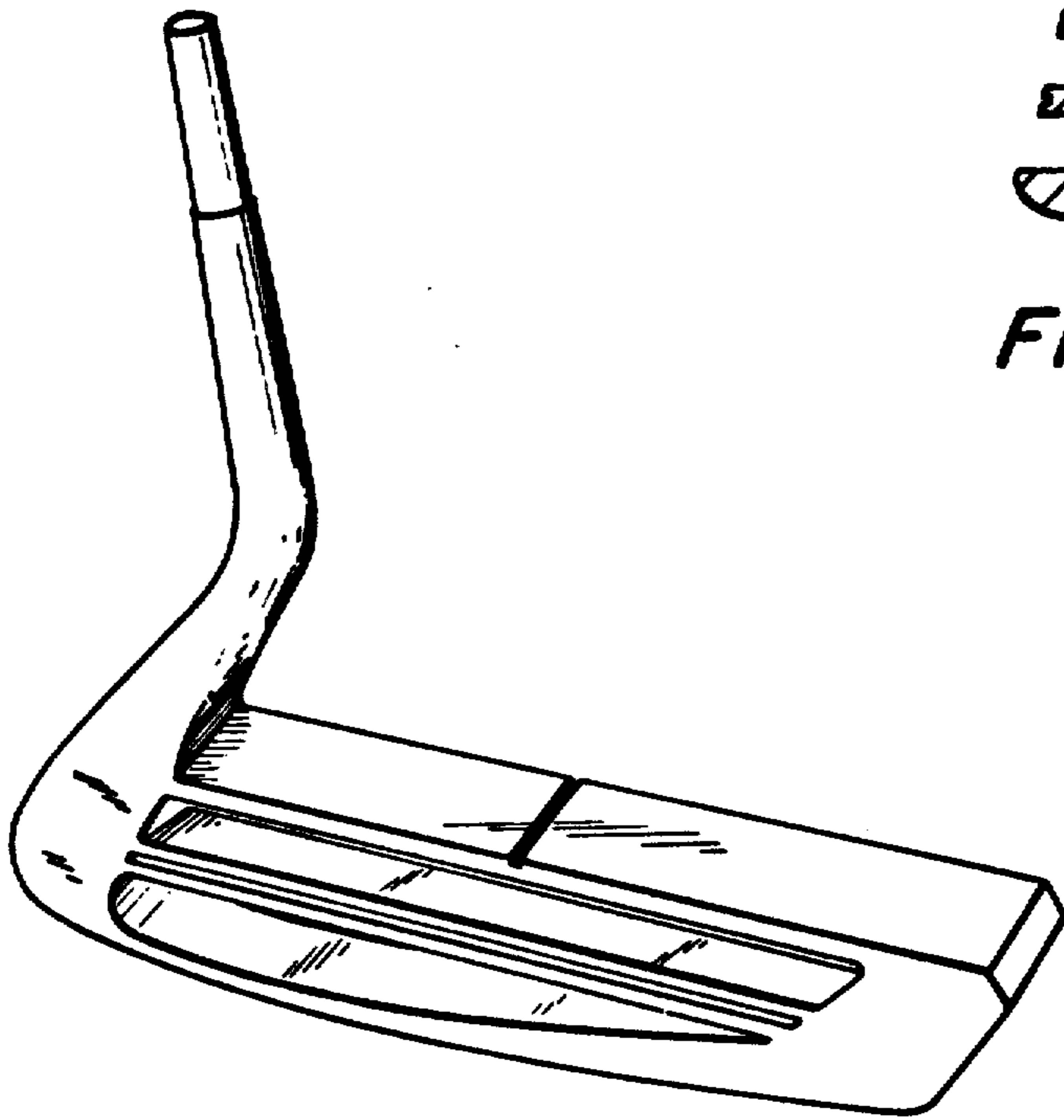

FIG. 8