

[54] COMBINED BEVERAGE CUP AND HOLDER

[75] Inventor: Jorma Vennola, Iittala, Finland

[73] Assignee: A. Ahlstrom Osakeyhtio, Noormarkku, Finland

[**] Term: 14 Years

[21] Appl. No.: 4,388

[22] Filed: Jan. 18, 1979

[51] Int. Cl. D07-01

[52] U.S. Cl. D7/3; D7/11; D7/13; D7/70

[58] Field of Search D7/6-15, D7/70, 3; D11/144, 146, 152, 153, 154

[56] References Cited

U.S. PATENT DOCUMENTS

- D. 112,751 12/1938 Bowes D7/70 X
- D. 146,338 2/1947 Manzeroll D7/7
- D. 161,115 12/1950 Meier D7/13
- D. 195,309 5/1963 Mount et al. D7/70
- D. 205,368 7/1966 Makara D7/9
- D. 213,389 2/1969 Weitzman D7/9

FOREIGN PATENT DOCUMENTS

250887 4/1926 United Kingdom D7/13

OTHER PUBLICATIONS

Gifts & Decorative Accessories, Dec. 1977, p. 259, Sasaki Stemware, top panel, middle and left col.

Primary Examiner—Winifred E. Herrmann

Attorney, Agent, or Firm—Bucknam and Archer

[57] CLAIM

The ornamental design for a combined beverage cup and holder, as shown.

DESCRIPTION

FIG. 1 is a perspective exploded view of a combined beverage cup and holder showing my new design.

FIG. 2 is an elevational view thereof, partly in cross section.

FIG. 3 is an elevational view of a modification of the design of the combined beverage cup and holder of FIG. 1.

FIG. 4 is an elevational view of another modification of the design of the combined beverage cup and holder of FIG. 1.

FIG. 5 is a top plan view of the holder of FIG. 1.

FIG. 6 is an elevational view of the holder of FIGS. 1, 2, 3, 4 and 5.

FIG. 7 is a bottom plan view of the holder of FIGS. 1, 2, 3, 4, and 5.

FIG. 8 is a top plan view of the beverage cup of FIG. 1.

FIG. 9 is an elevational view of the beverage cup of the design of FIG. 1.

FIG. 10 is a top plan view of the beverage cup of FIG. 3.

FIG. 11 is an elevational view of the beverage cup of FIG. 3.

FIG. 12 is a top plan view of the beverage cup of FIG. 4.

FIG. 13 is an elevational view of the beverage cup of FIG. 4.

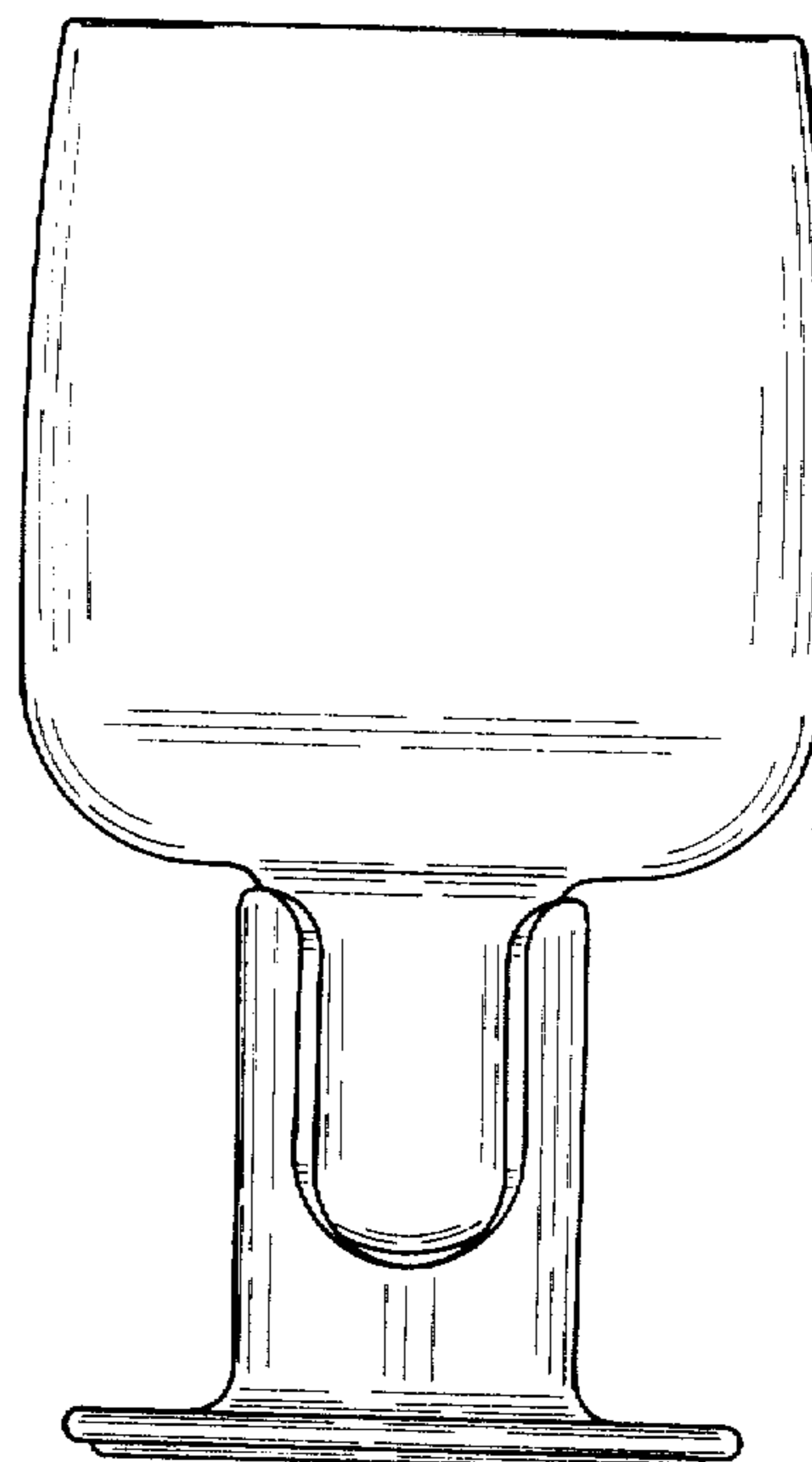
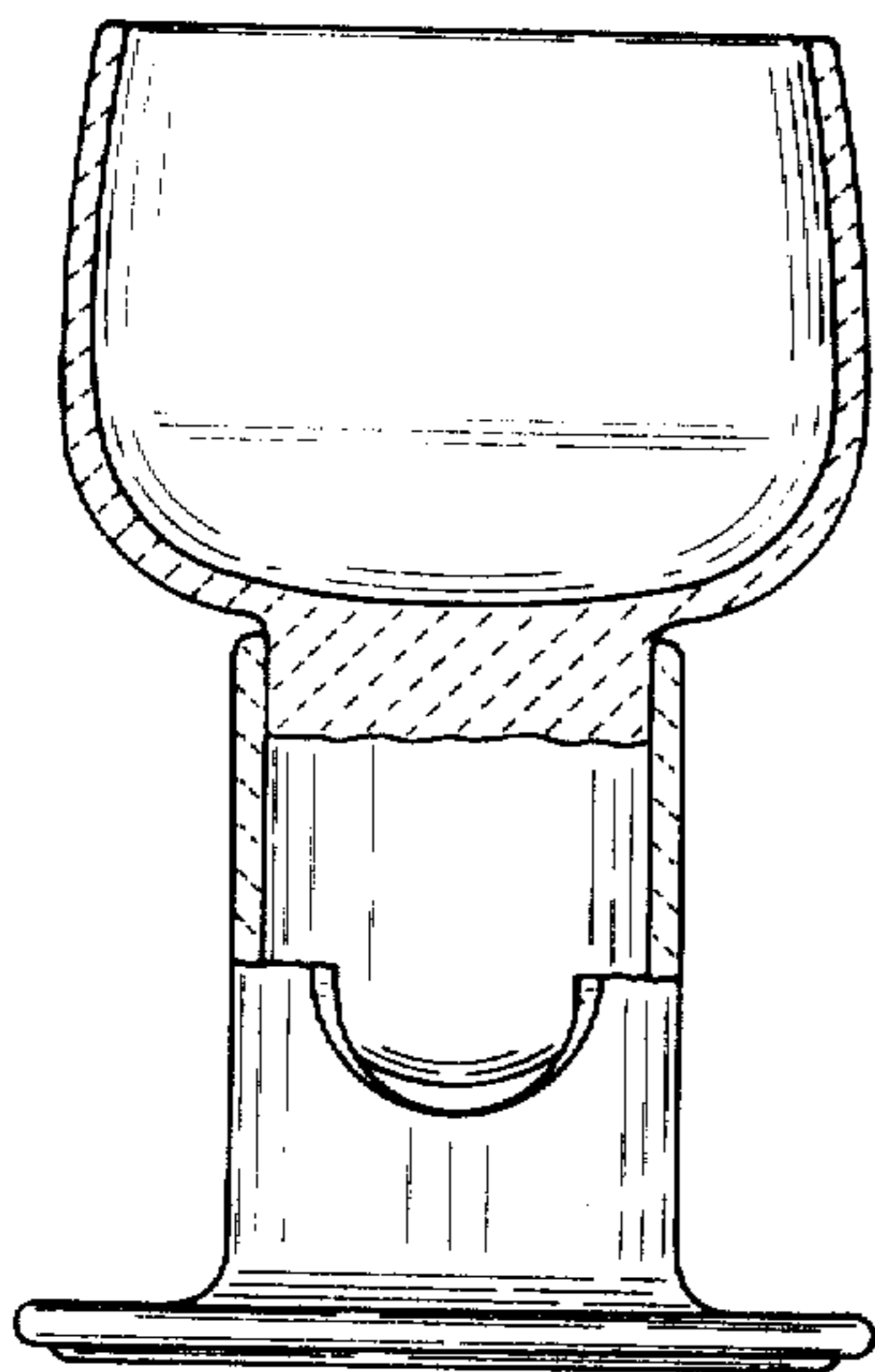

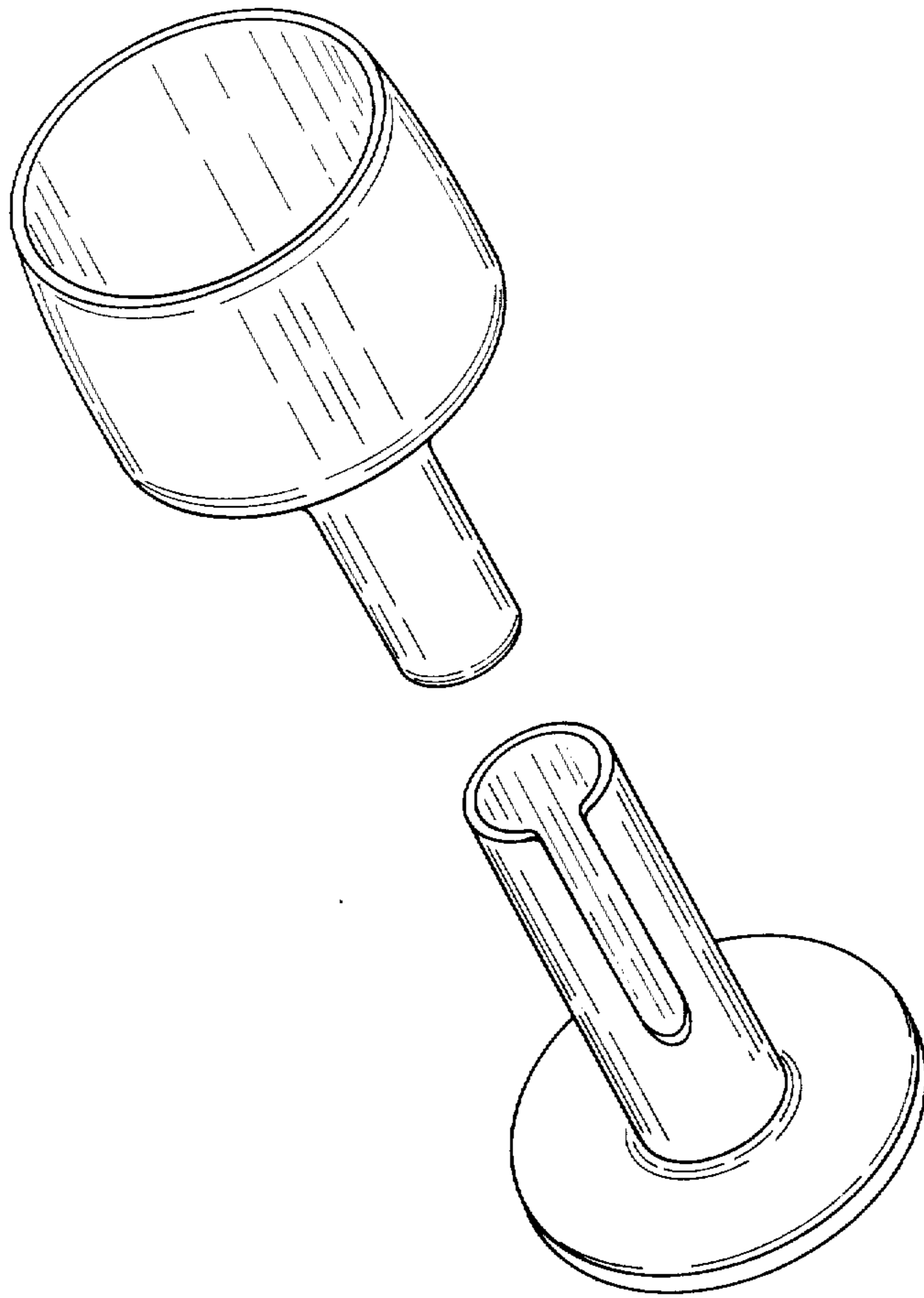

FIG. 1

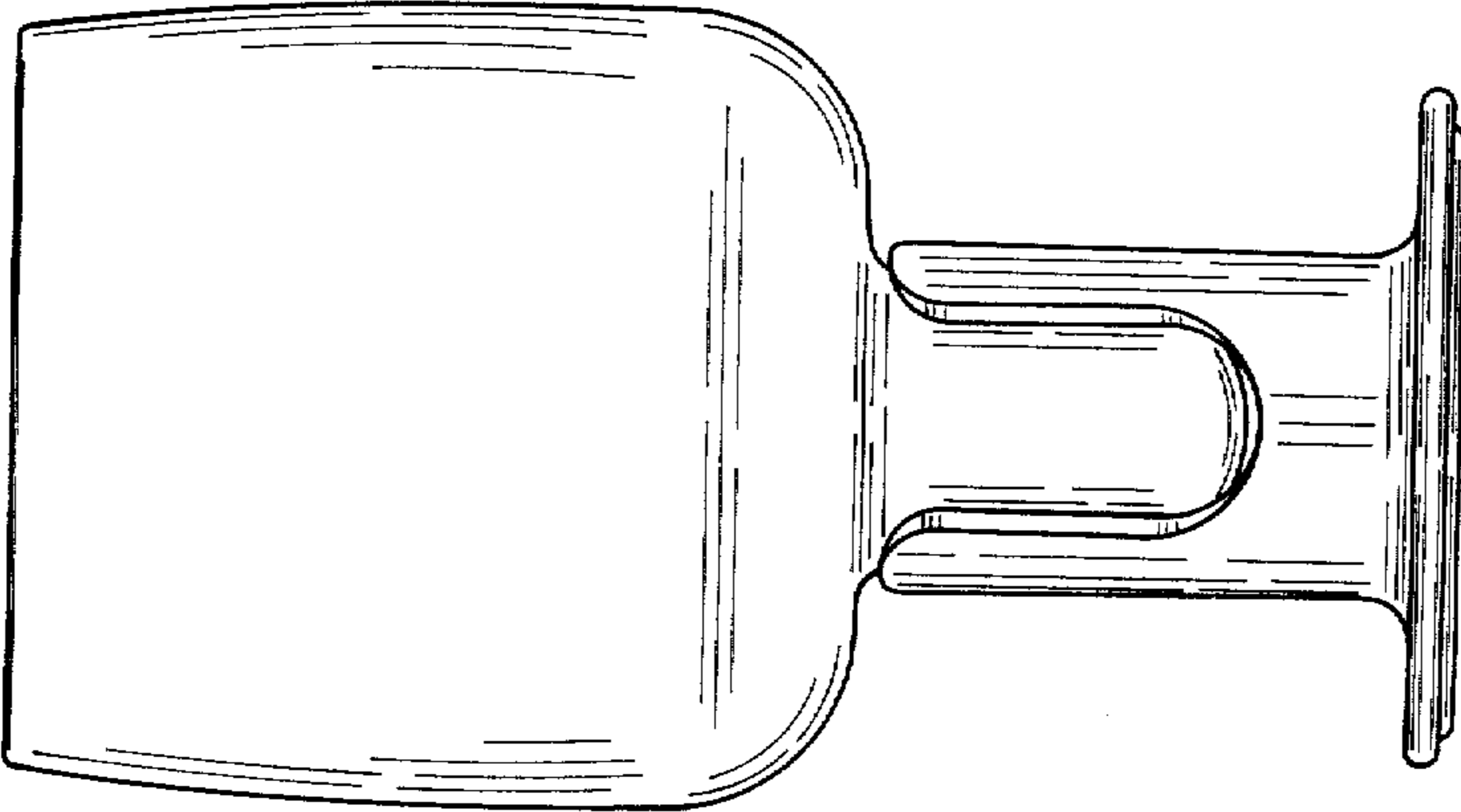

FIG.4

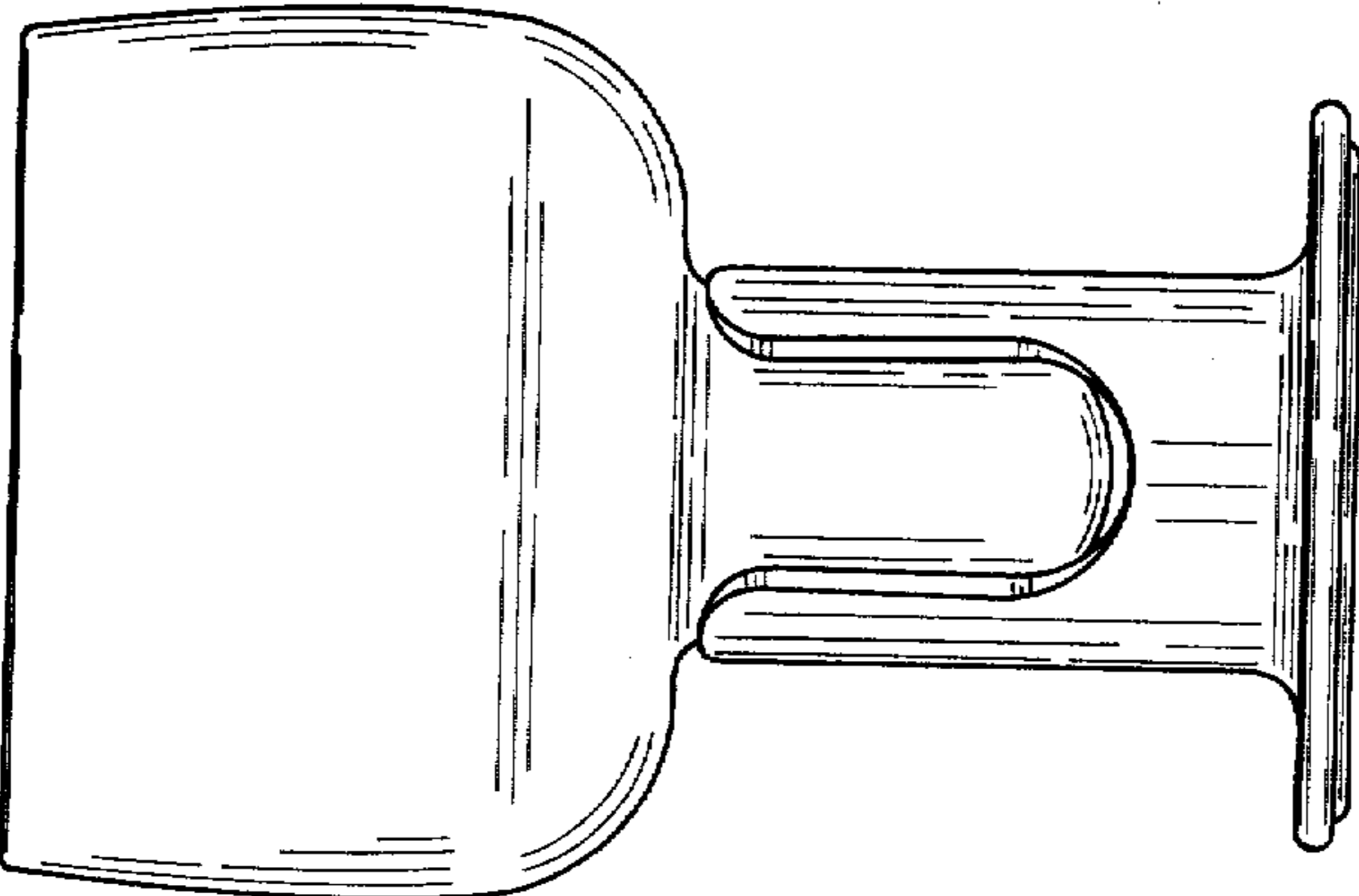

FIG.3

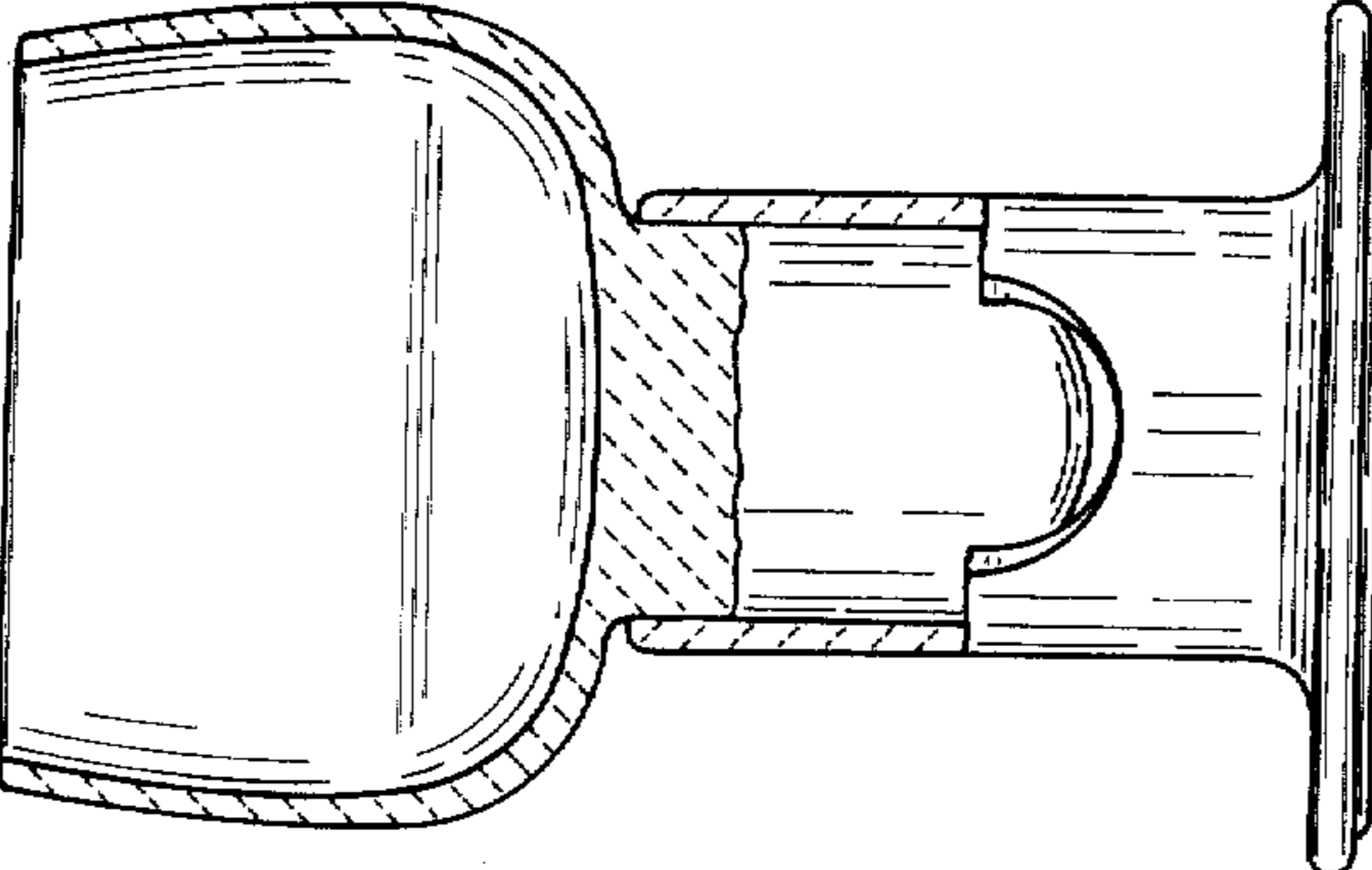

FIG.2

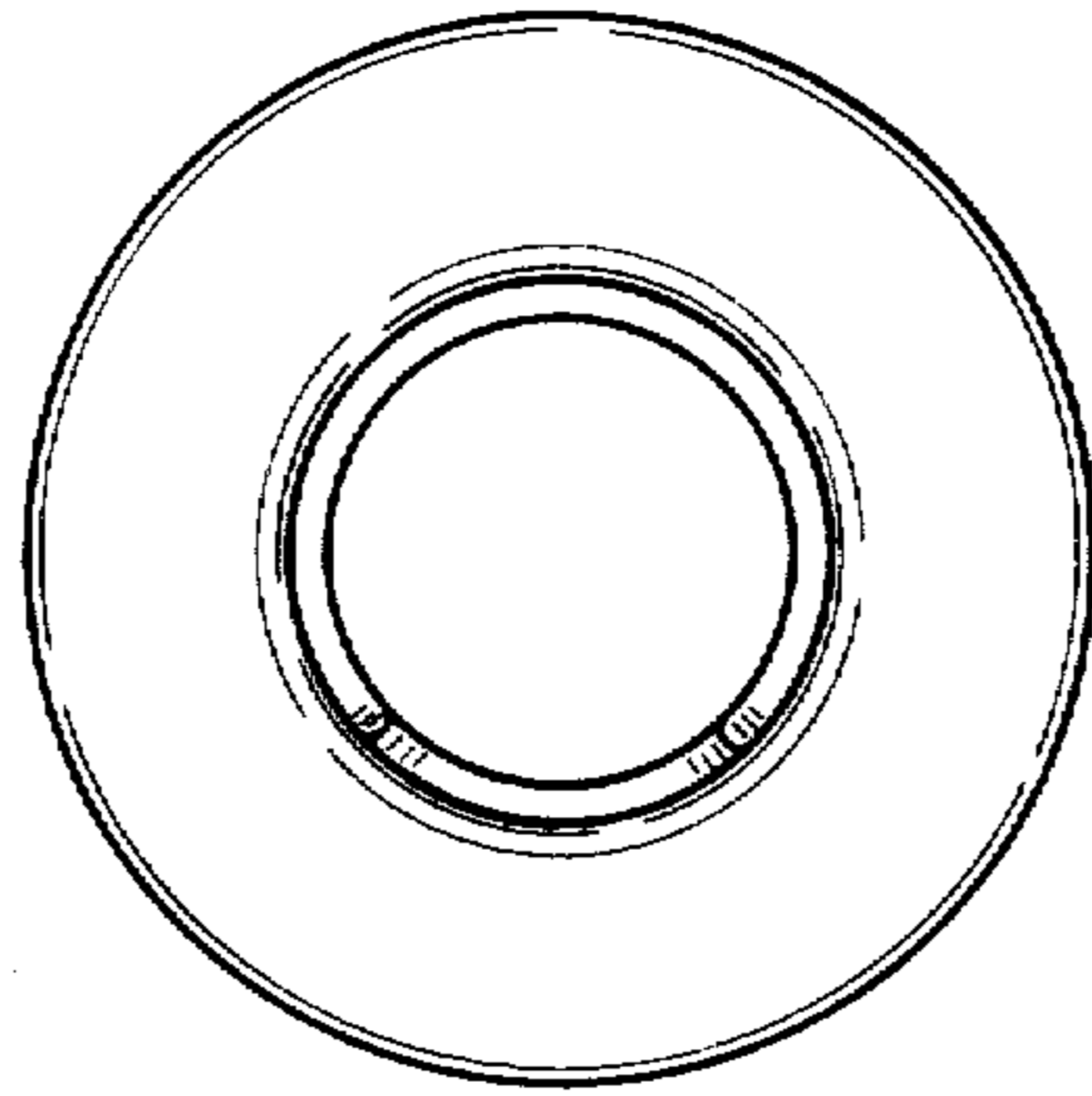

FIG.5

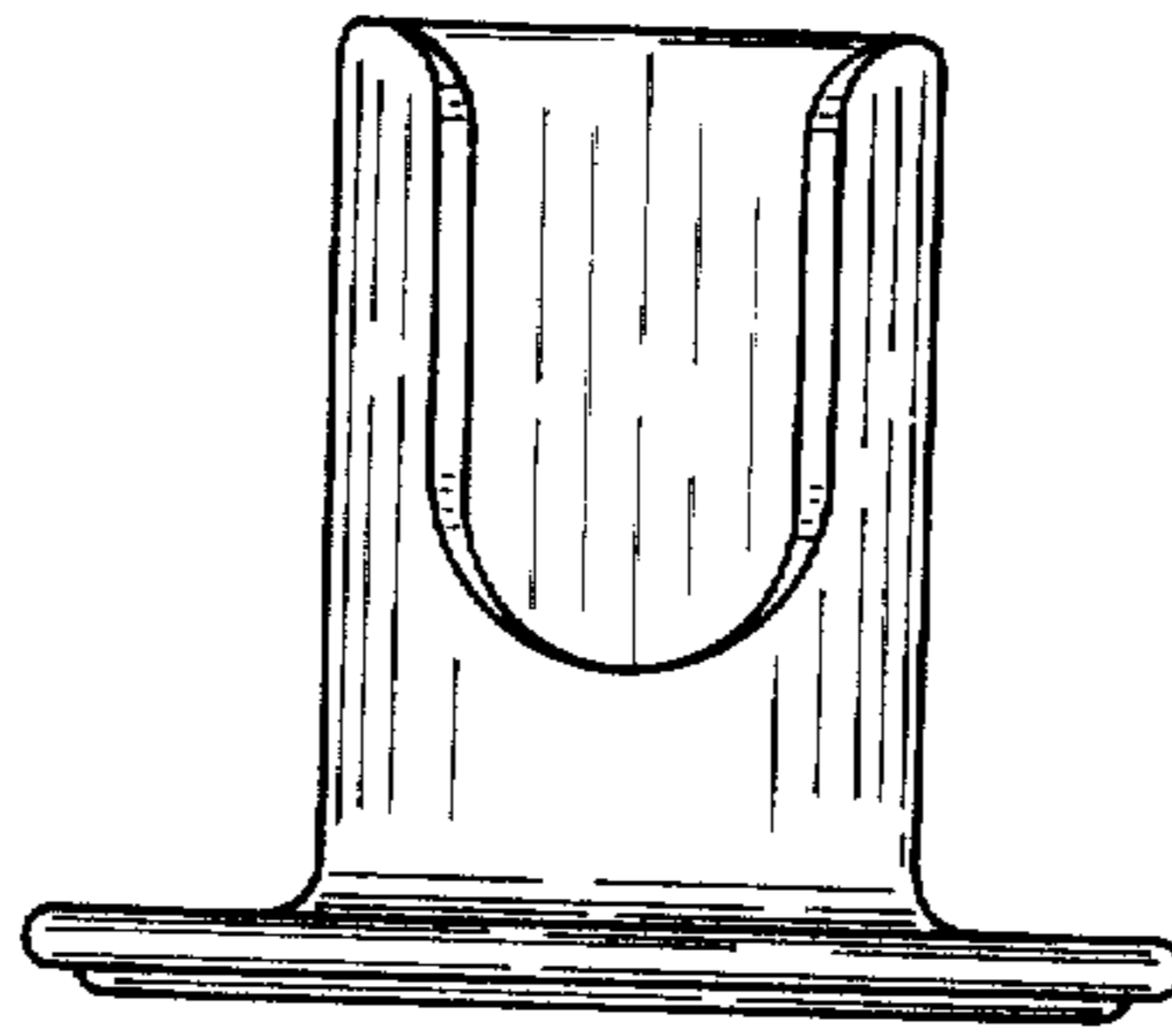

FIG.6

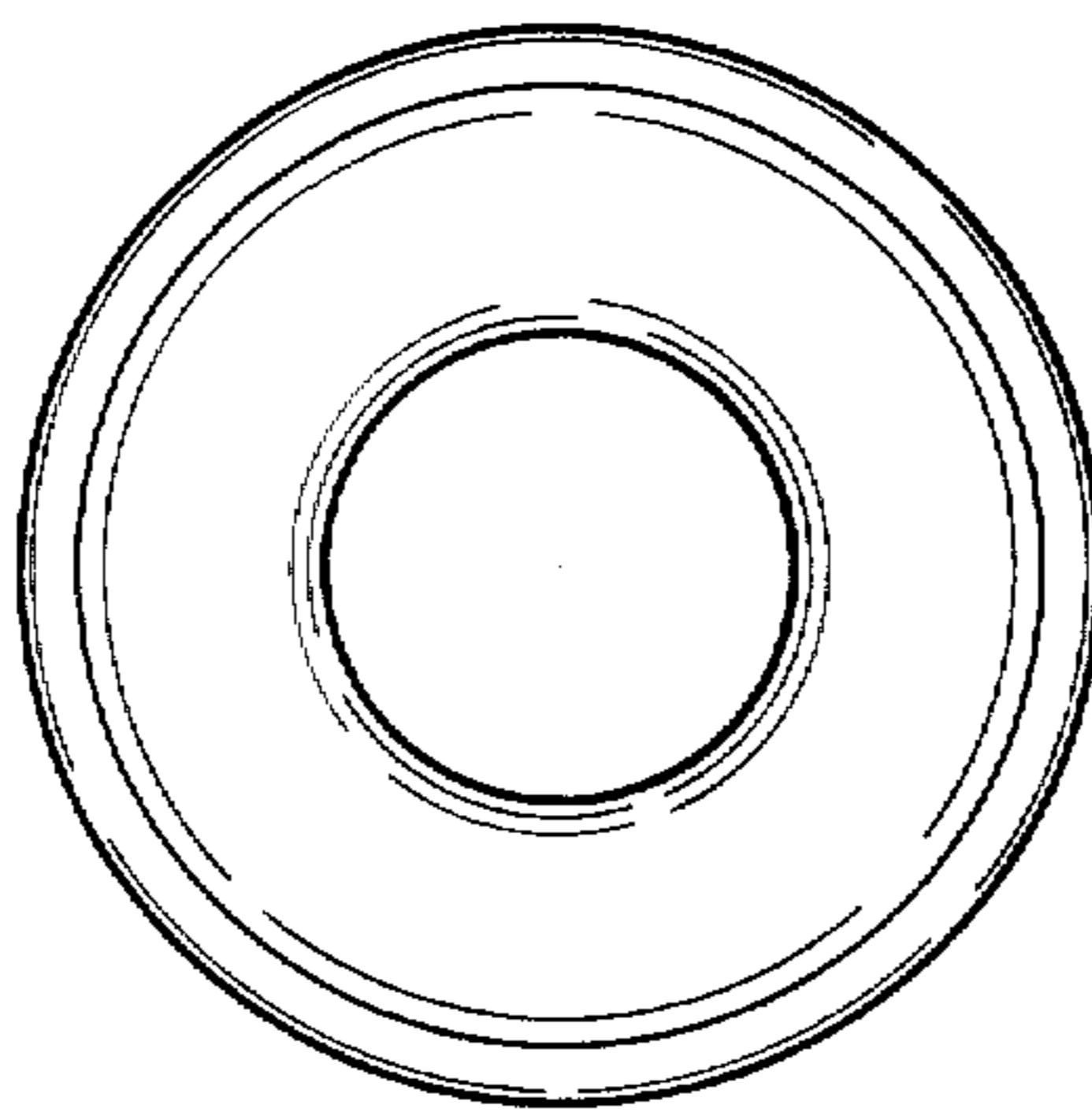

FIG.7

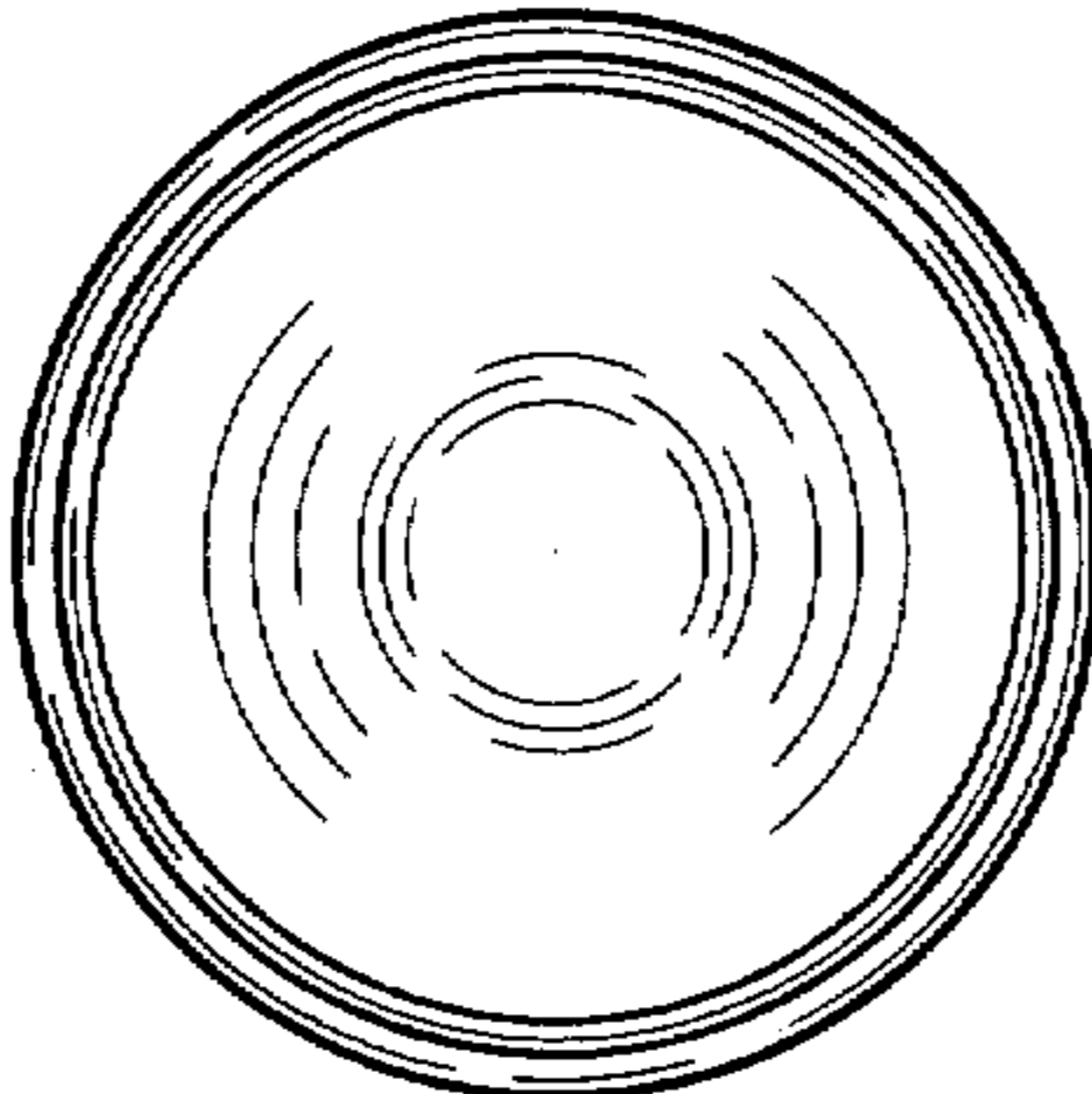

FIG. 8

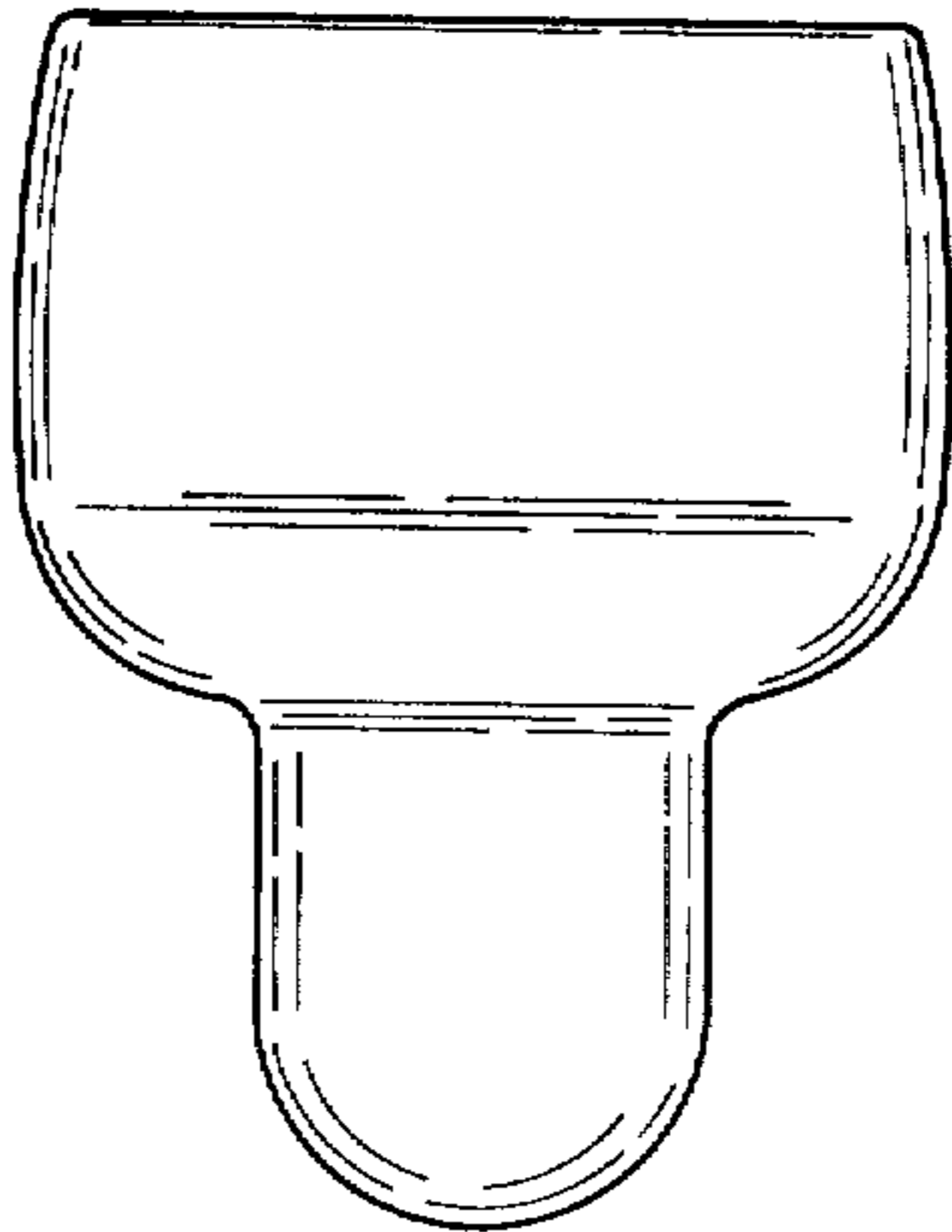

FIG. 9

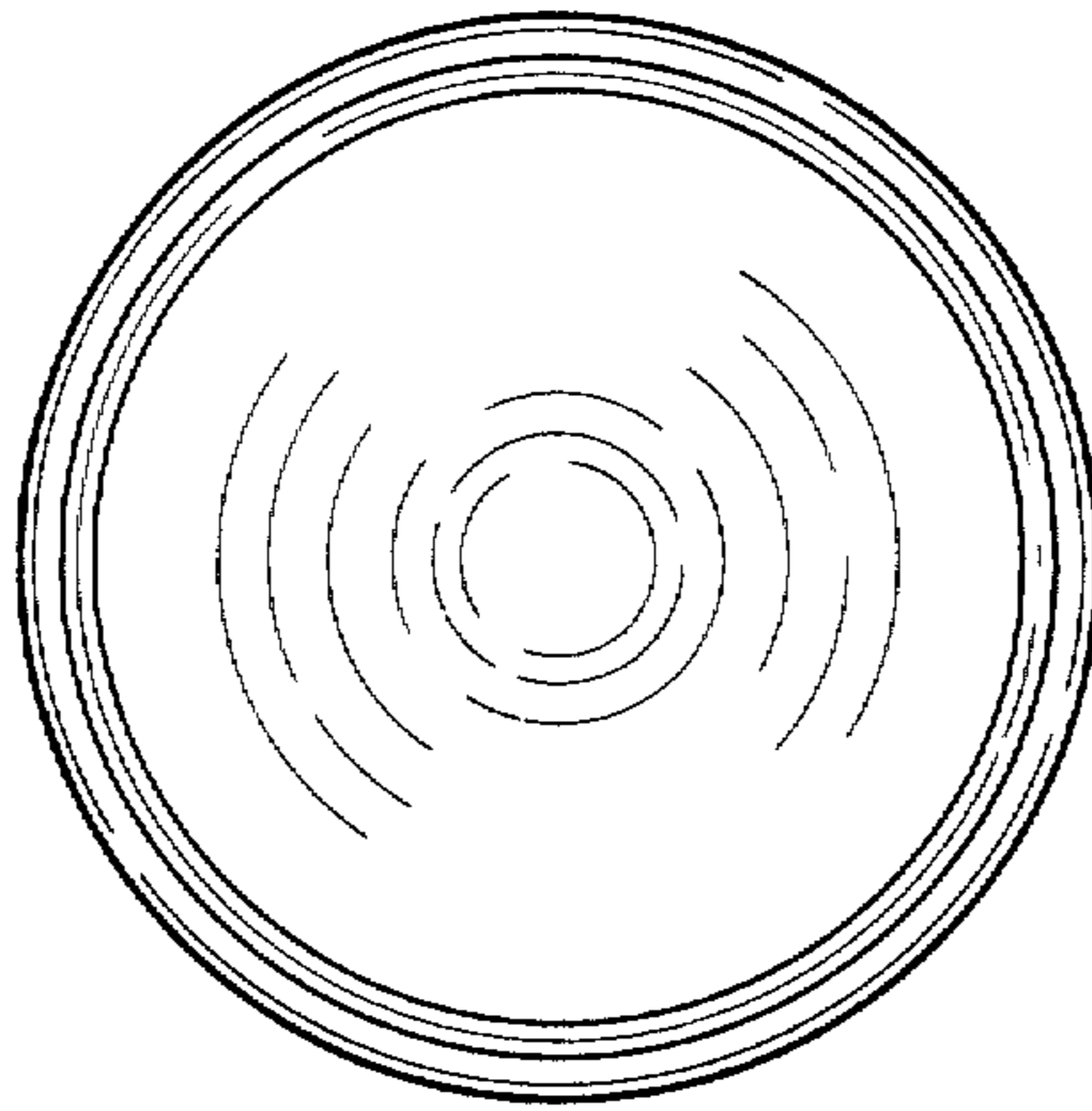

FIG. 10

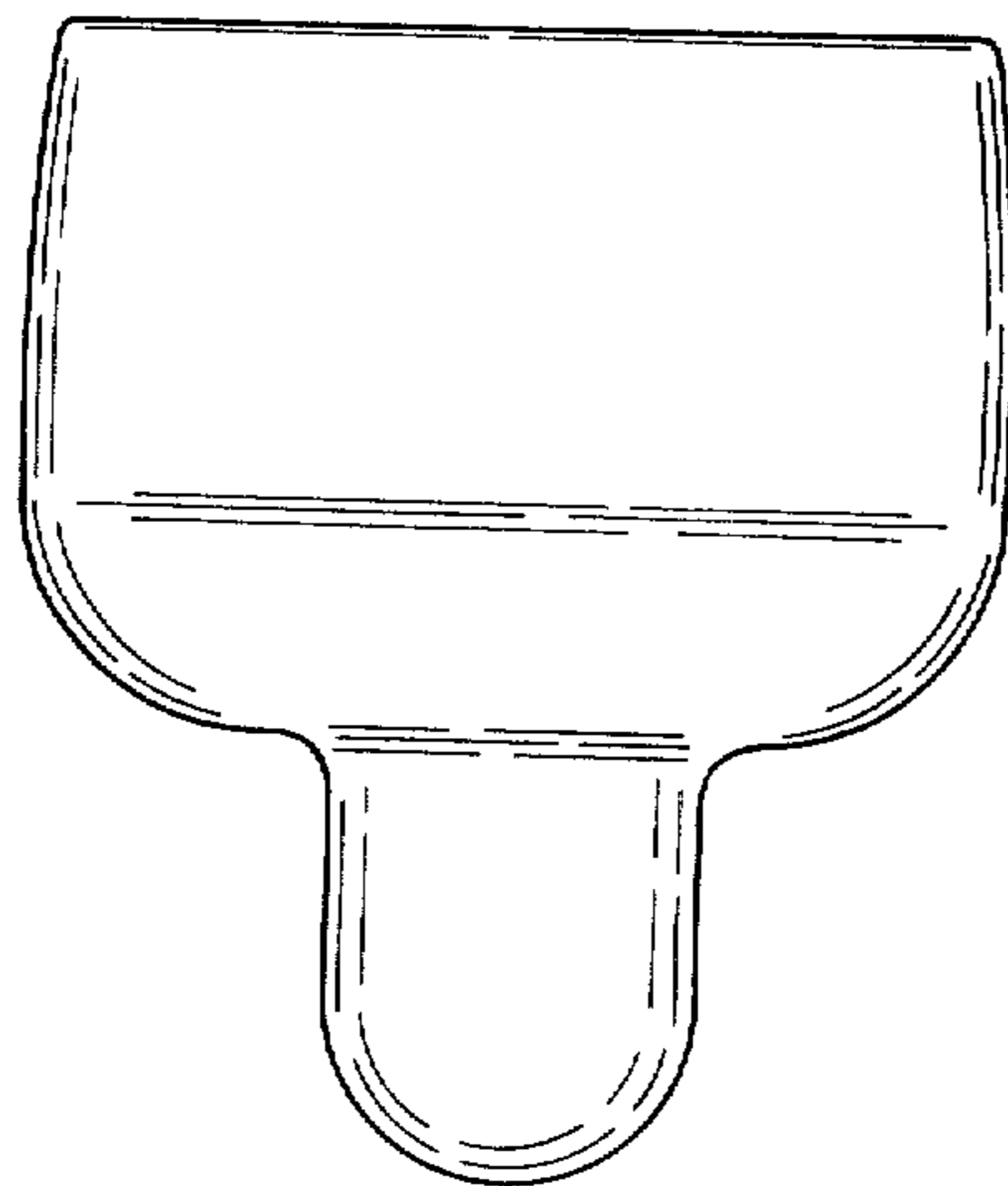

FIG. 11

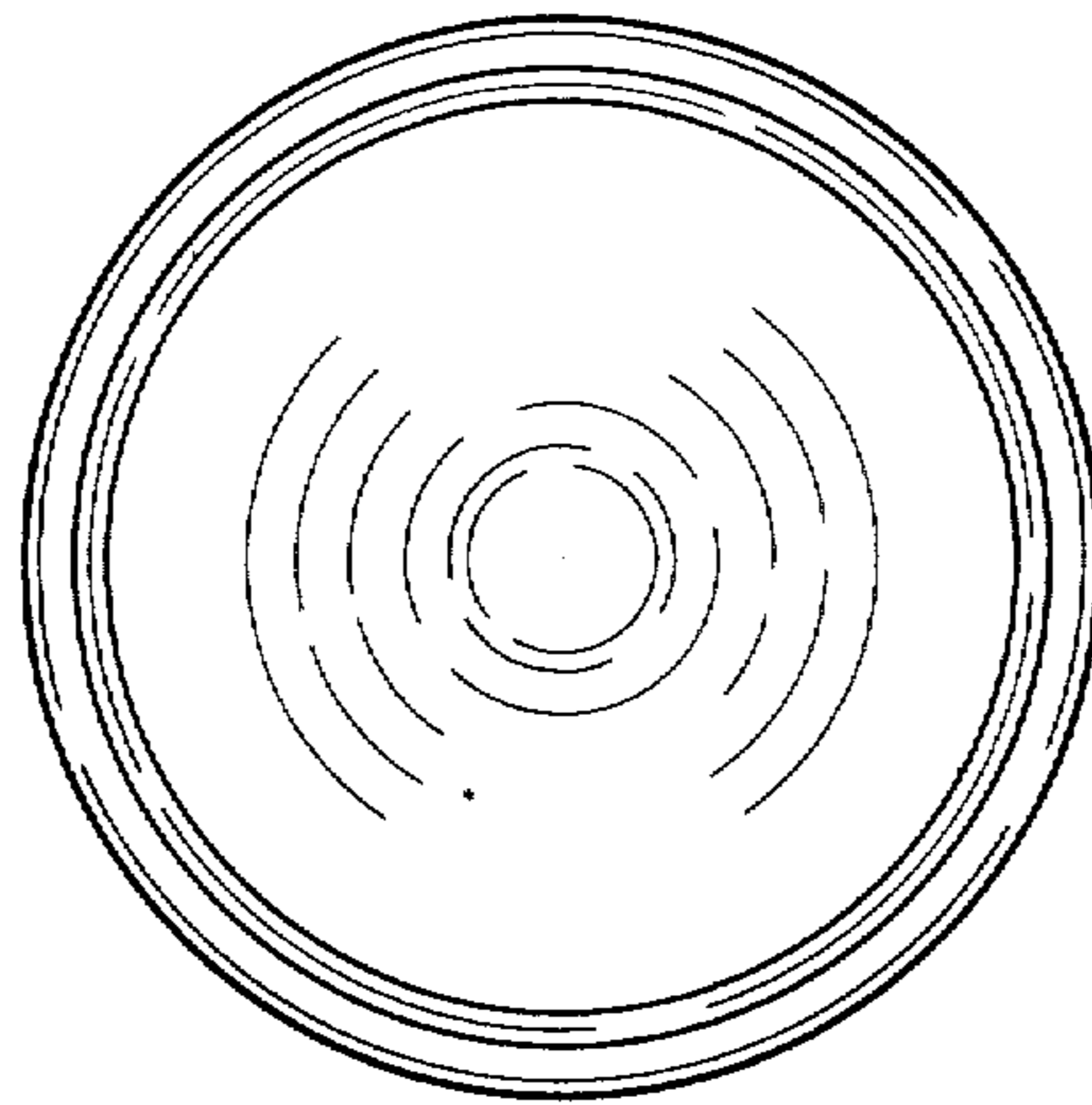

FIG. 12

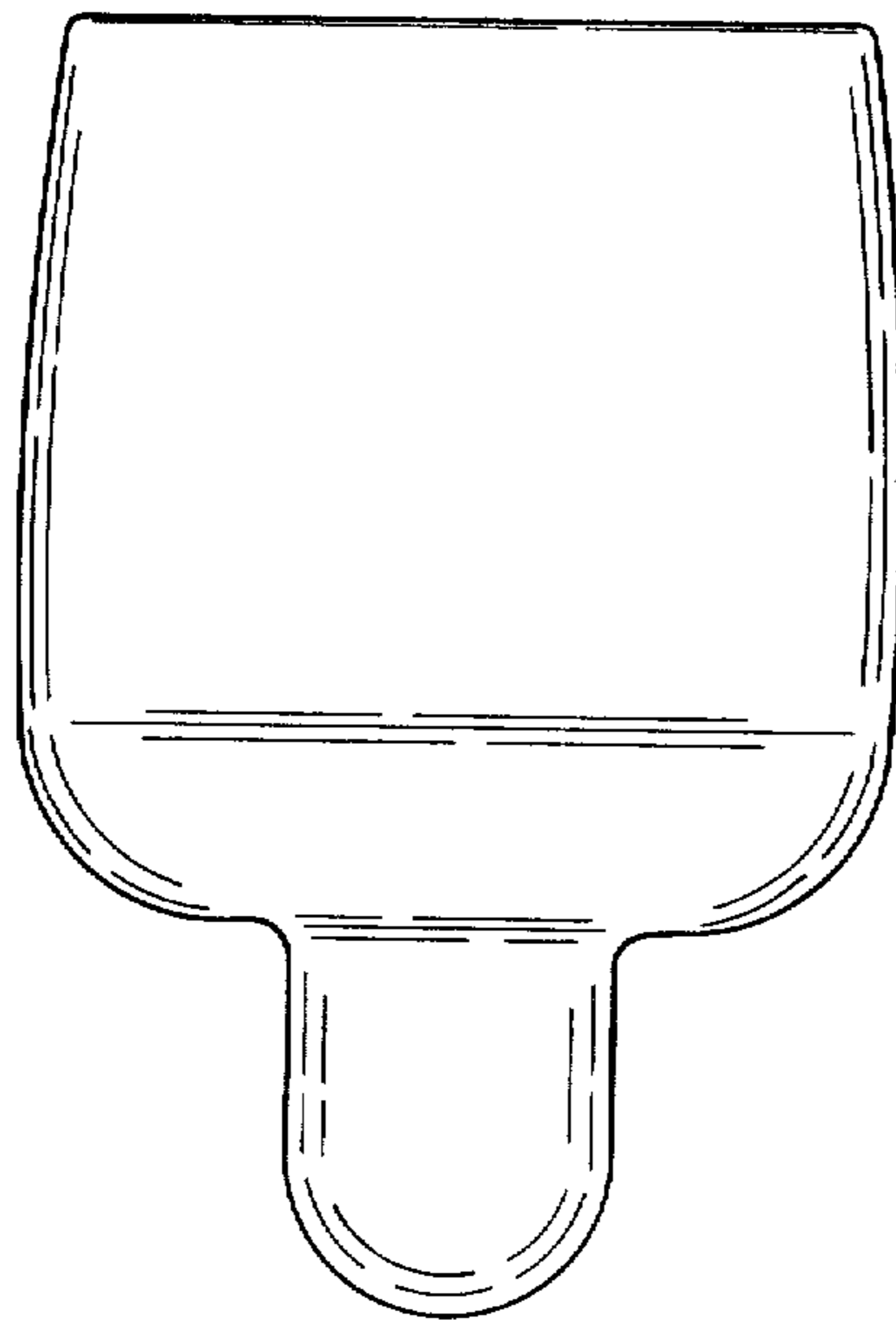

FIG. 13