

[54] SEWING CABINET

[75] Inventor: Sidney A. Lenger, Jr., Jamestown, N.C.

[73] Assignee: The Singer Company, Stamford, Conn.

[**] Term: 14 Years

[21] Appl. No.: 73,344

[22] Filed: Sep. 7, 1979

[51] Int. Cl. D06-04

[52] U.S. Cl. D6/40; D6/169

[58] Field of Search D6/40, 85, 154, 153, D6/158, 159, 164, 160, 163, 165, 166, 167, 168, 169, 170, 172, 174, 127, 128, 129, 145, 181, 186; D15/66, 78; D3/18, 20; 312/21, 22, 23, 237, 239, 282, 312, 313, 314, 315

[56] References Cited

U.S. PATENT DOCUMENTS

- D. 140,702 3/1945 Twente D6/40
- 1,195,964 8/1916 Bradley 312/314
- 1,700,924 2/1929 Cushman .
- 2,566,256 8/1951 Snyder 312/315

FOREIGN PATENT DOCUMENTS

- 47-356457 9/1972 Japan .

- 48-370479 7/1973 Japan .
- 50-407022 5/1975 Japan .
- 53-485198 6/1978 Japan .
- 53-485199 6/1978 Japan .
- 53-485200 6/1978 Japan .

OTHER PUBLICATIONS

"Modern" by Henredon; backcover, enclosed Cabinet.

Primary Examiner—Joel Stearman

Assistant Examiner—Carmen H. Vales

Attorney, Agent, or Firm—James M. Trygg; Robert E. Smith; Edward L. Bell

[57] CLAIM

The ornamental design for a sewing cabinet, substantially as shown and described.

DESCRIPTION

FIG. 1 is a perspective view of a sewing cabinet showing my new design;

FIG. 2 is a perspective view of a sewing cabinet with the top front doors open and the supporting platform extended;

FIG. 3 is a left side elevational view thereof;

FIG. 4 is a right side elevational view thereof;

FIG. 5 is a top plan view thereof;

FIG. 6 is a front elevational view thereof;

FIG. 7 is a rear elevational view thereof; and

FIG. 8 is a bottom plan view thereof.

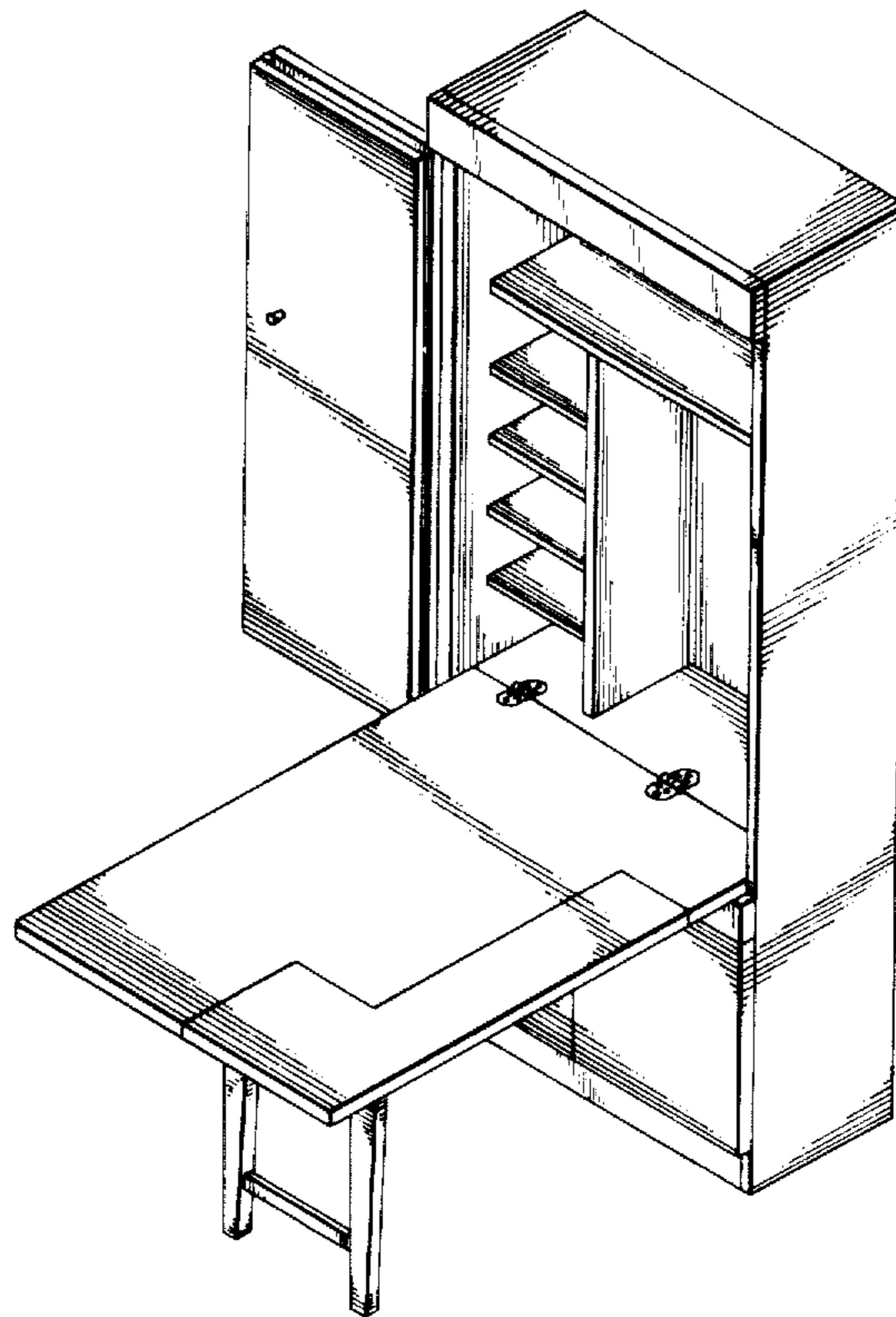

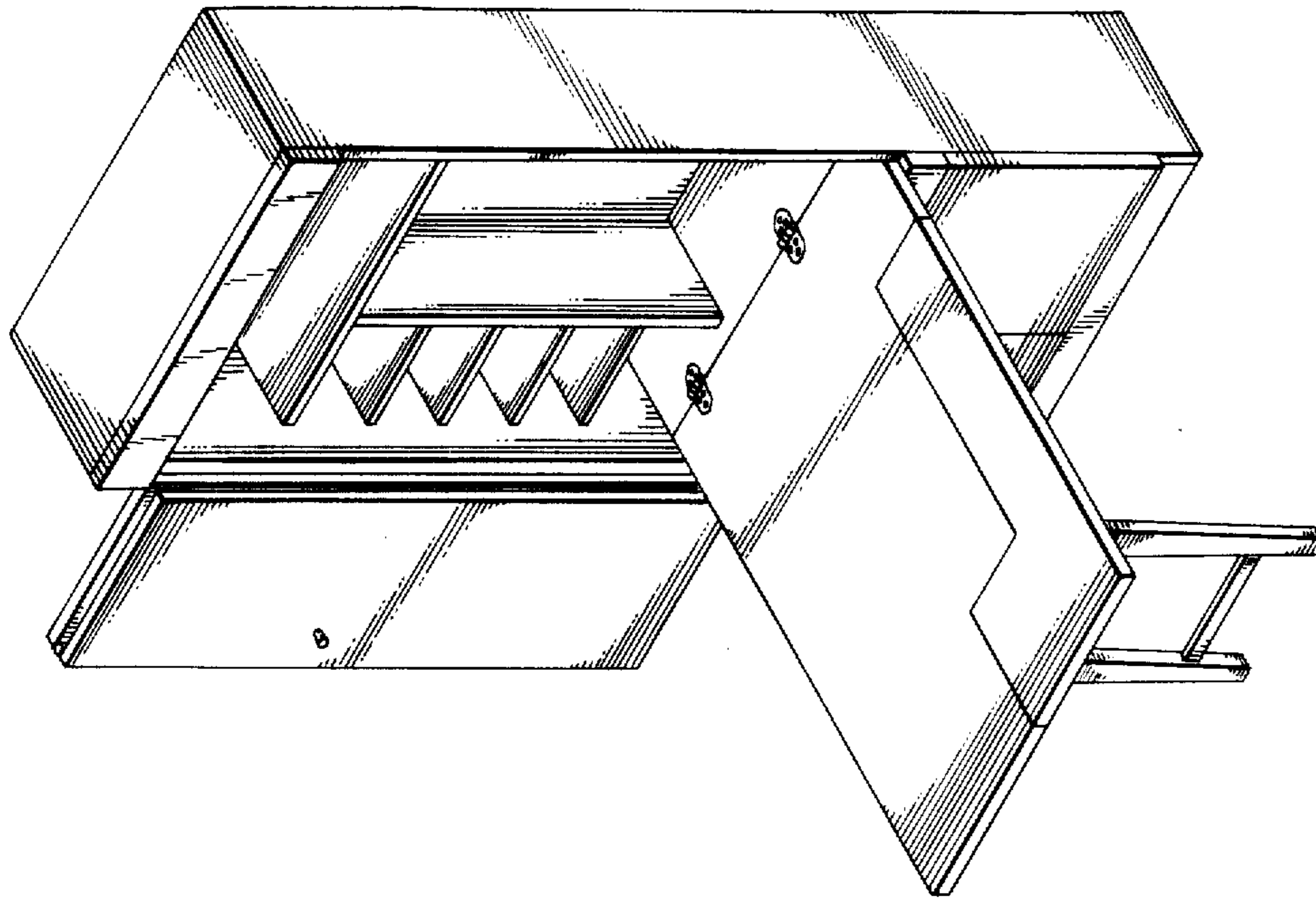

Fig. 2.

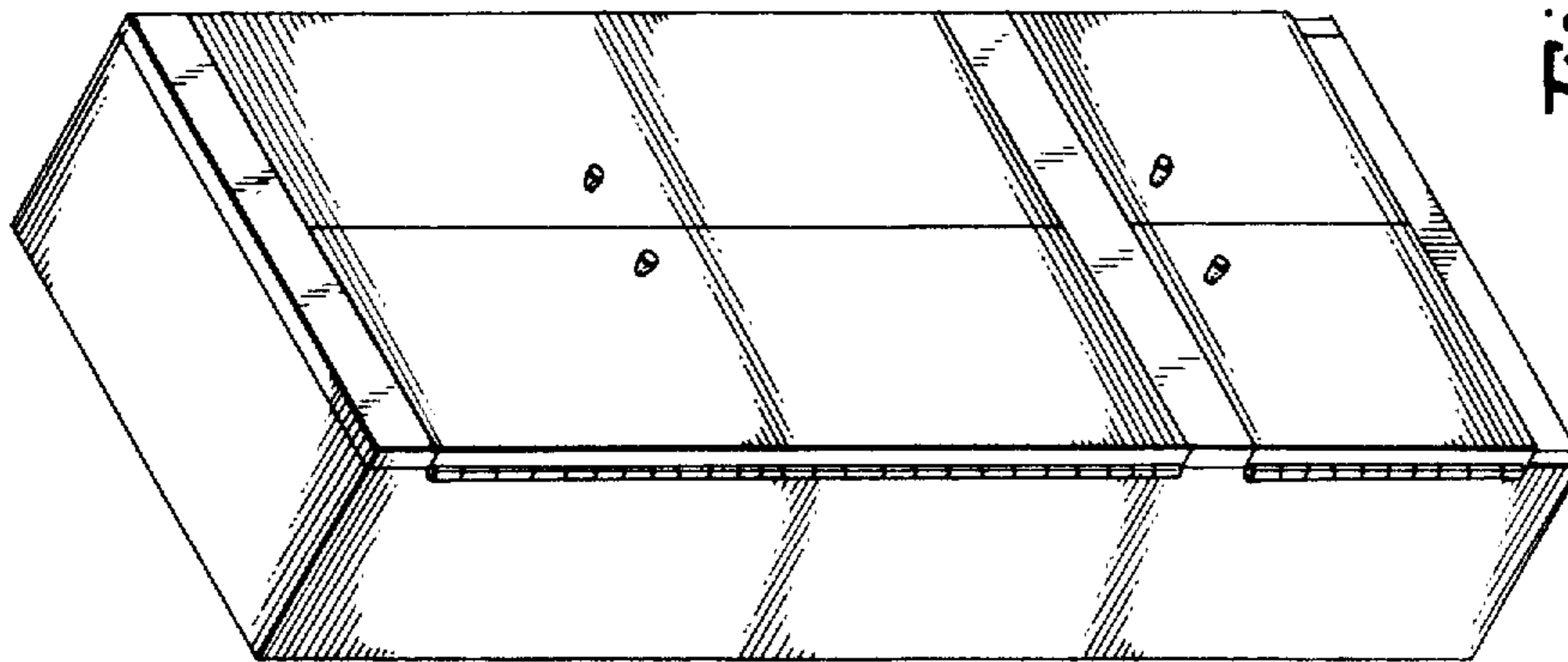

Fig. 1.

Fig. 3.

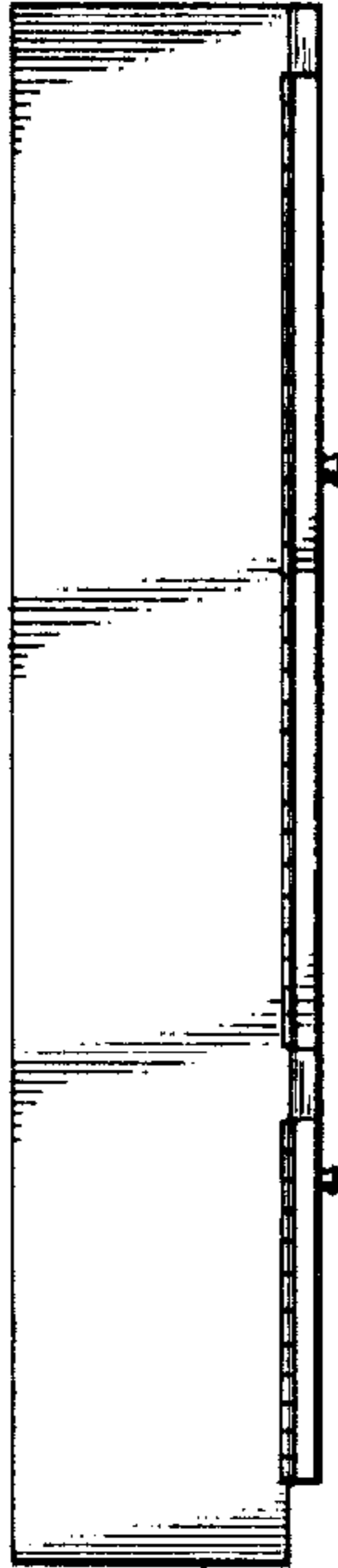

Fig. 4.

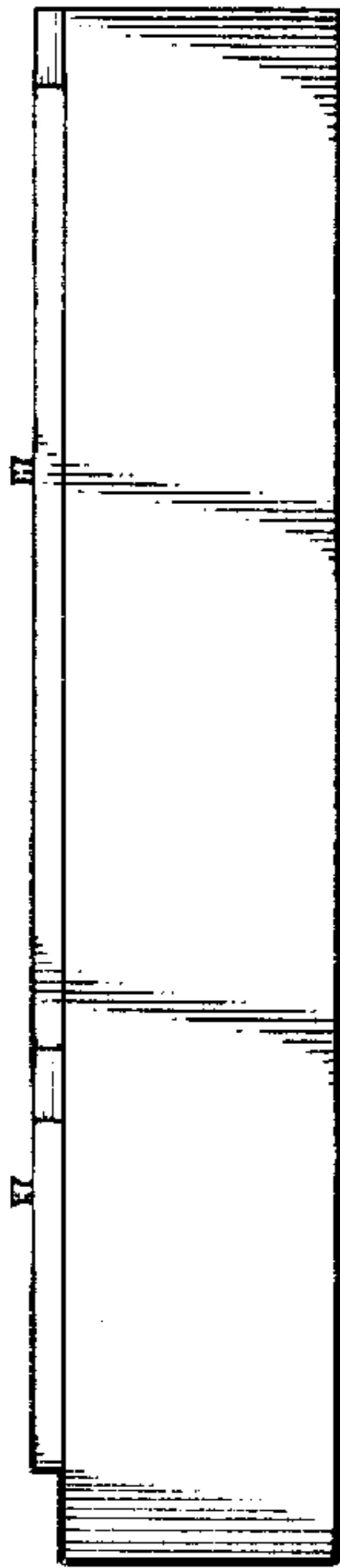

Fig. 5.

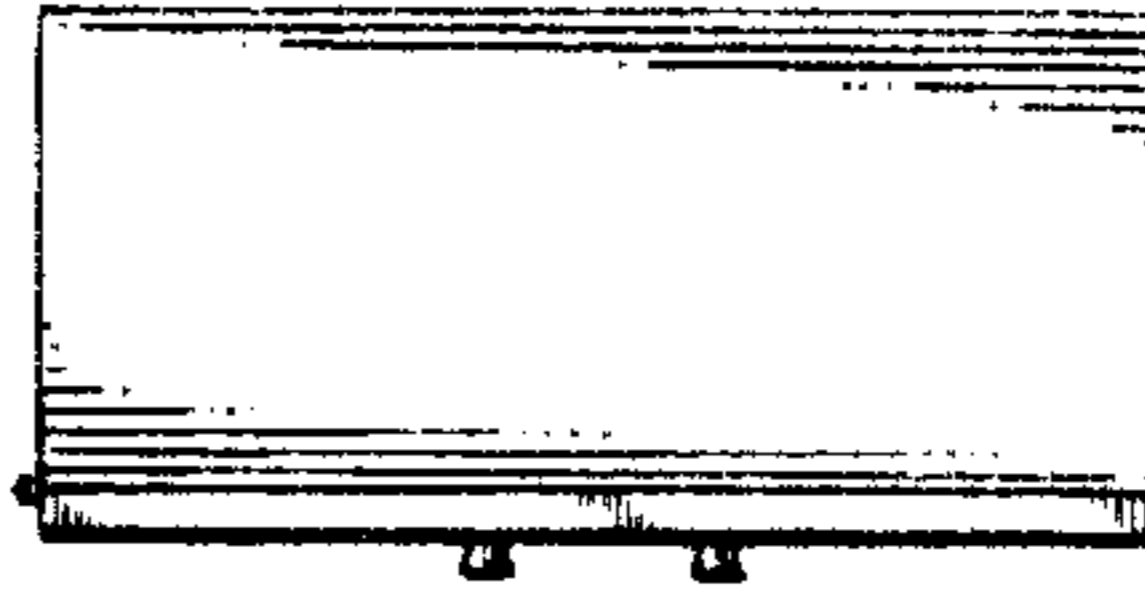

Fig. 6.

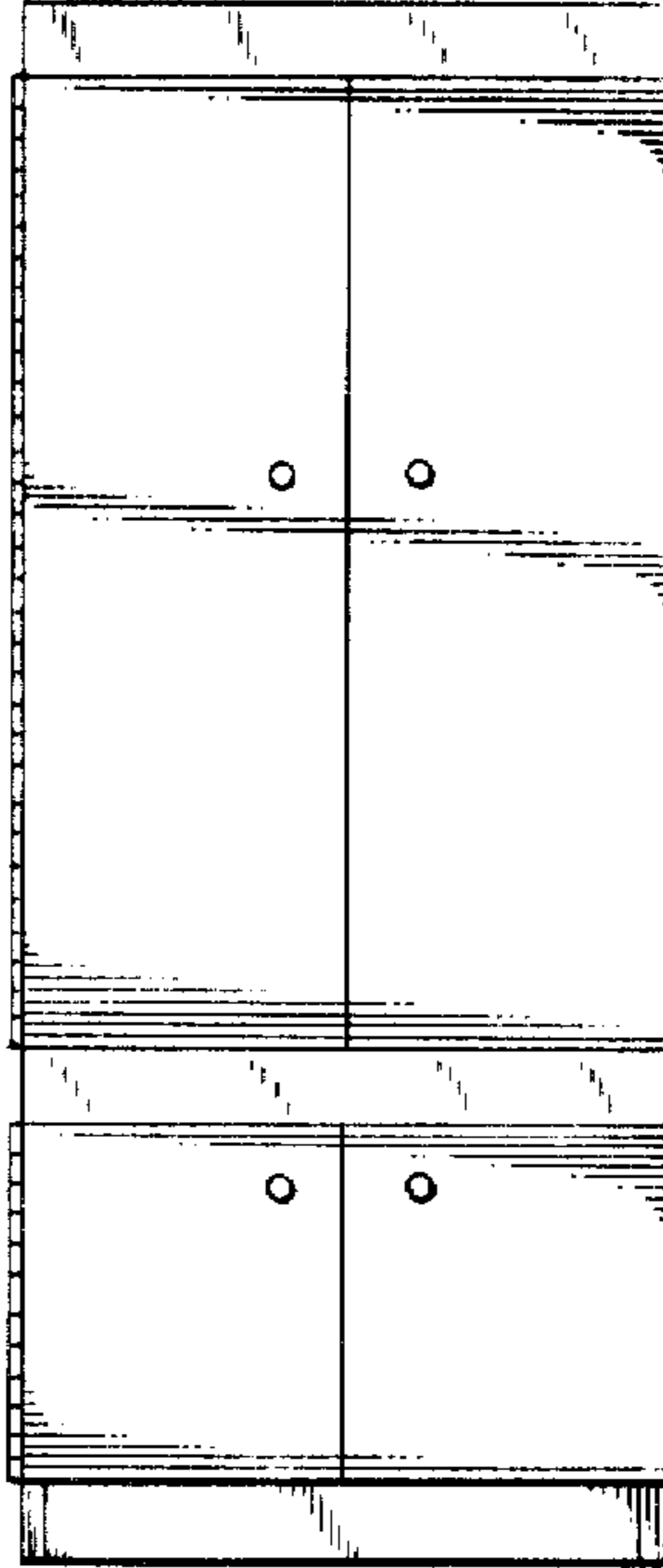

Fig. 7.

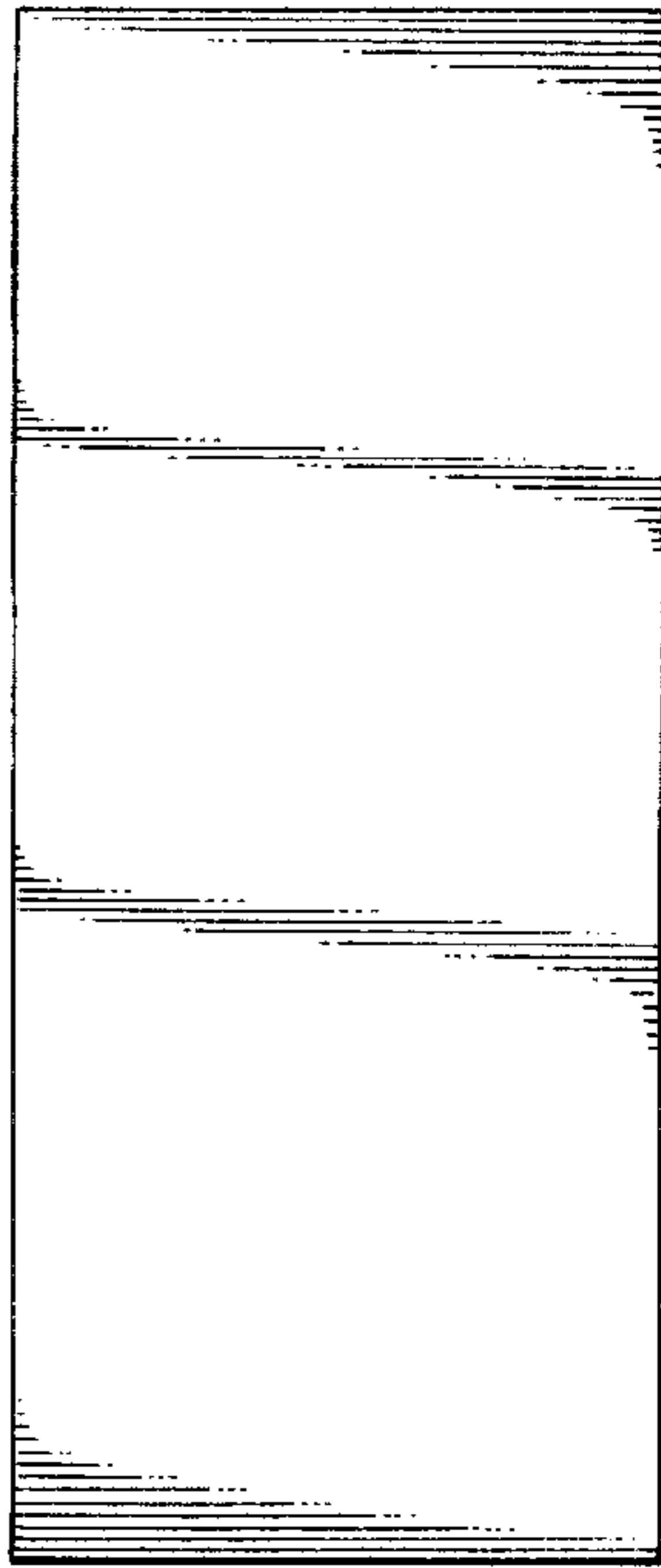

Fig. 8.

