

- [54] **FACIAL BUBBLE BATH**
- [75] Inventor: **Tsugio Akita, Osaka, Japan**
- [73] Assignee: **Matsushita Electric Industrial Co., Ltd., Kadoma, Japan**
- [\*\*] Term: **14 Years**
- [21] Appl. No.: **88,914**
- [22] Filed: **Oct. 29, 1979**
- [30] **Foreign Application Priority Data**  
 May 16, 1979 [JP] Japan ..... 54-19805
- [51] Int. Cl. .... **D23—02**
- [52] U.S. Cl. .... **D23/48; D24/36; D28/9**
- [58] Field of Search ..... **D23/48, 51, 146, 148; D24/36, 37, 38, 40, 41; D28/9, 99; D29/7; 4/524, 525, 533, 534, 537; 128/66, 365, 367, 368; 219/271, 219/275**

- 2,824,208 2/1958 Bauer ..... D23/148 X
- 3,152,240 10/1964 Scott ..... D23/148 X

**OTHER PUBLICATIONS**

Breck's of Boston Catalogue, 1966, p. 61, Sauna in upper right.  
 Breck's of Boston Catalogue, 1967, p. 53, Facial Mist Applicator in upper center.

*Primary Examiner*—Leland A. Sebastian  
*Attorney, Agent, or Firm*—Sughrue, Mion, Zinn, Macpeak and Seas

**CLAIM**

[57] The ornamental design for a facial bubble bath, substantially as shown.

**DESCRIPTION**

FIG. 1 is a front perspective view of a facial bubble bath showing my new design;  
 FIG. 2 is a rear perspective view thereof;  
 FIG. 3 is a front elevational view thereof;  
 FIG. 4 is a rear elevational view thereof;  
 FIG. 5 is a left side elevational view thereof;  
 FIG. 6 is a right side elevational view thereof;  
 FIG. 7 is a top plan view thereof; and  
 FIG. 8 is a bottom plan view thereof.

[56] **References Cited**

**U.S. PATENT DOCUMENTS**

- D. 208,514 9/1967 Hartwell ..... D24/36
- D. 209,939 1/1968 Grube ..... D23/48

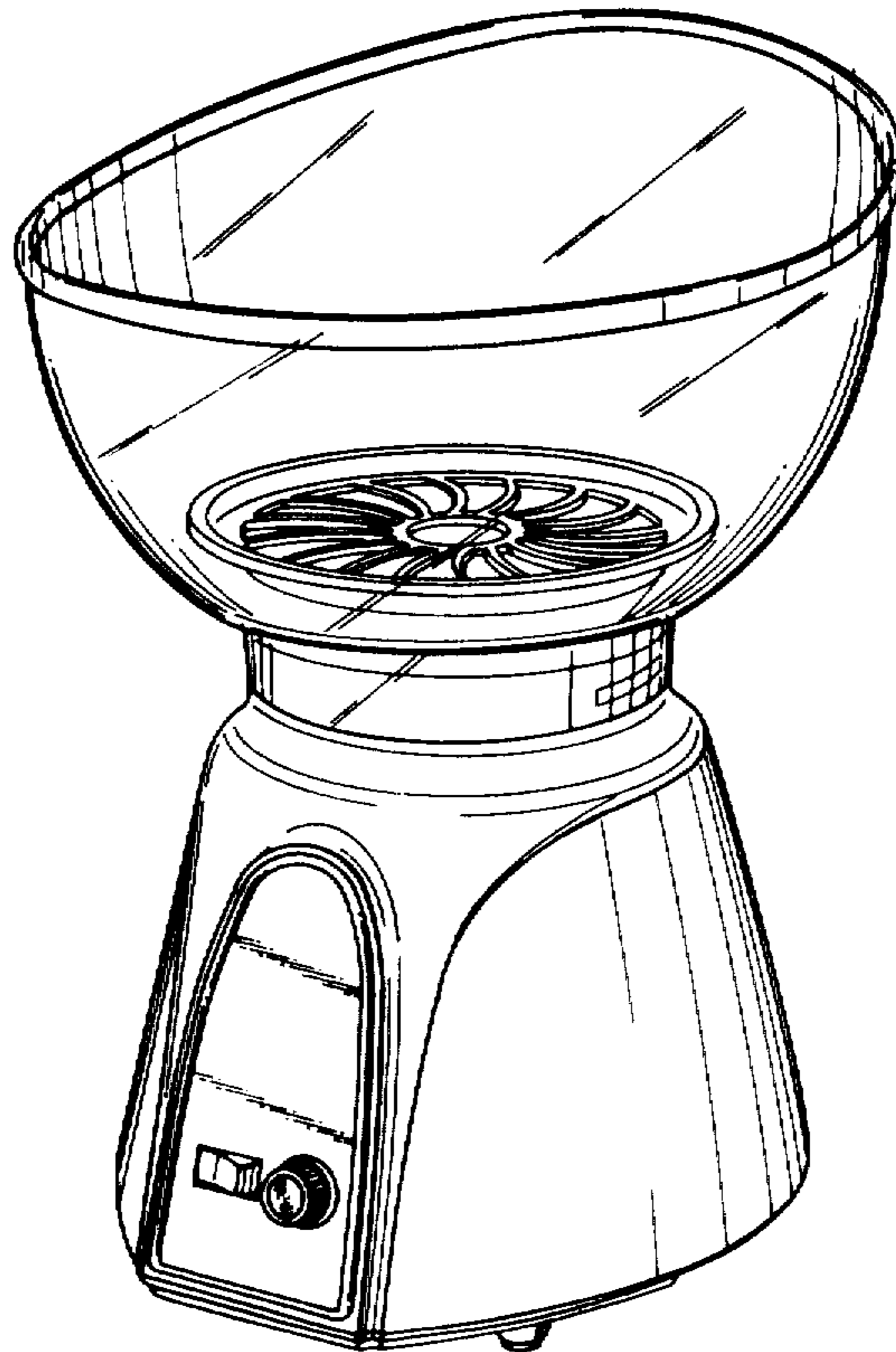

*Fig. 1*

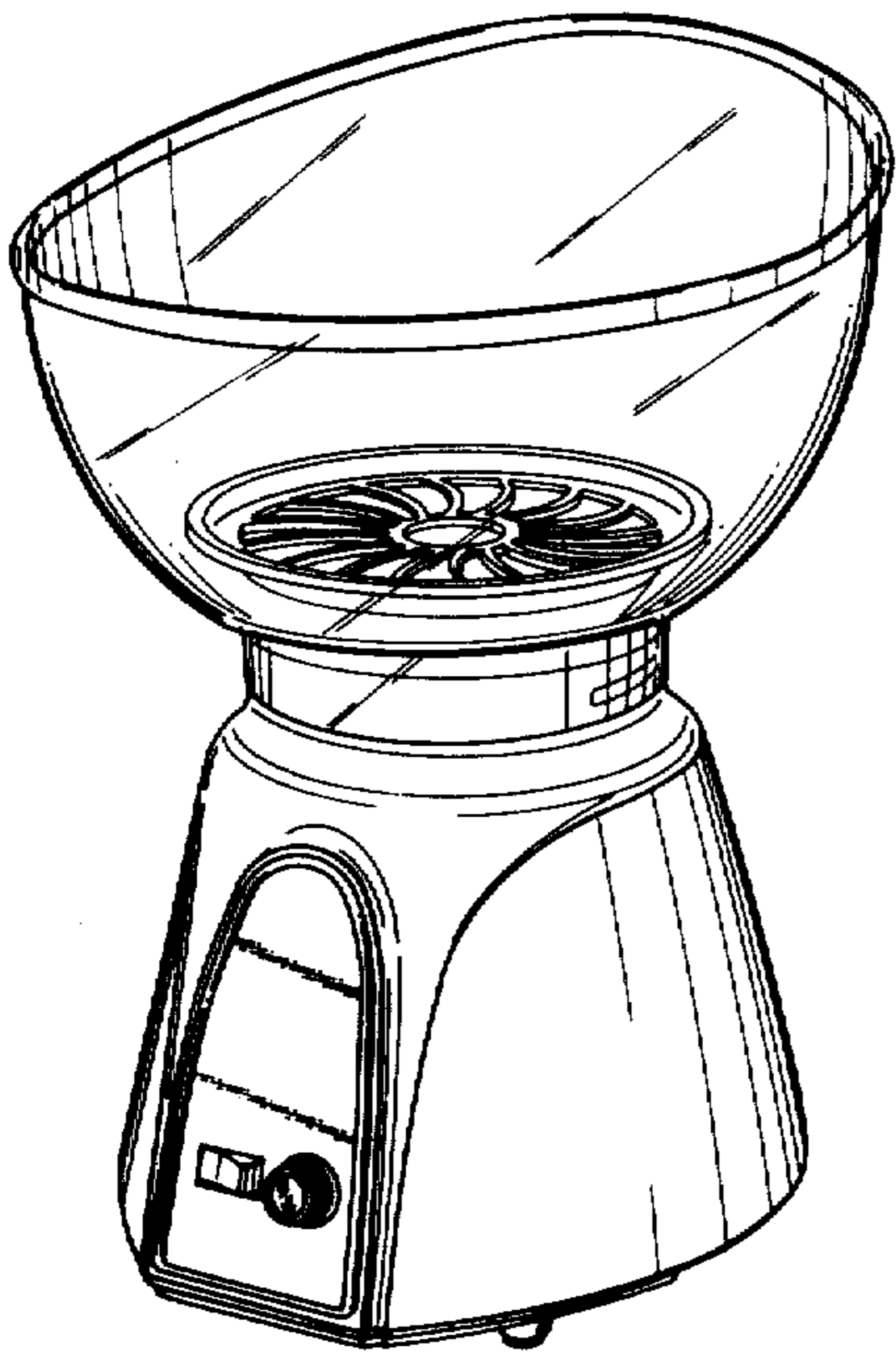

*Fig. 2*

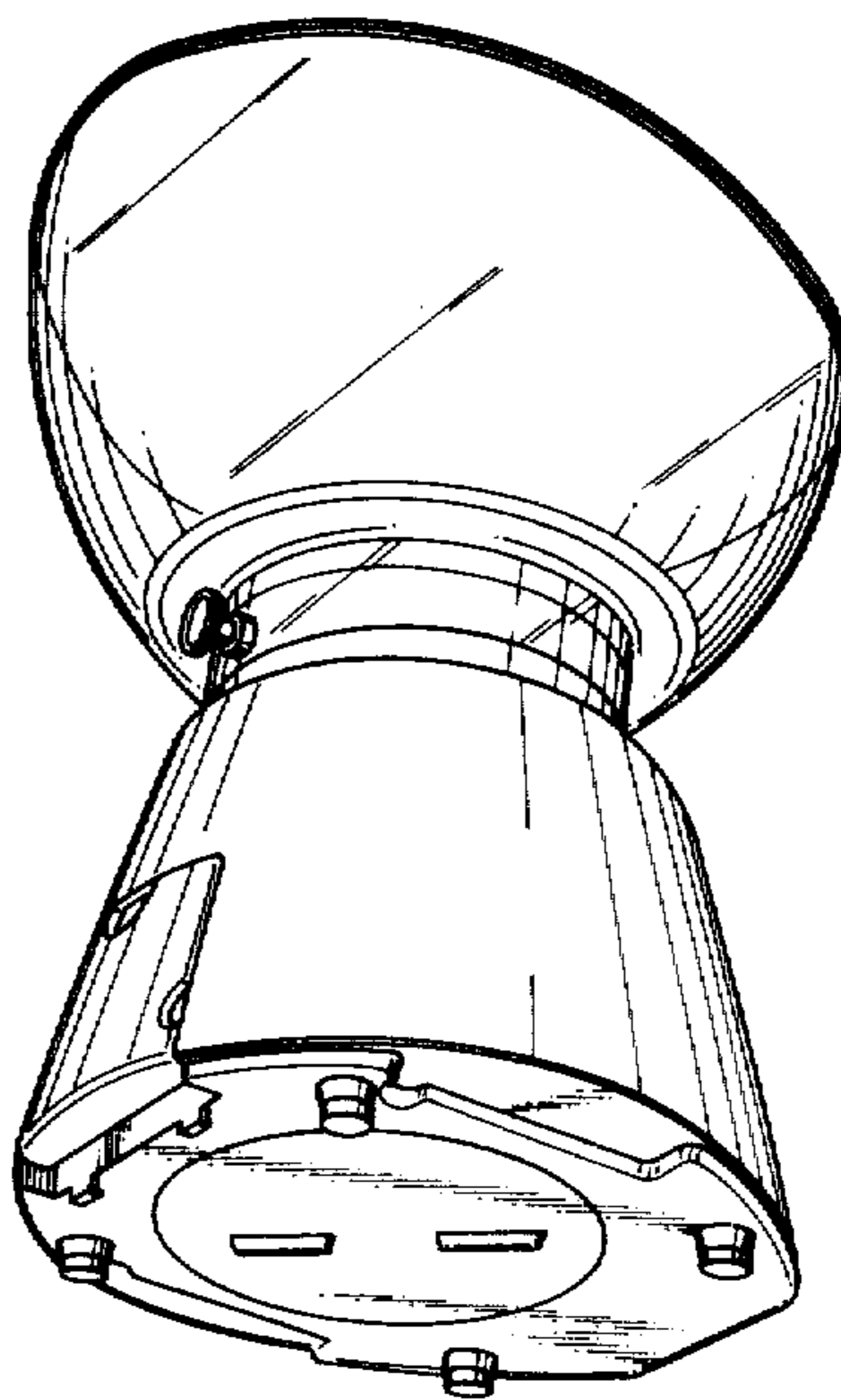

*Fig. 3*

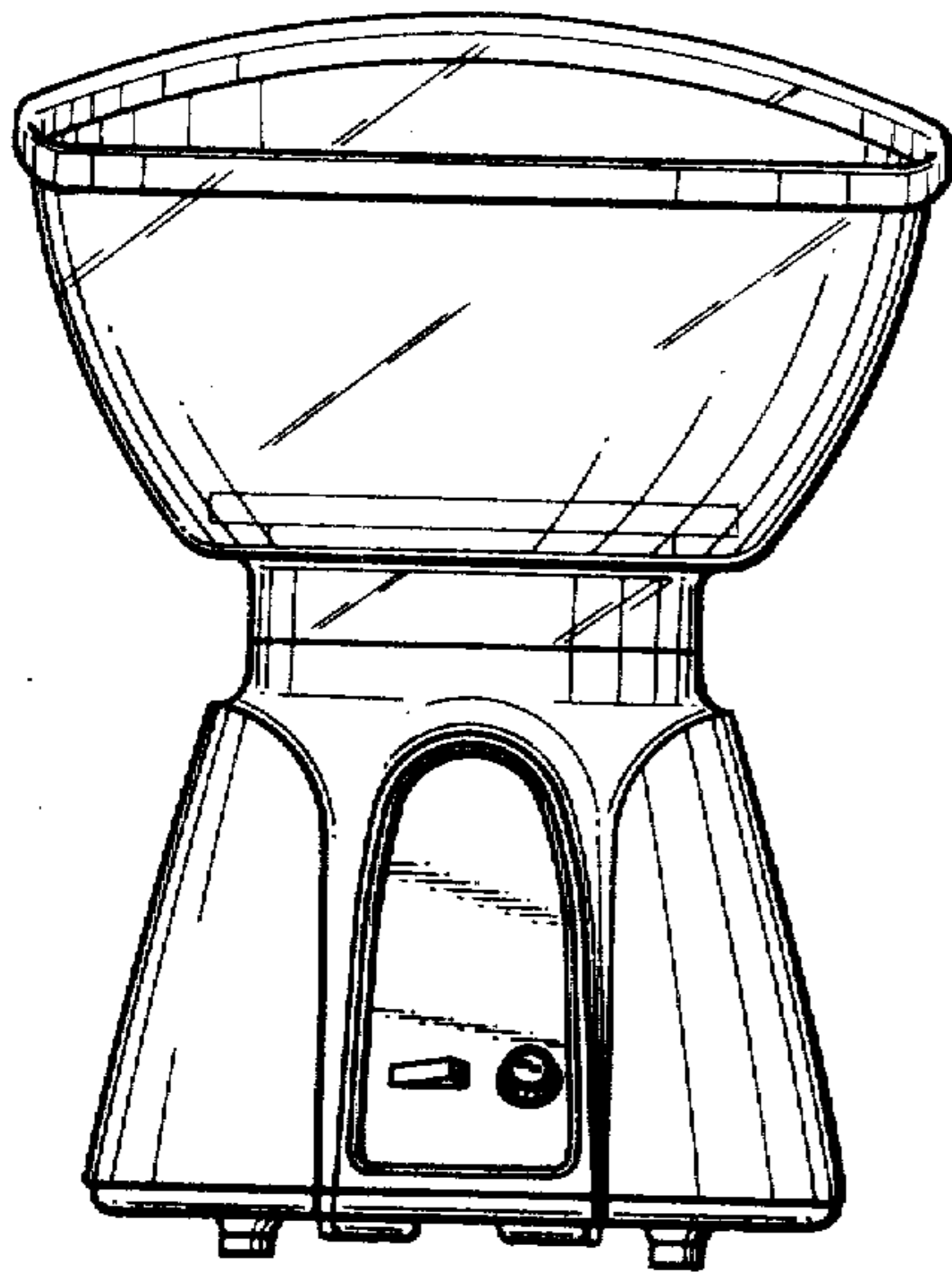

*Fig. 4*

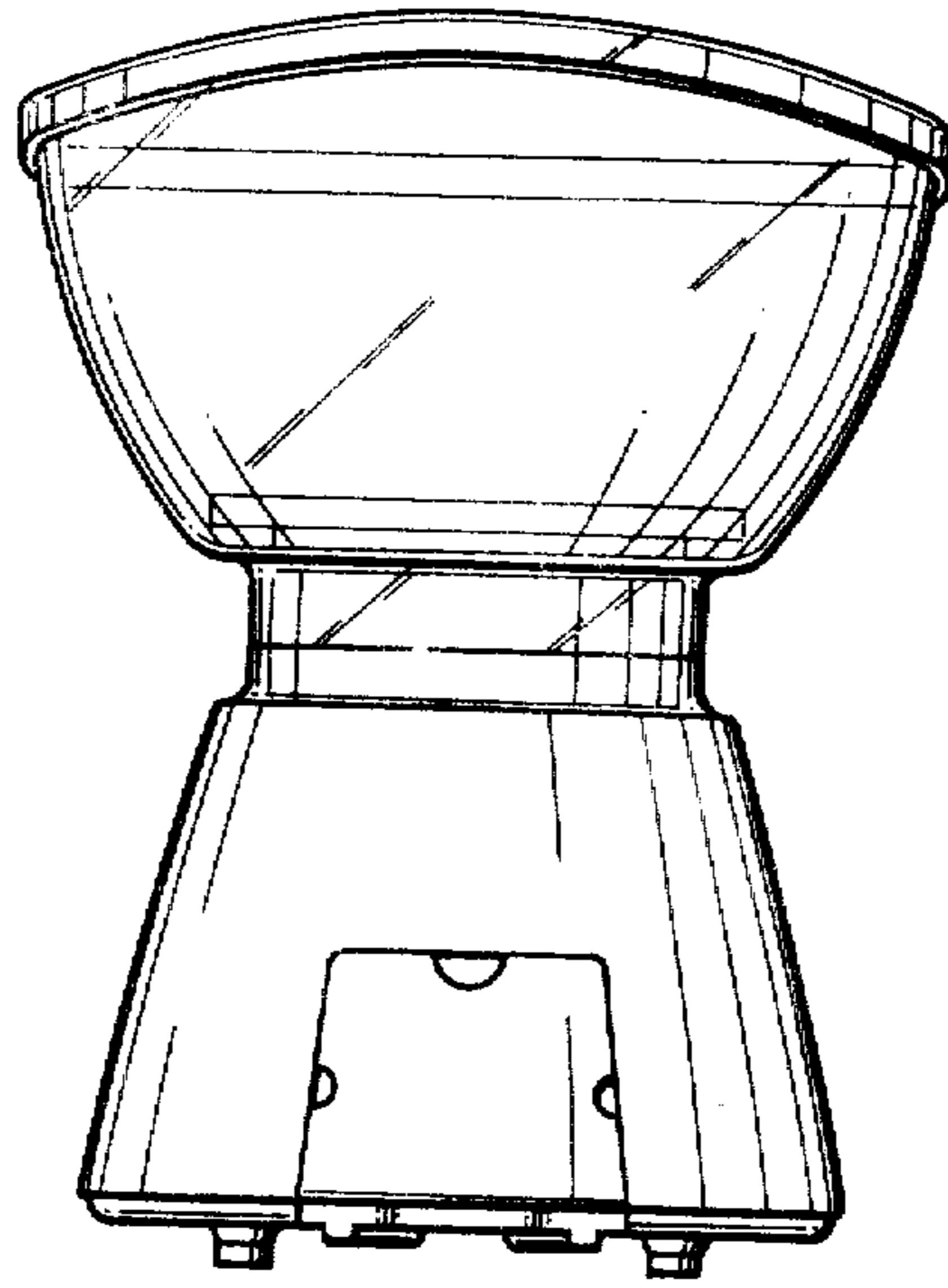

*Fig. 5*

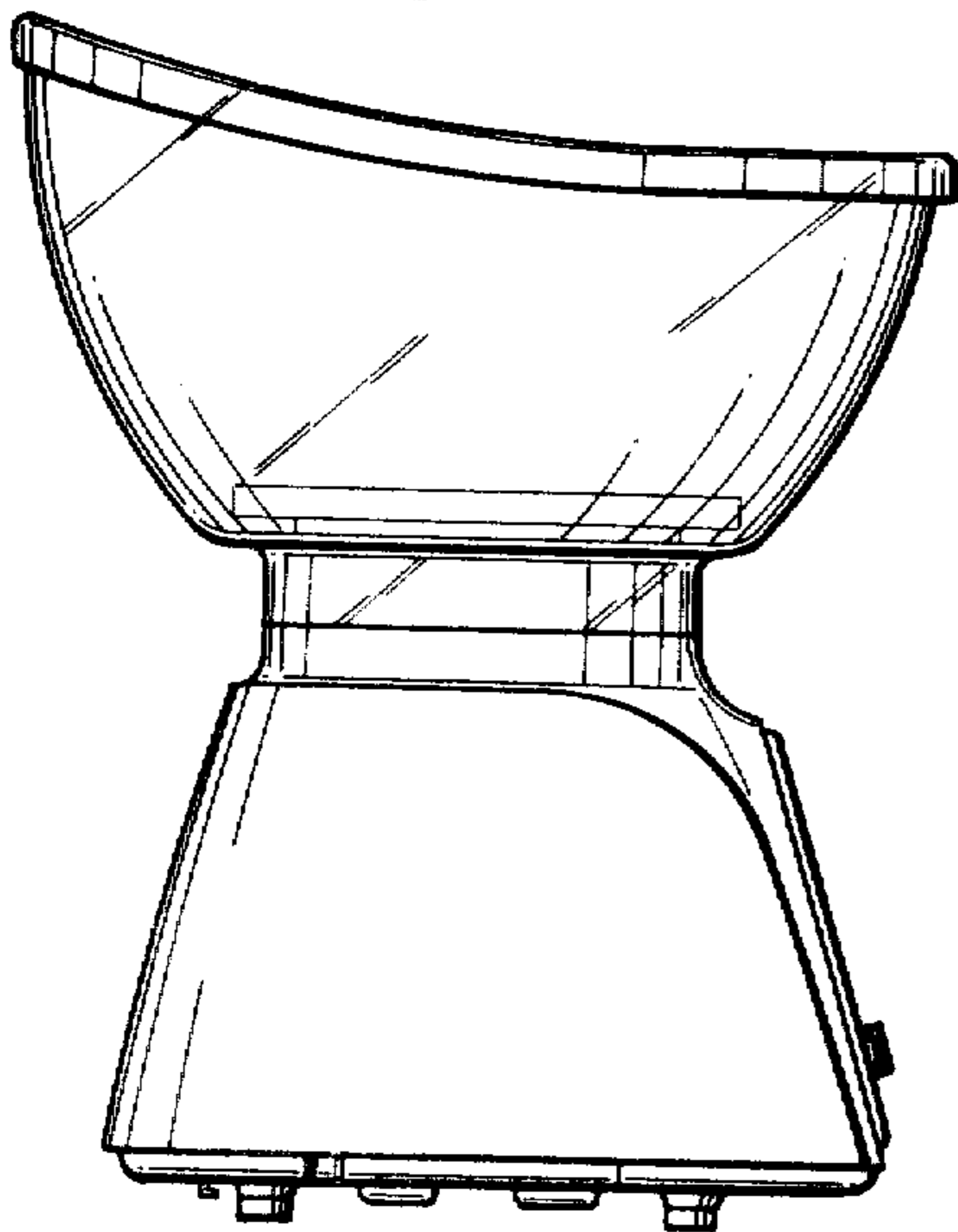

*Fig. 6*

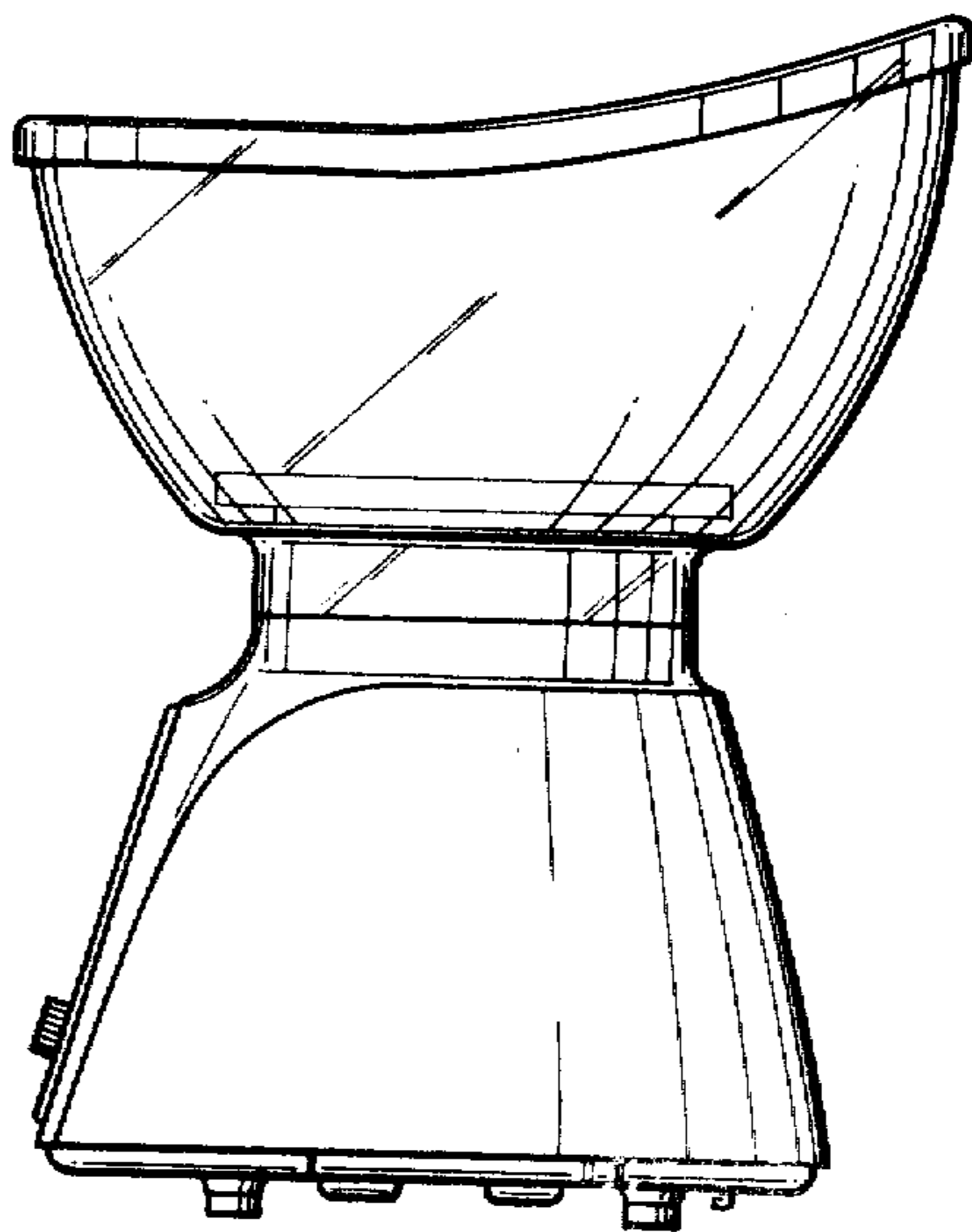

*Fig. 7*

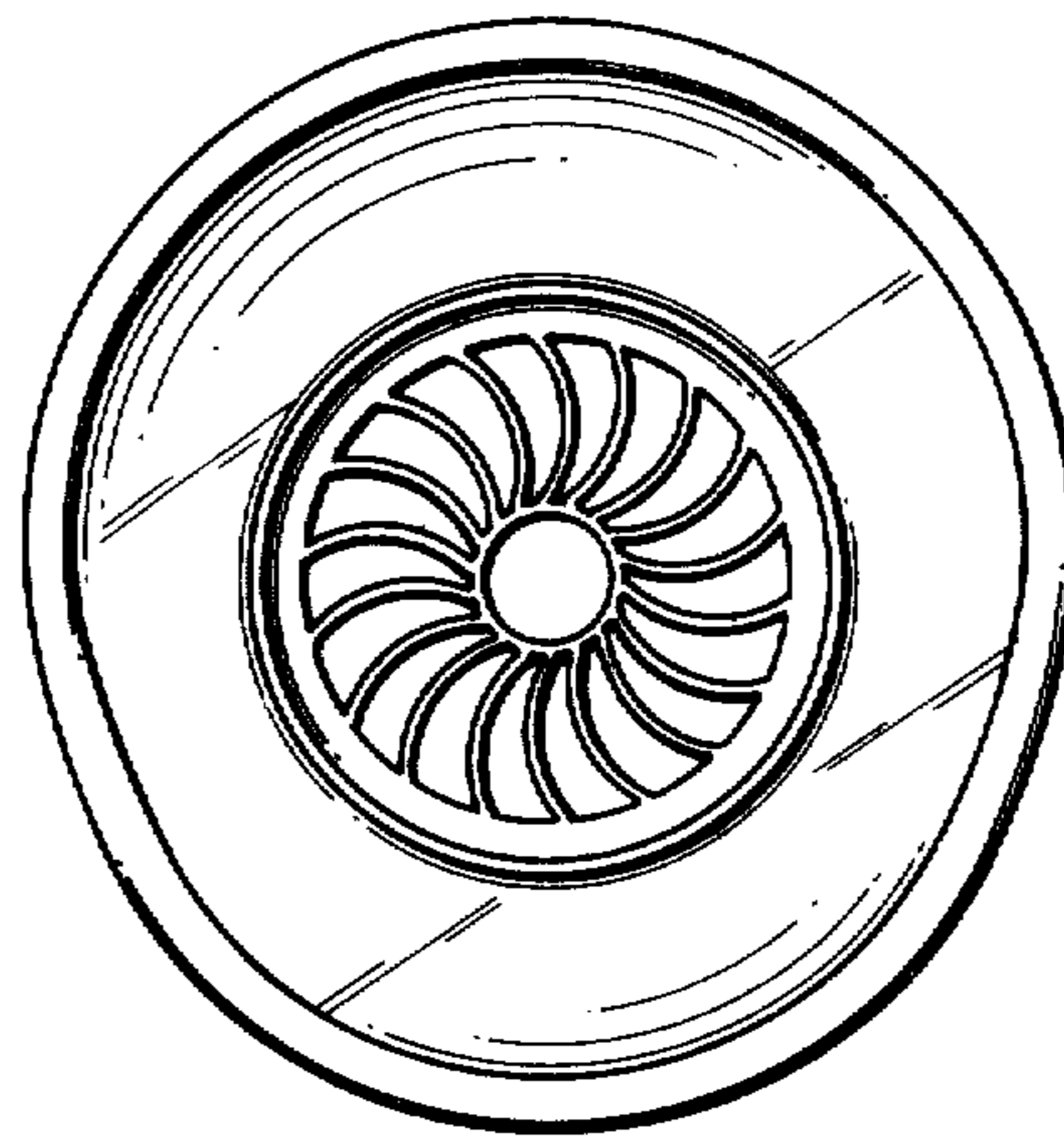

*Fig. 8*

