

[54] TYPEWRITER

D. 257,561 11/1980 Christie D18/1

[75] Inventor: Angelo M. LaBarbera, Liverpool, N.Y.

OTHER PUBLICATIONS

[73] Assignee: SCM Corporation, New York, N.Y.

Sears, Roebuck and Co., Fall/Winter 1978 Catalog, (Eastern Edition 257H) p. 1097, typewriter in bottom right corner.

[**] Term: 14 Years

The Washington Post, Thurs. Mar. 25, 1976, p. D17, Sears "Communicator 1", typewriter.

[21] Appl. No.: 103,823

[22] Filed: Dec. 14, 1979

Primary Examiner—Robert C. Spangler
Attorney, Agent, or Firm—William E. Mear, III; Milton M. Wolson; Ernest F. Weinberger

[51] Int. Cl. D18-01

[52] U.S. Cl. D18/1

[58] Field of Search D18/1, 2, 11, 12, 13; 400/689-694

[57] CLAIM

The ornamental design for a typewriter, as shown.

[56] References Cited

DESCRIPTION

U.S. PATENT DOCUMENTS

D. 230,510	2/1974	Sakow	D18/1
D. 230,638	3/1974	Baughman	D18/1
D. 231,263	4/1974	Dietrich	D18/1
D. 235,806	7/1975	Abend et al.	D18/1
D. 241,170	8/1976	Metzner	D18/1
D. 253,178	10/1979	Osit	D18/1

FIG. 1 is a front perspective view of a typewriter showing my new design;

FIG. 2 is a top plan view thereof;

FIG. 3 is a front elevational view thereof;

FIG. 4 is a rear elevational view thereof;

FIG. 5 is a bottom plan view thereof;

FIG. 6 is a right side elevational view thereof; and

FIG. 7 is a left side elevational view thereof.

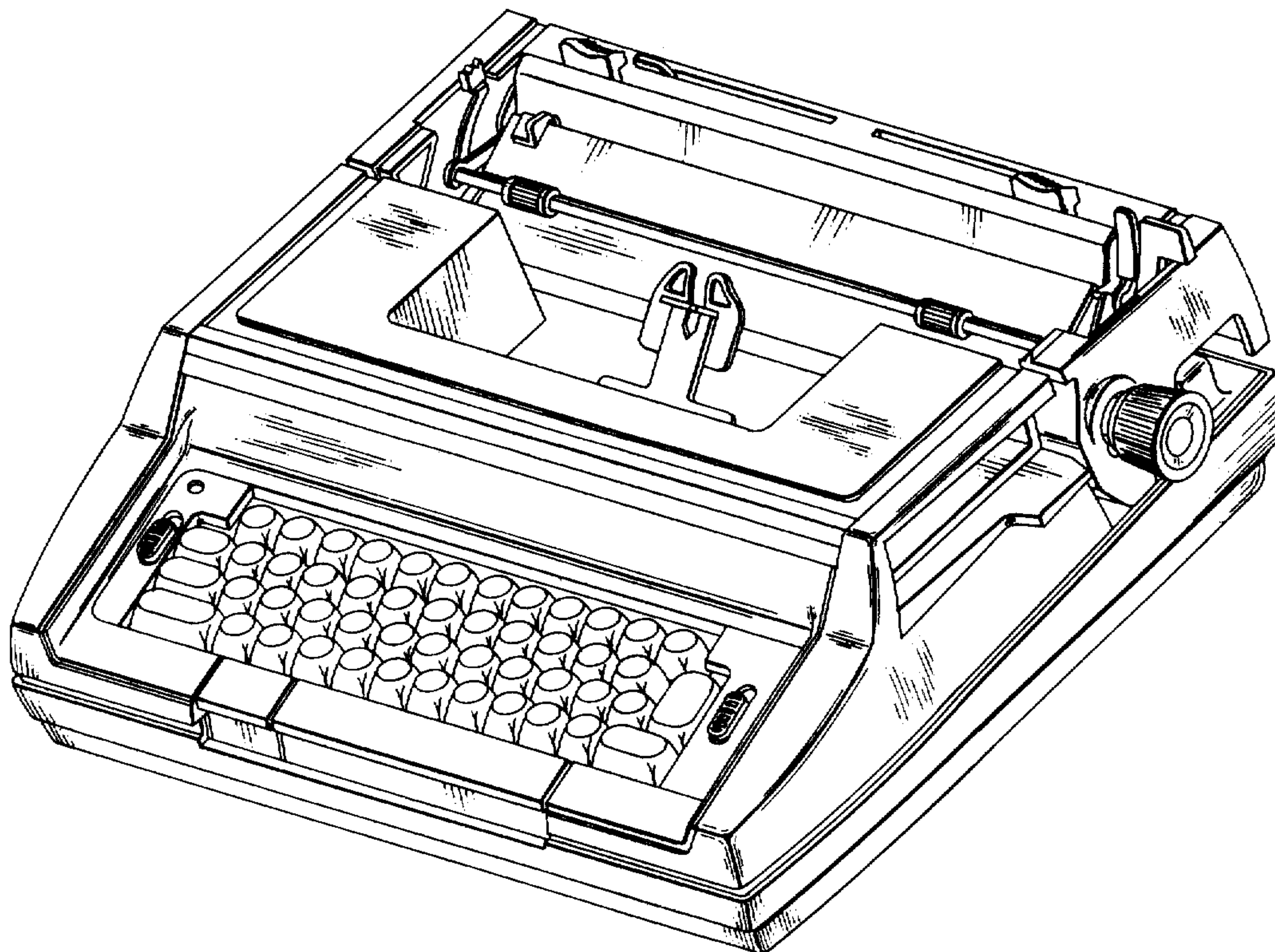

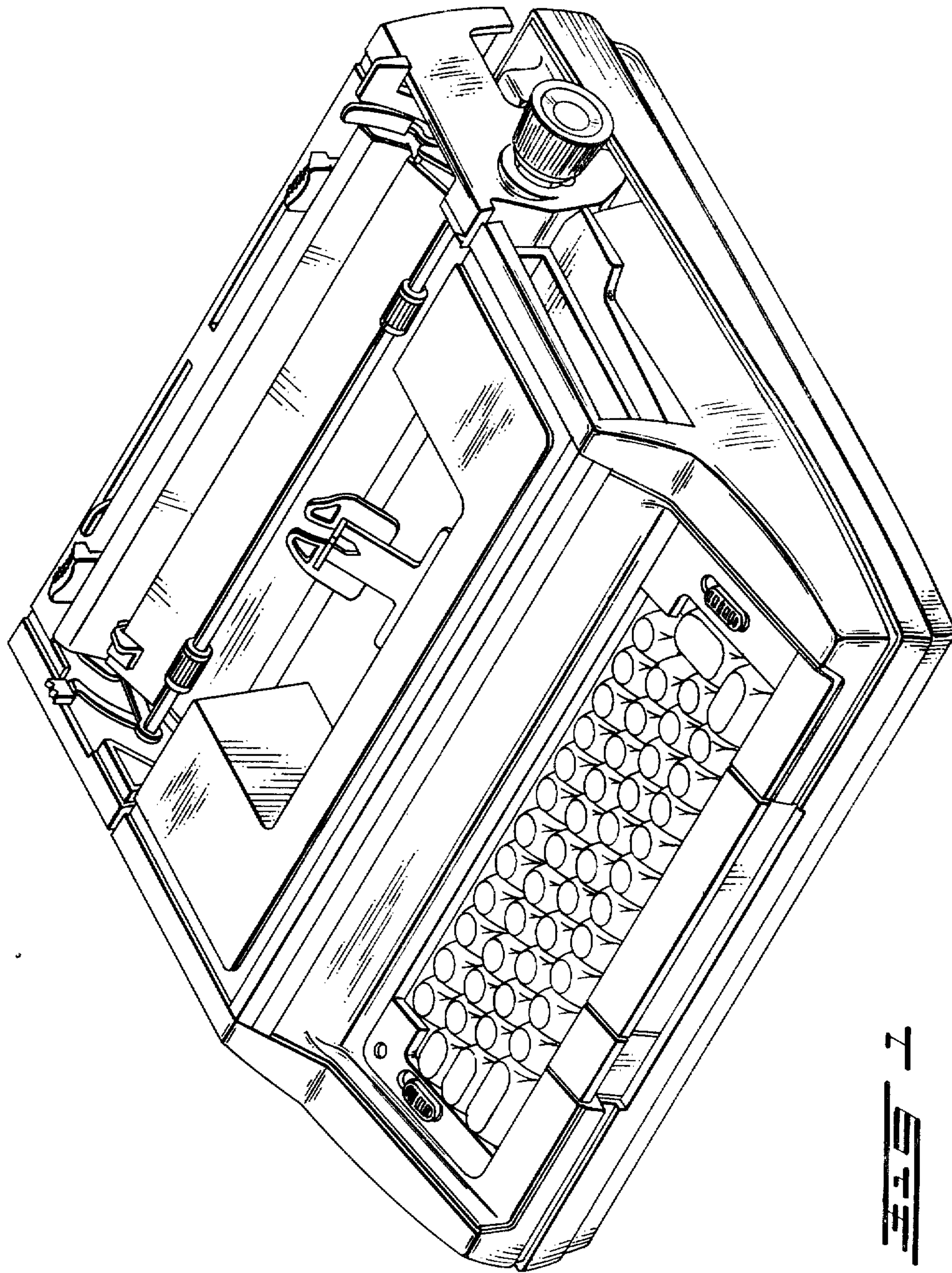

FIG. 1

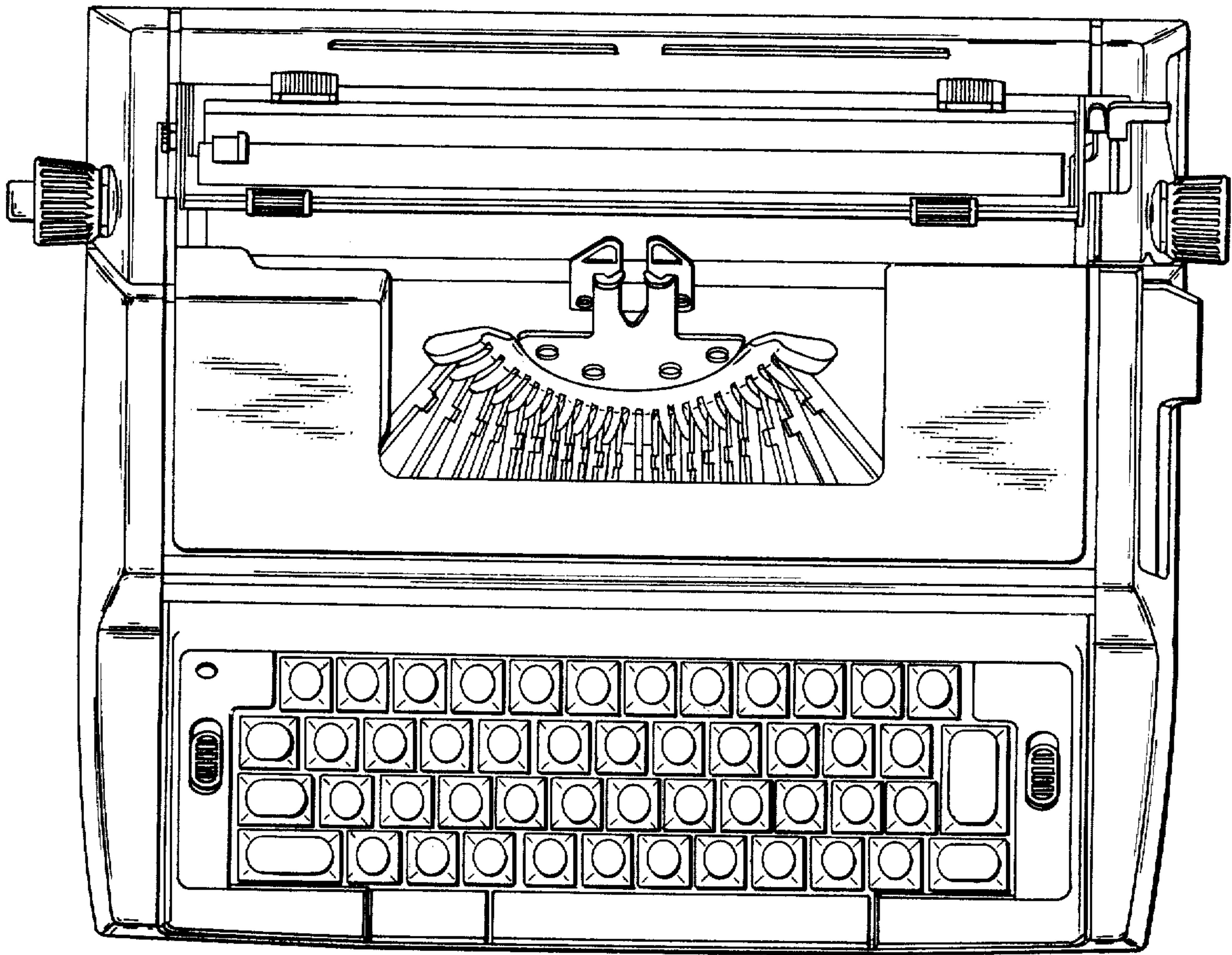

FIG 2

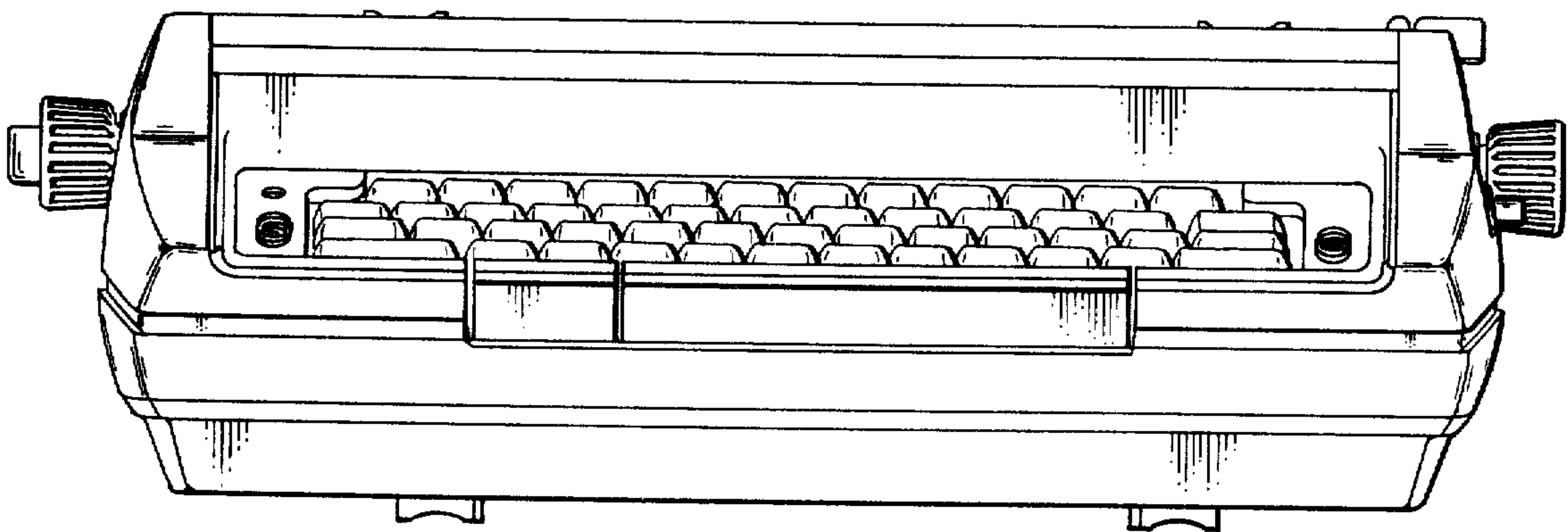

FIG 3

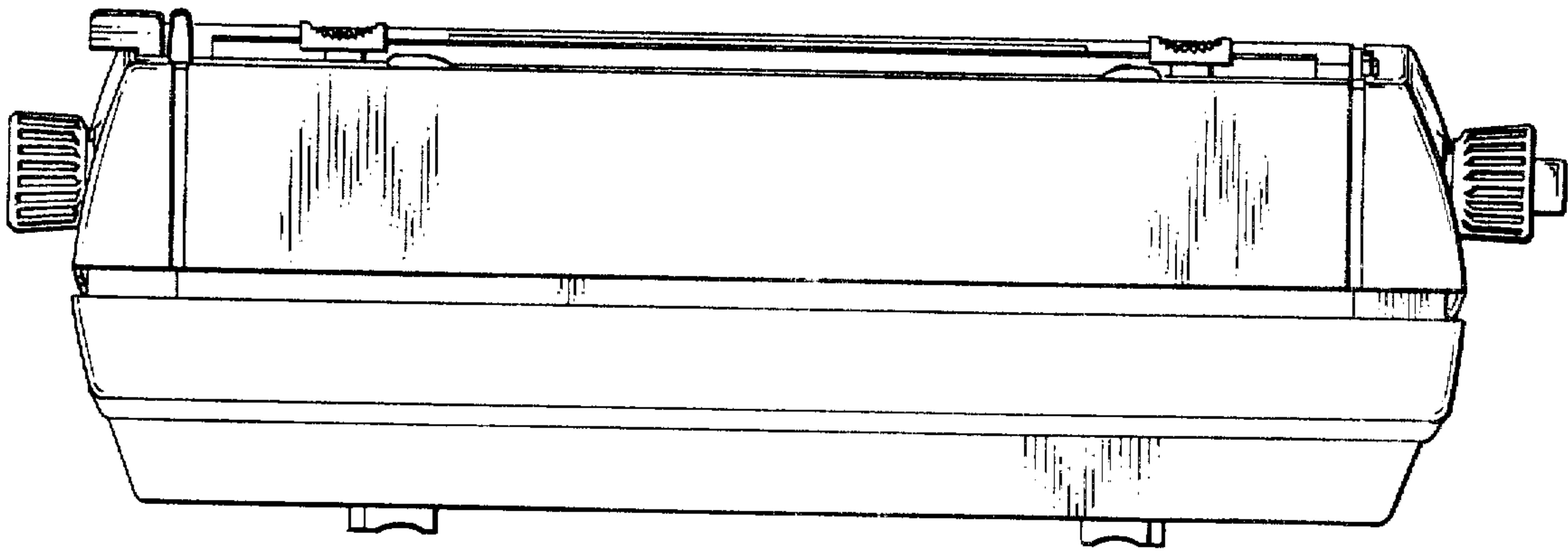

FIG. 4

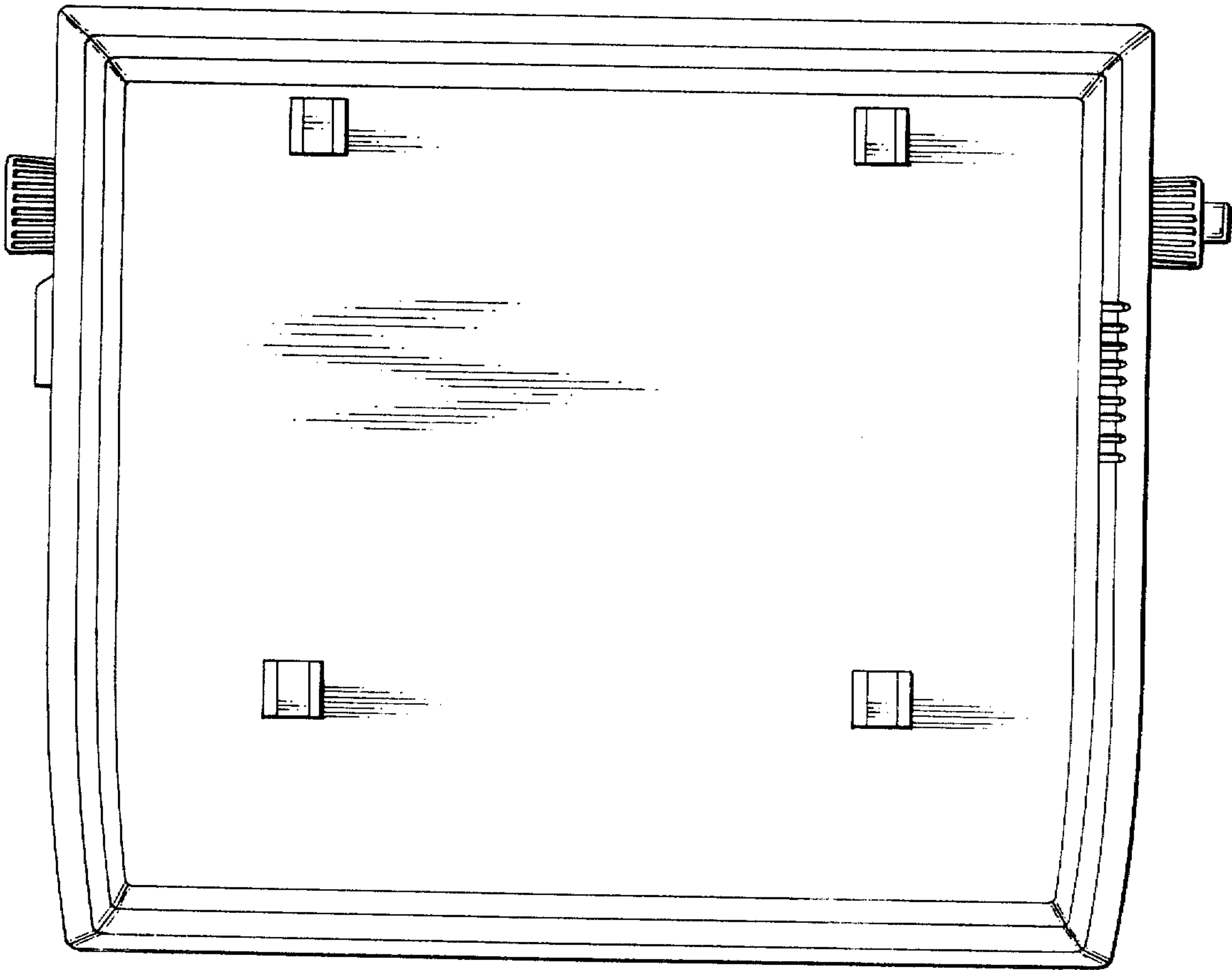

FIG. 5

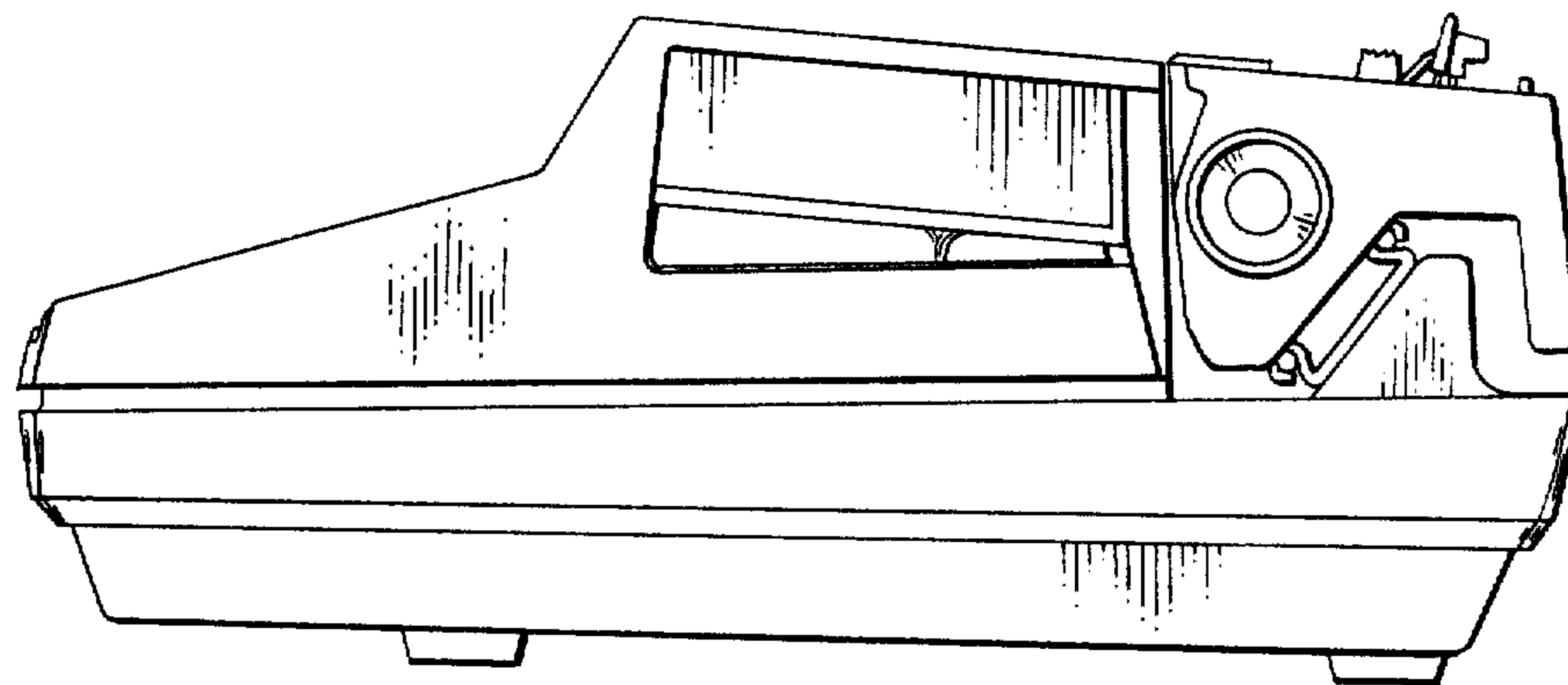

FIG 1

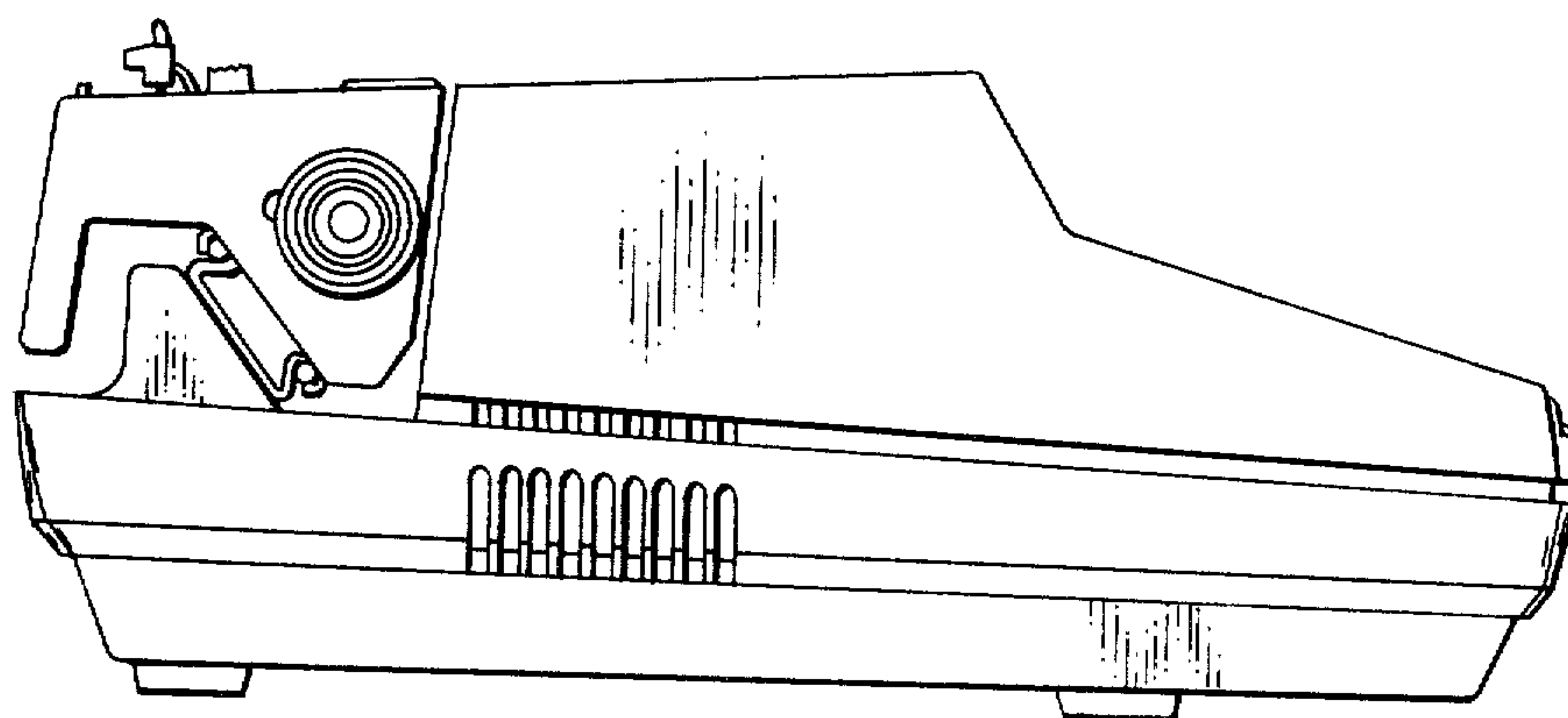

FIG 2