

[54] BABY CHAIR

[75] Inventors: Shinroku Nakao, Yokohama; Yoshiyasu Ishii; Masako Mizukami, both of Tokyo, all of Japan

[73] Assignee: Combi Co., Ltd., Tokyo, Japan

[**] Term: 14 Years

[21] Appl. No.: 49,856

[22] Filed: Jun. 18, 1979

[30] Foreign Application Priority Data

Dec. 26, 1978 [JP] Japan 53/55172

[51] Int. Cl. D6—01

[52] U.S. Cl. D6/7; D6/8; D6/10

[58] Field of Search D6/5, 7, 8; 297/317, 297/355, 377, 327, 328, 344, 457

[56] References Cited

U.S. PATENT DOCUMENTS

D. 234,379	2/1975	Catelli	D6/7
D. 246,682	12/1977	Nakao	D6/7
D. 252,118	6/1979	Meeker	D6/7
D. 253,204	10/1979	Rymes	D6/7
3,252,734	5/1966	Berbin	297/317
3,856,350	12/1974	Duke et al.	297/355
3,858,936	1/1975	Gerker	297/377

Primary Examiner—Bruce W. Dunkins
Attorney, Agent, or Firm—Sughrue, Mion, Zinn, Macpeak and Seas

[57] CLAIM

The ornamental design for a baby chair, as shown and described.

DESCRIPTION

FIG. 1 is a top, front and right side perspective view of a baby chair showing our new design; FIG. 2 is a right side elevational view thereof; FIG. 3 is a left side elevational view thereof; FIG. 4 is a front perspective view thereof; FIG. 5 is a rear elevational view thereof; FIG. 6 is a top perspective view thereof; and FIG. 7 is a bottom plan view thereof.

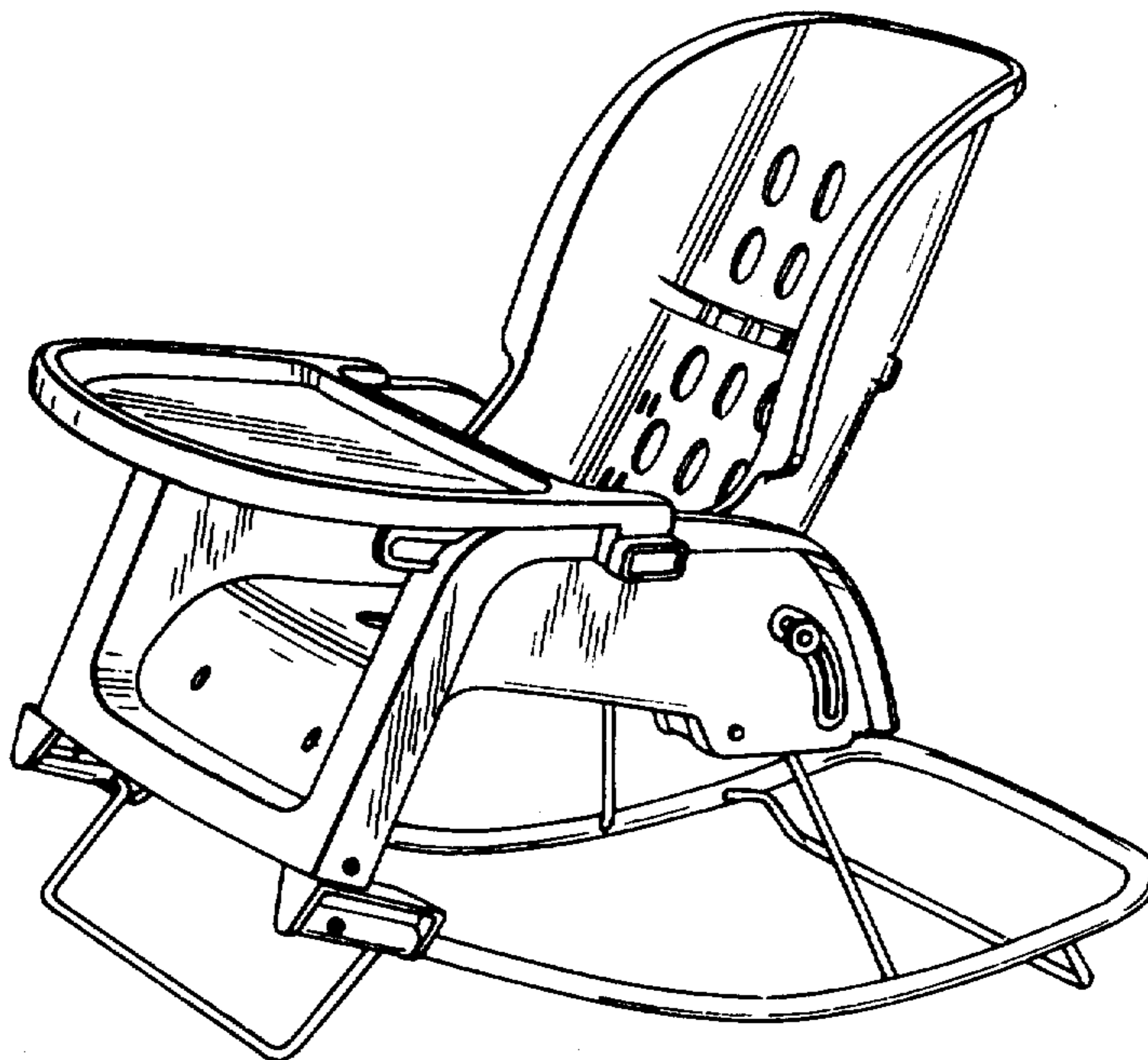

FIG. 1

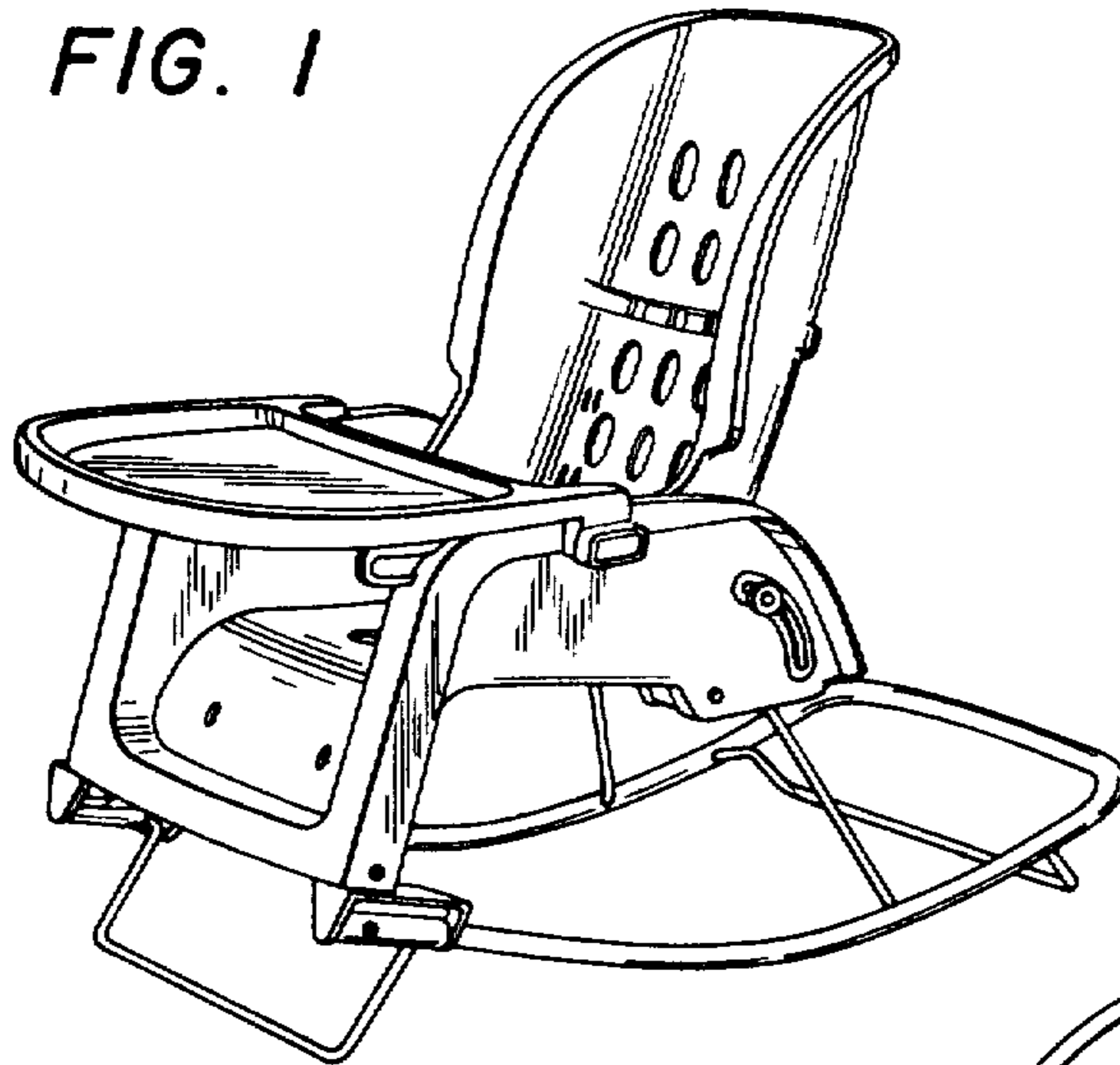

FIG. 2

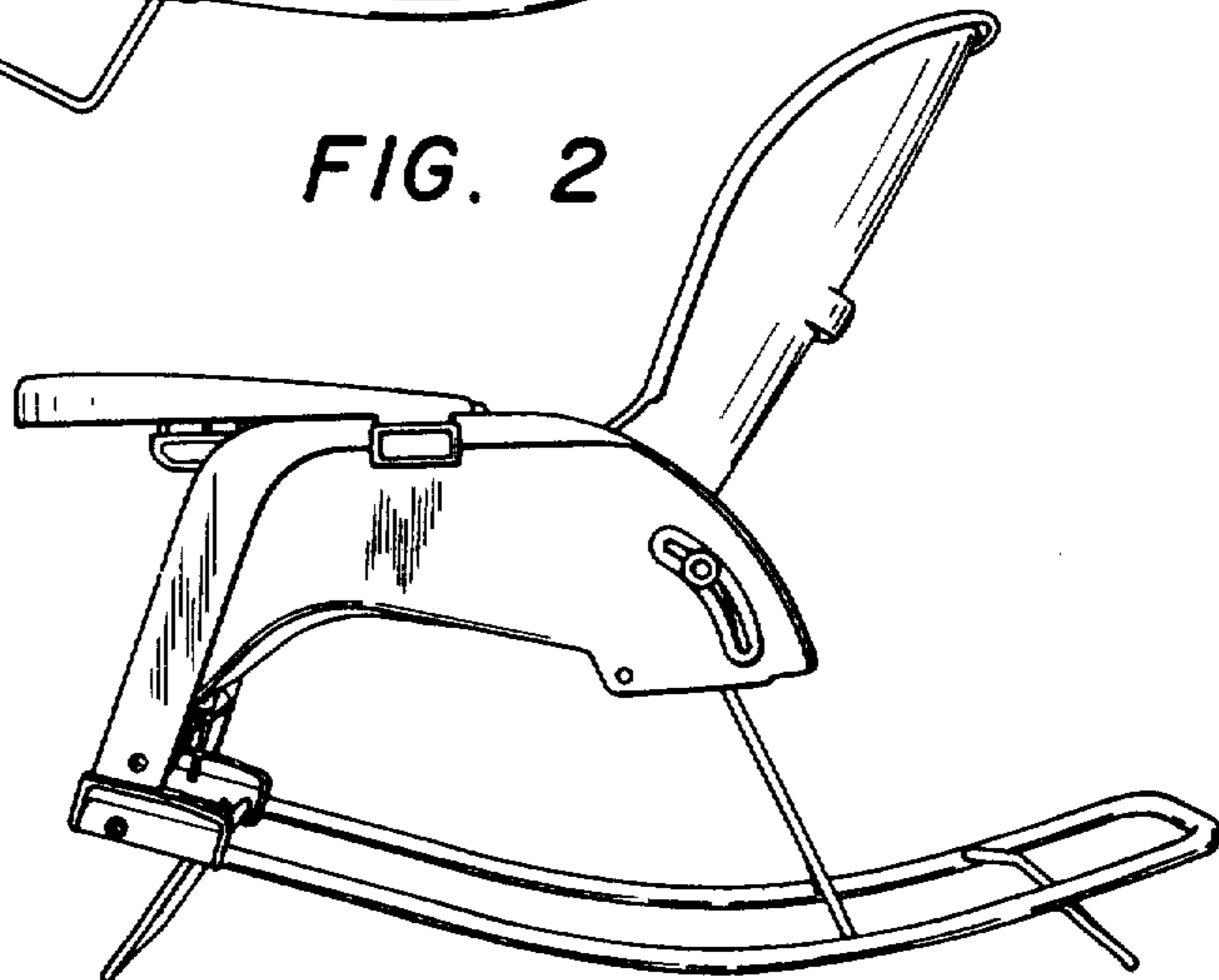

FIG. 3

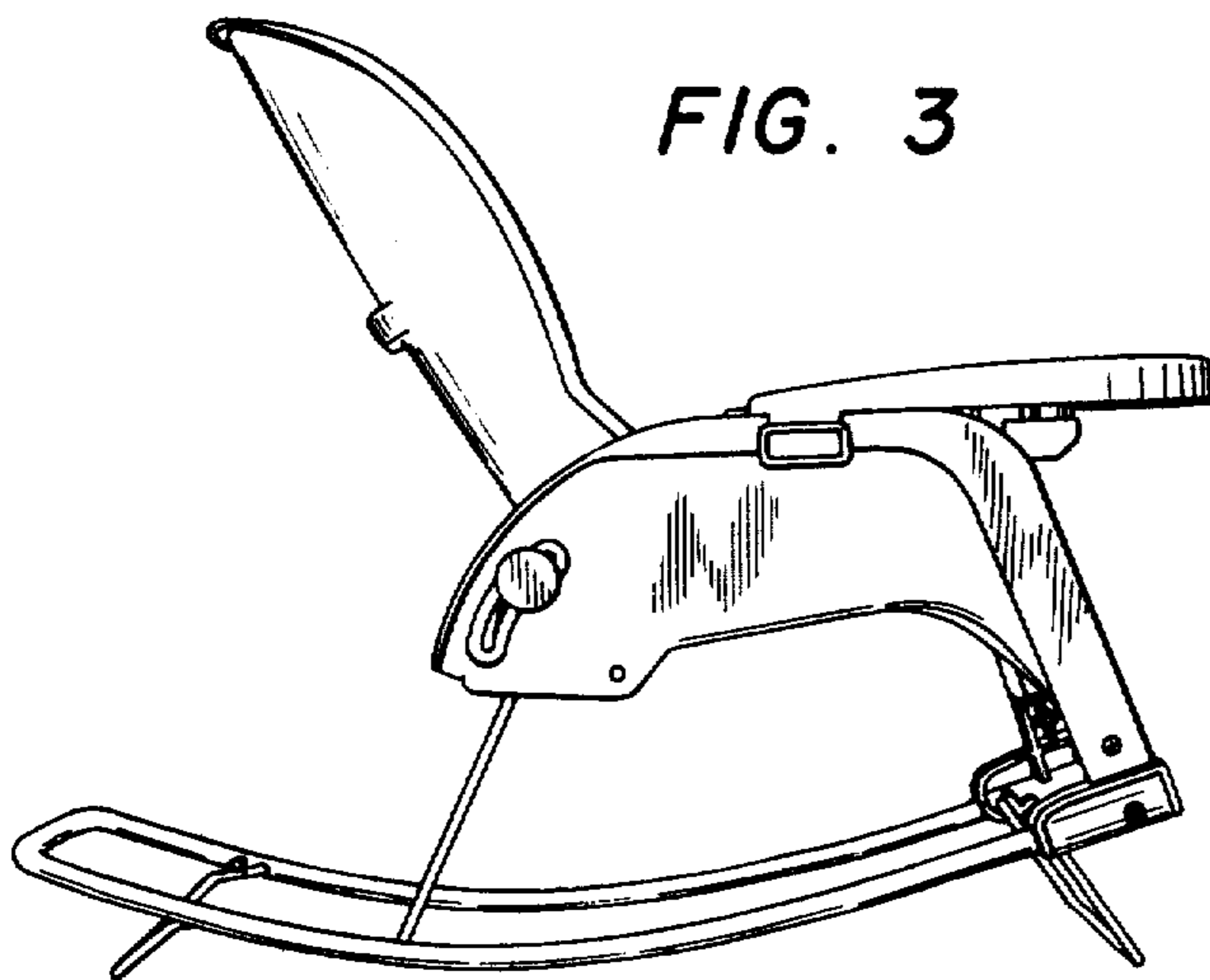

FIG. 4

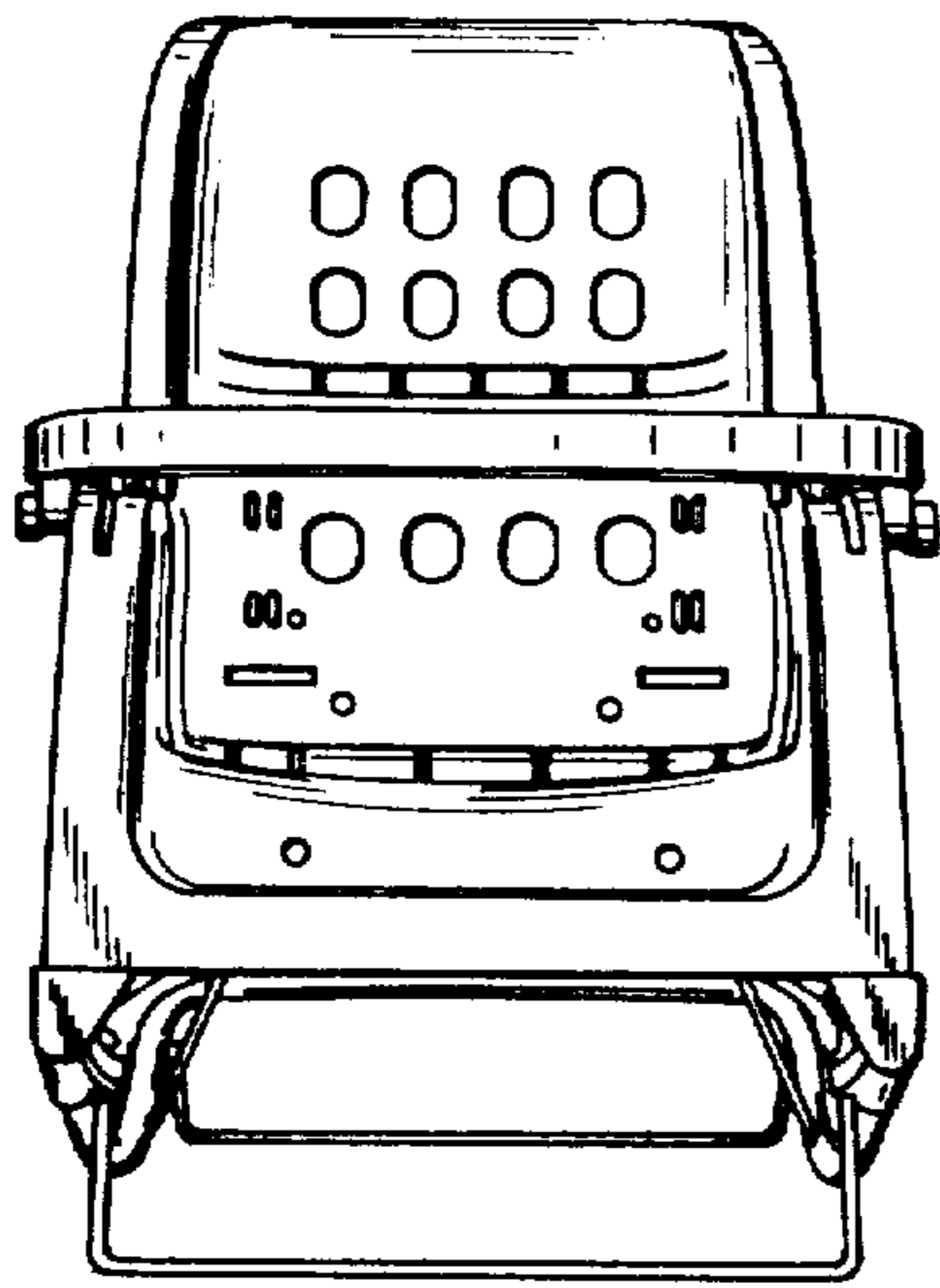

FIG. 5

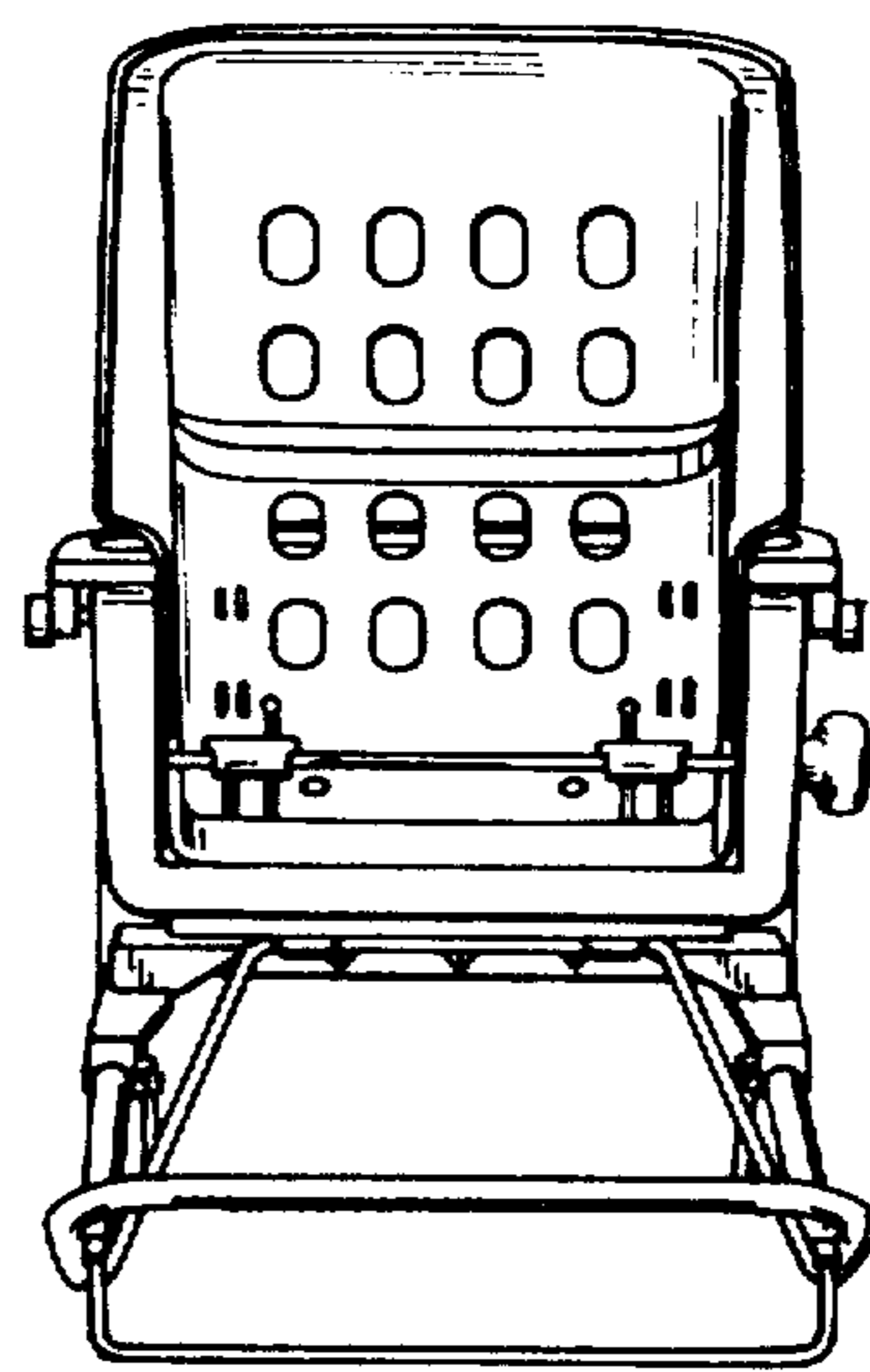

FIG. 6

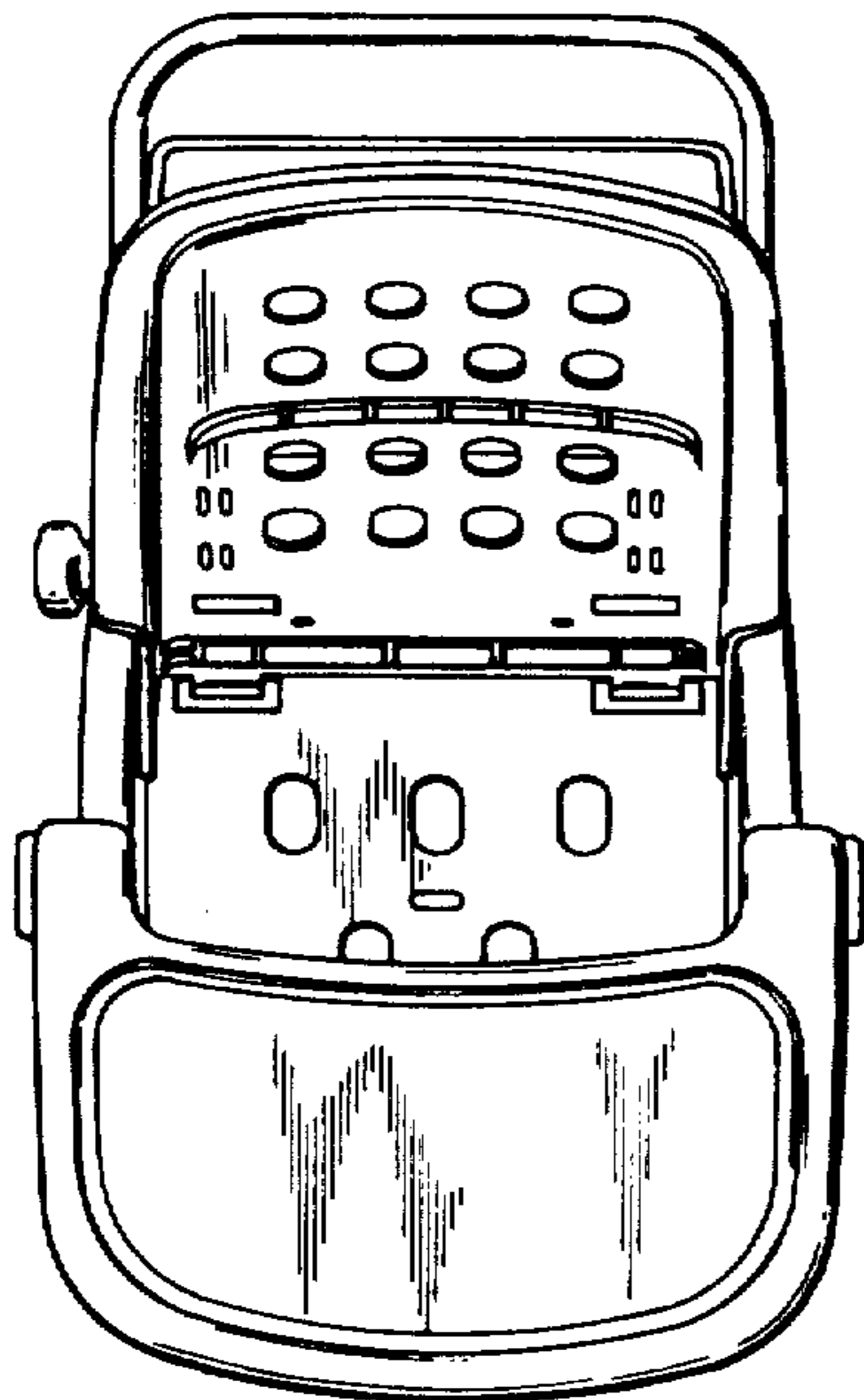

FIG. 7

