

[54] **SKATEBOARD**

[76] Inventor: **Leonard A. Morris, Sr.**, 138
Panorama Dr., Benicia, Calif. 94510

[**] Term: **14 Years**

[21] Appl. No.: **115,740**

[22] Filed: **Jan. 28, 1980**

[51] Int. Cl. **D21-02**

[52] U.S. Cl. **D21/227**

[58] Field of Search **D21/224-228;**
280/87.04 R, 87.04 A, 87.01, 11.19

[56] **References Cited**

U.S. PATENT DOCUMENTS

D. 222,158 10/1971 Noches **D21/228**

OTHER PUBLICATIONS

Playthings, 10-1977, p. 39, Skateboard at #500.
Skateboarder, 8-1978, p. 155, Item #10, Skateboard.

Printary Examiner—Charles A. Rademaker

[57] **CLAIM**

The ornamental design for a skateboard, as shown.

DESCRIPTION

The FIG. 1 is a perspective view of a skateboard, showing my new design;

The FIG. 2 is a top plan view thereof;

The FIG. 3 is a front elevational view thereof;

The FIG. 4 is a right elevational view thereof;

The FIG. 5 is a rear elevational view thereof; and

The FIG. 6 is a bottom plan view thereof.

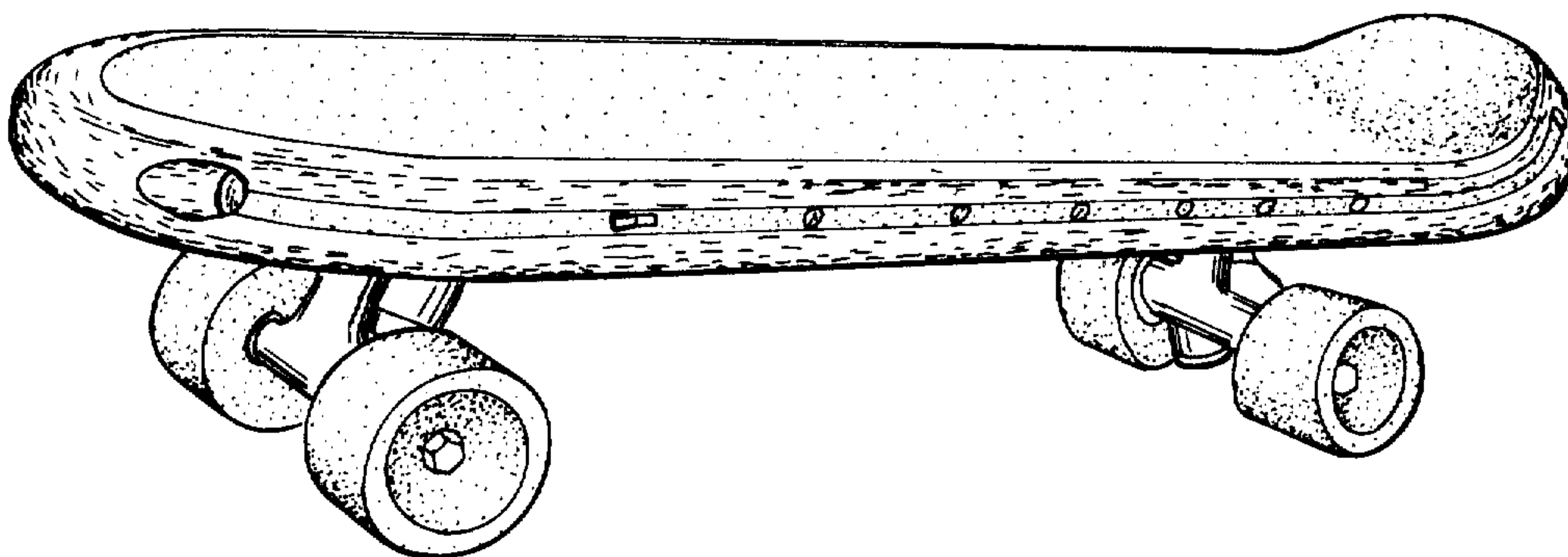

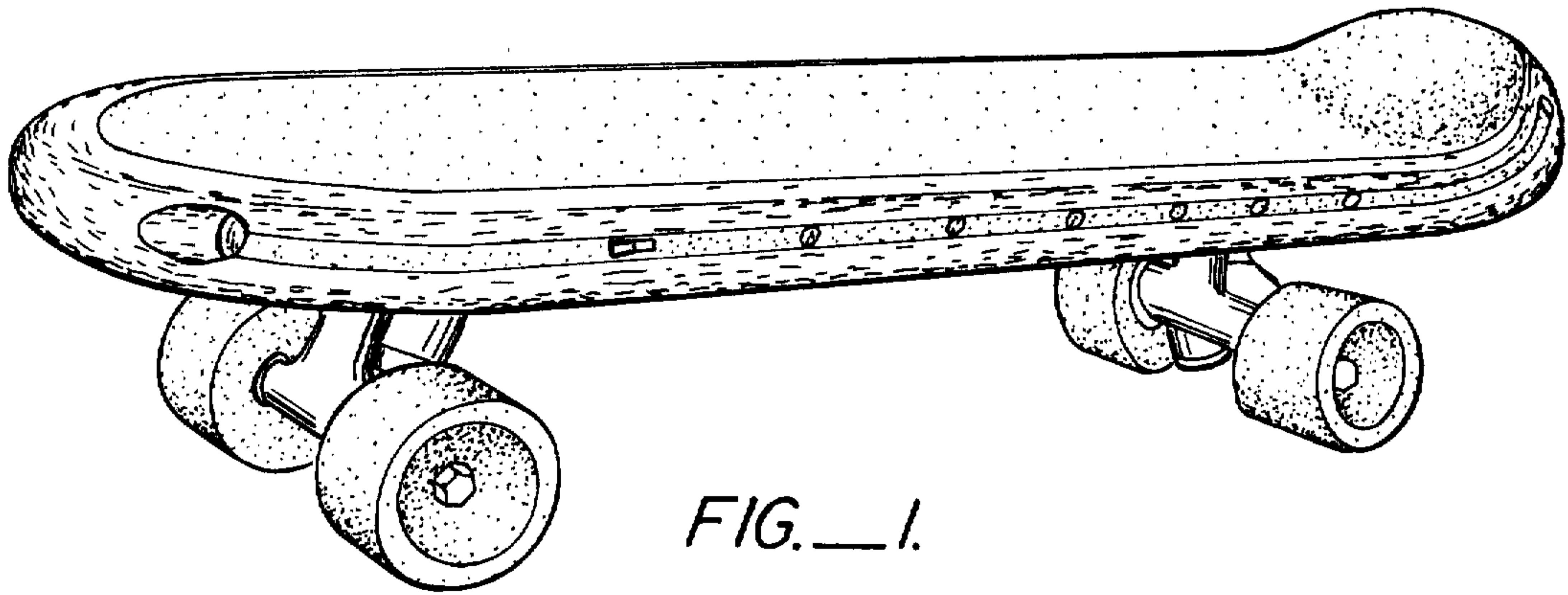

FIG. 1.

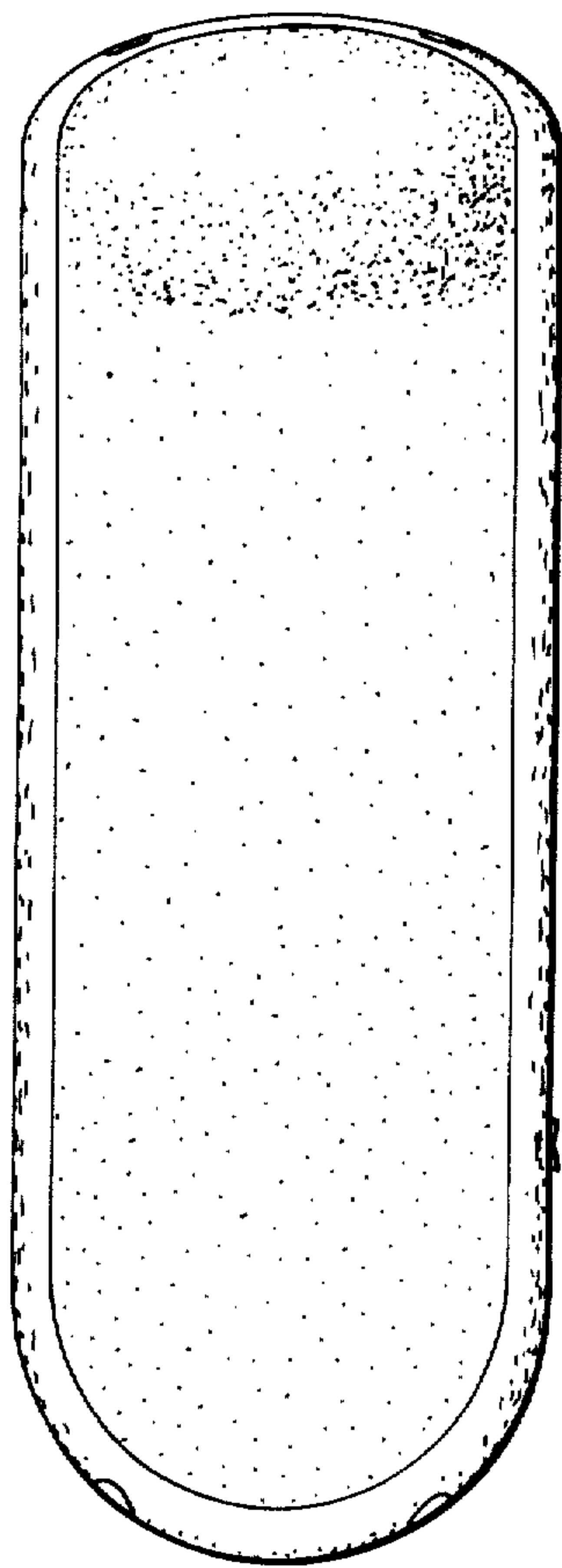

FIG. 2.

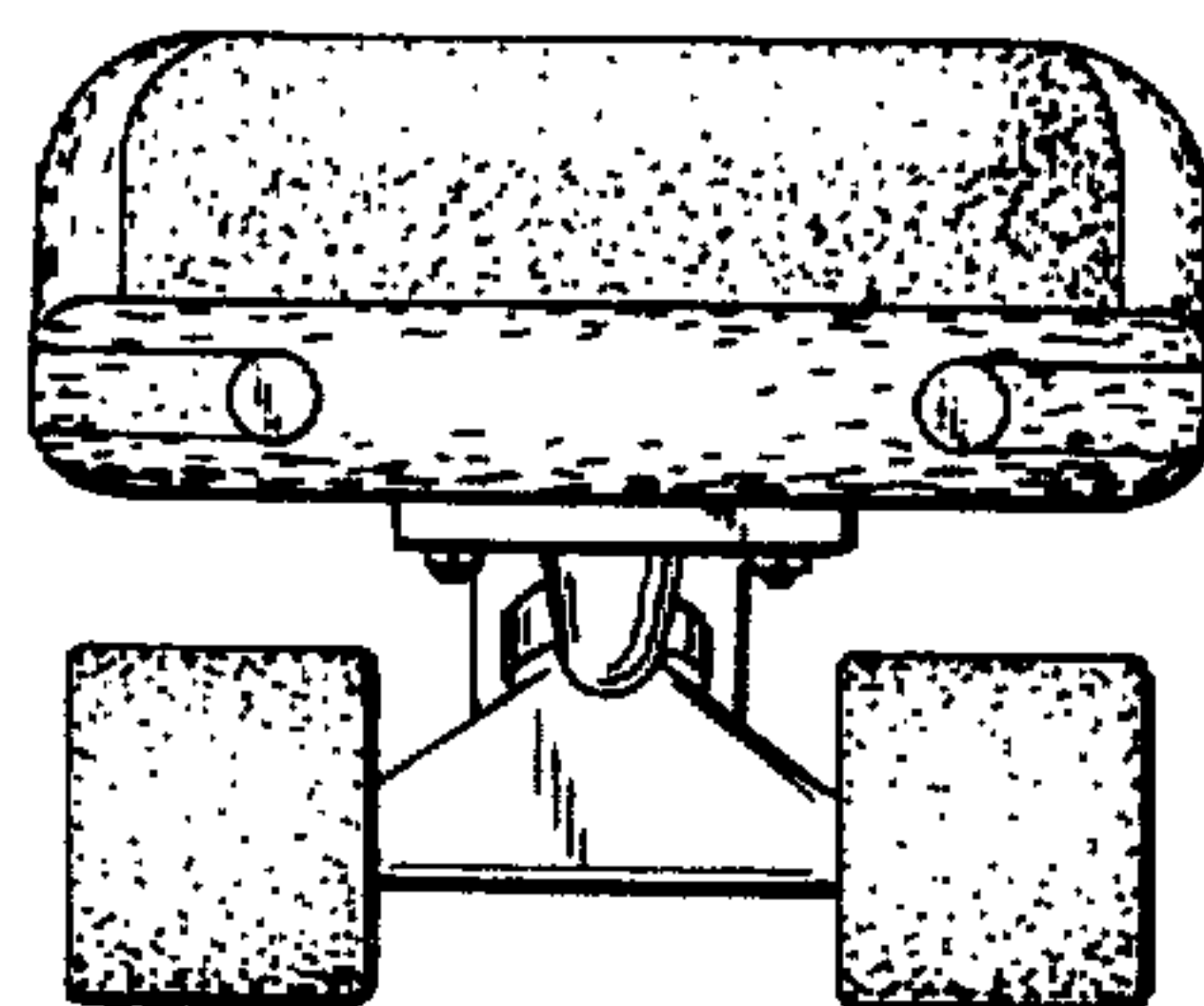

FIG. 3.

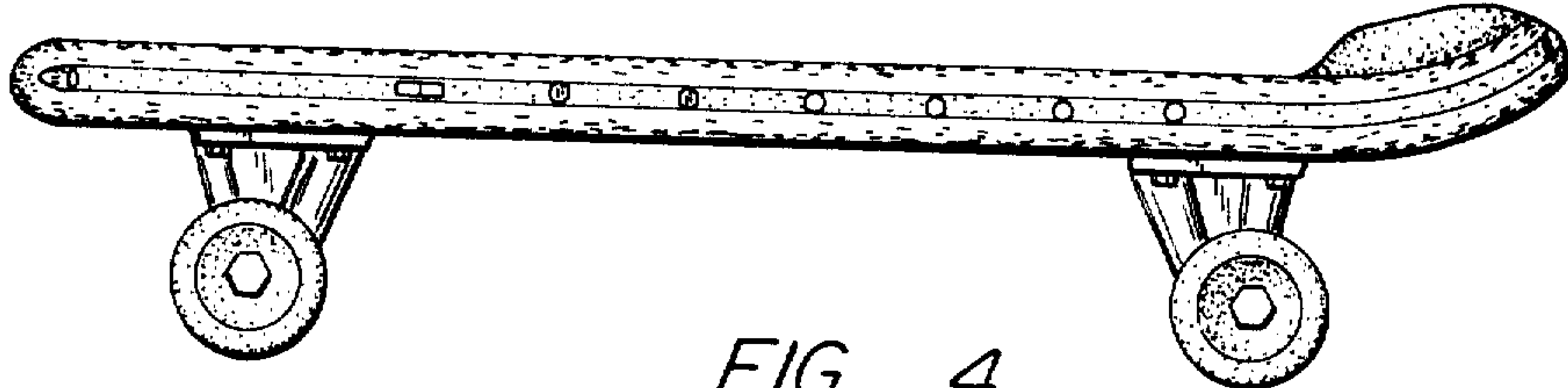

FIG. 4.

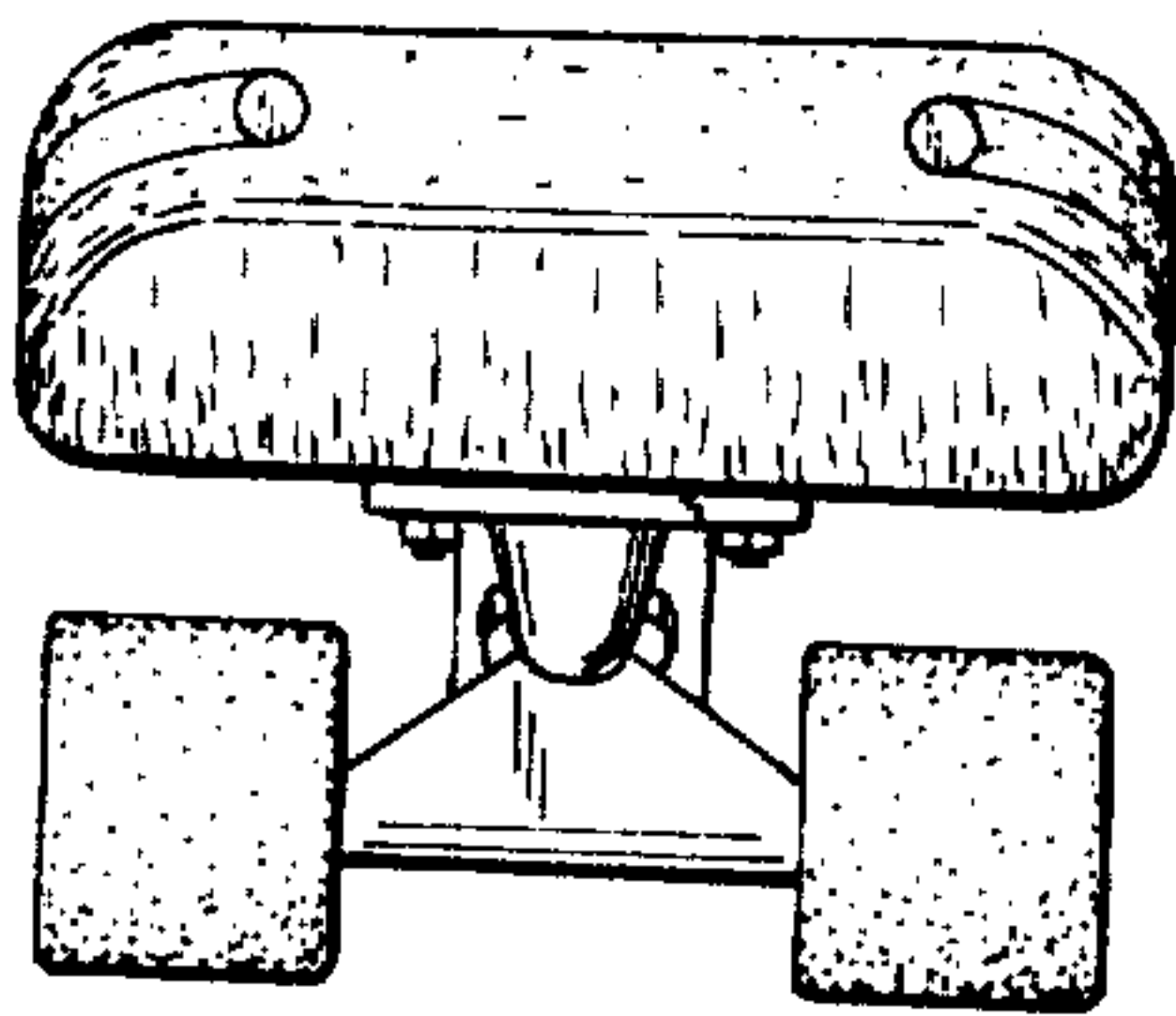

FIG. 5.

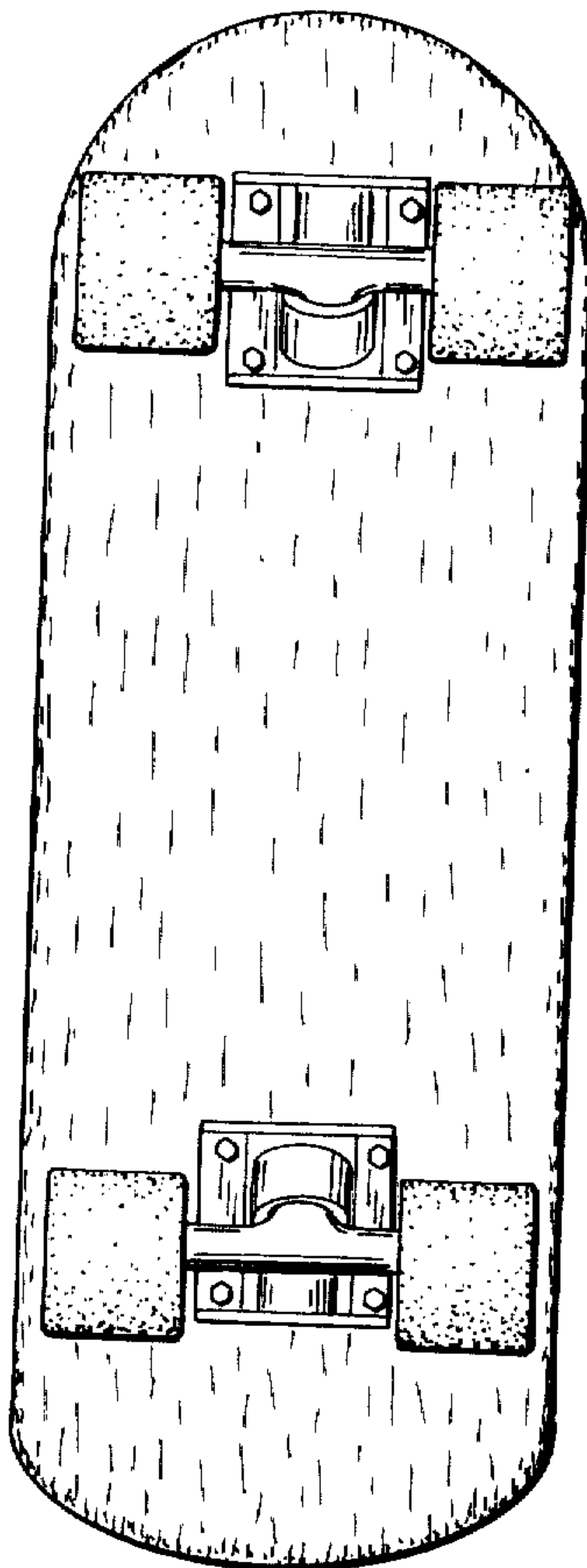

FIG. 6.