

[54] CAMERA

[75] Inventor: Udo M. Geissler, Munich, Fed. Rep. of Germany

[73] Assignee: Plaubel, Feinmechanik & Optik GmbH, Frankfurt am Main-Bergen-Enkheim, Fed. Rep. of Germany

[**] Term: 14 Years

[21] Appl. No.: 913,497

[22] Filed: Jun. 7, 1978

[30] Foreign Application Priority Data

Dec. 7, 1977 [DE] Fed. Rep. of Germany 738671

[51] Int. Cl. D16-01

[52] U.S. Cl. D16/06

[58] Field of Search D16/1, 2, 5, 6, 7, 8, D16/9, 10; 354/152, 158, 187-194, 202, 288

[56]

References Cited

U.S. PATENT DOCUMENTS

D. 100,563 7/1936 Hornung et al. D16/5
D. 198,727 7/1964 Conner et al. D16/5
3,295,426 1/1967 Land et al. D16/5 X
4,146,320 3/1979 Schrader 354/187
4,175,847 11/1979 Schrader 354/187

Primary Examiner—Catherine E. Kemper

[57]

CLAIM

The ornamental design for a camera, as shown and described.

DESCRIPTION

FIG. 1 is a front elevational view of a camera, showing my new design shown with the lens retracted;
FIG. 2 is a top plan view thereof;
FIG. 3 is a bottom plan view thereof;
FIG. 4 is a rear elevational view thereof;
FIG. 5 is a left side elevational view thereof;
FIG. 6 is a right side elevational view thereof;
FIG. 7 is a front elevational view of the camera shown with lens extended;
FIG. 8 is a top plan view thereof;
FIG. 9 is a bottom plan view thereof;
FIG. 10 is a left side elevational view thereof; and
FIG. 11 is a right side elevational view thereof.

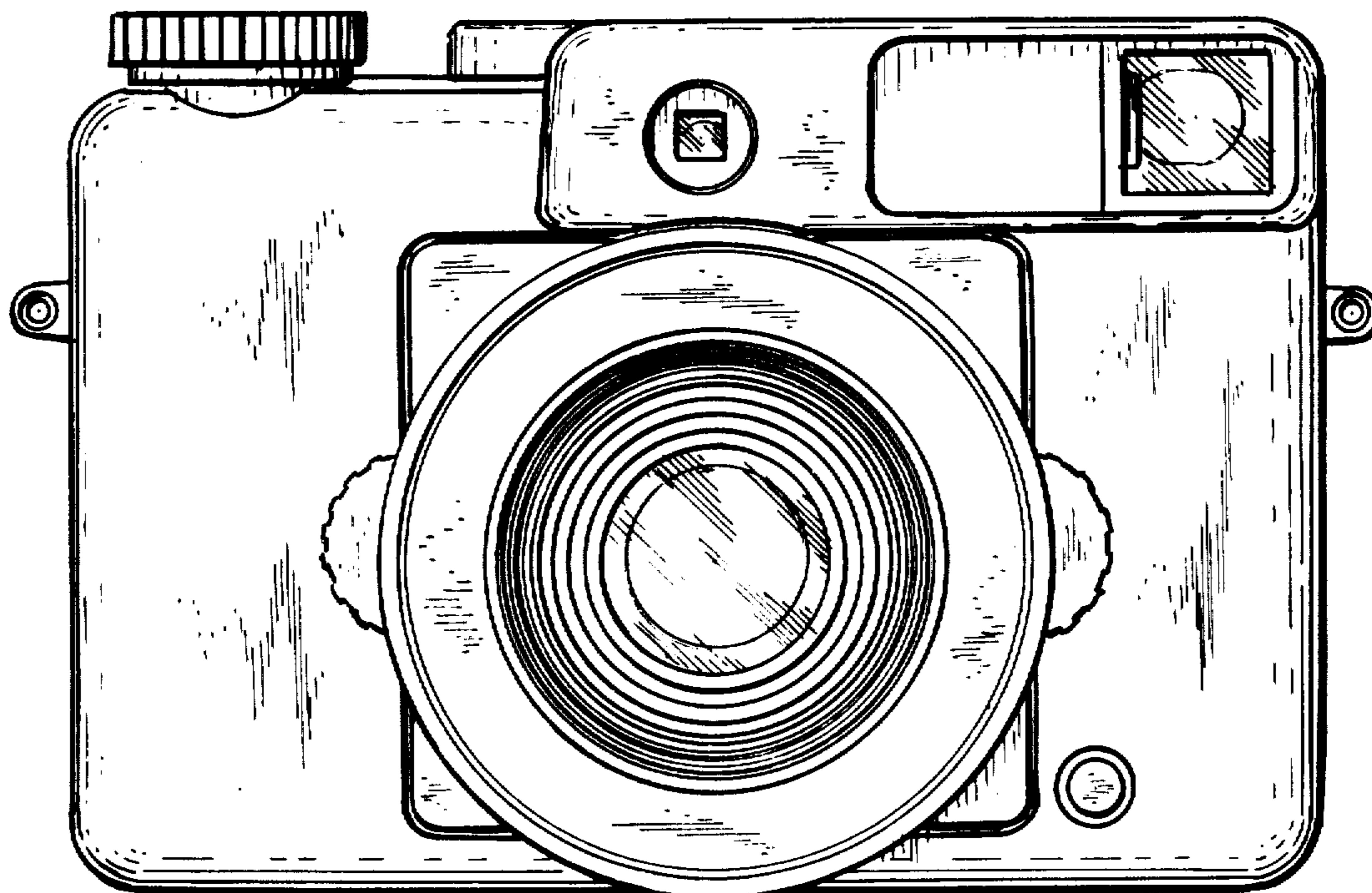

FIG. 1.

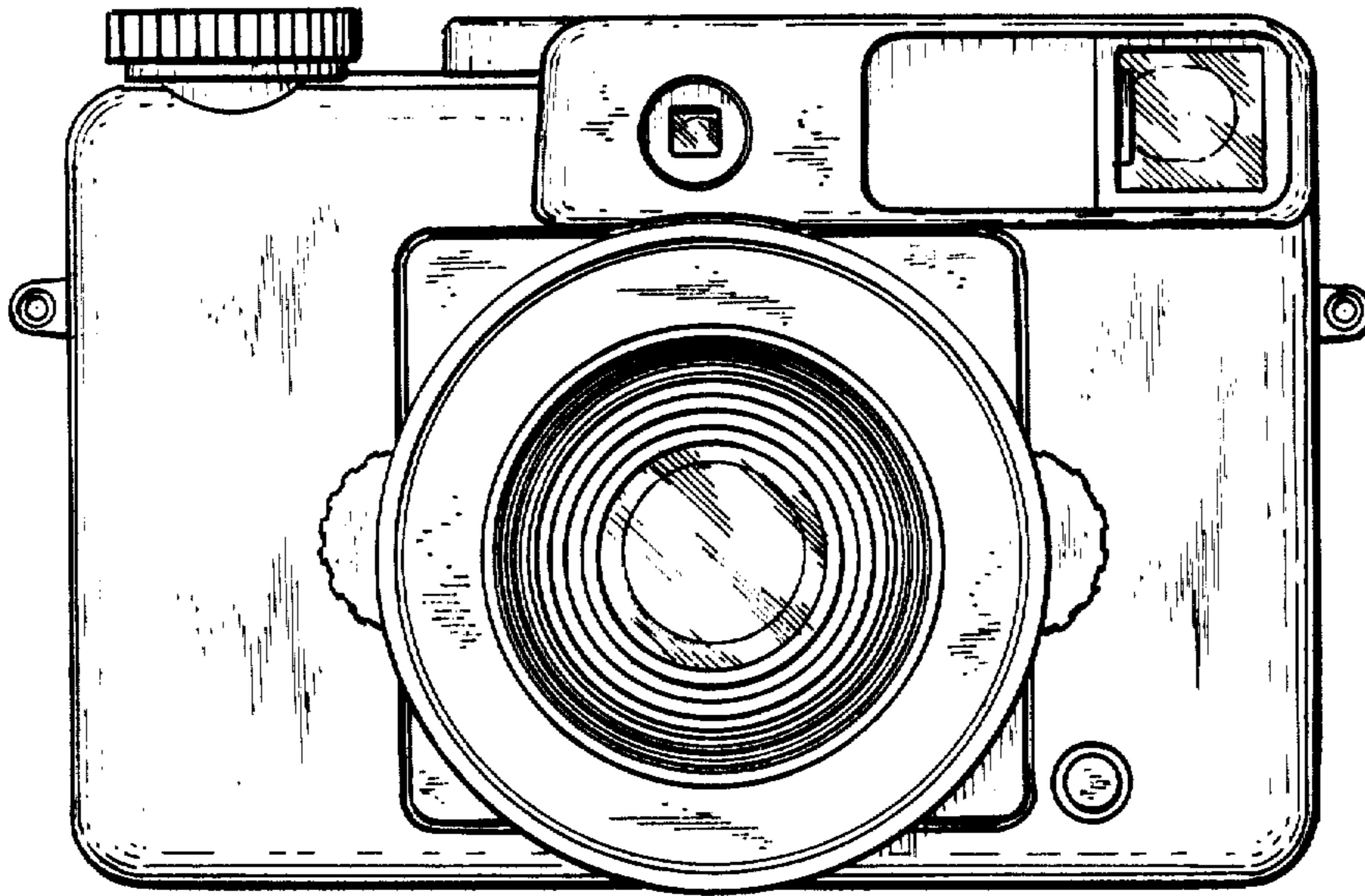

FIG. 2.

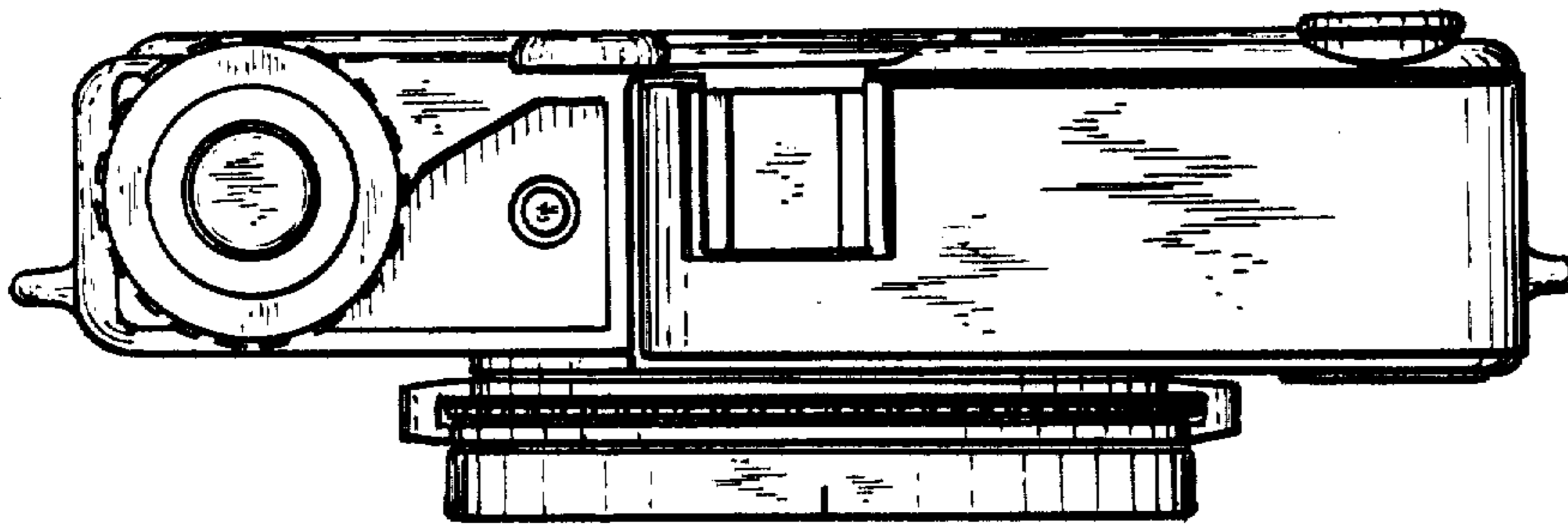

FIG. 3.

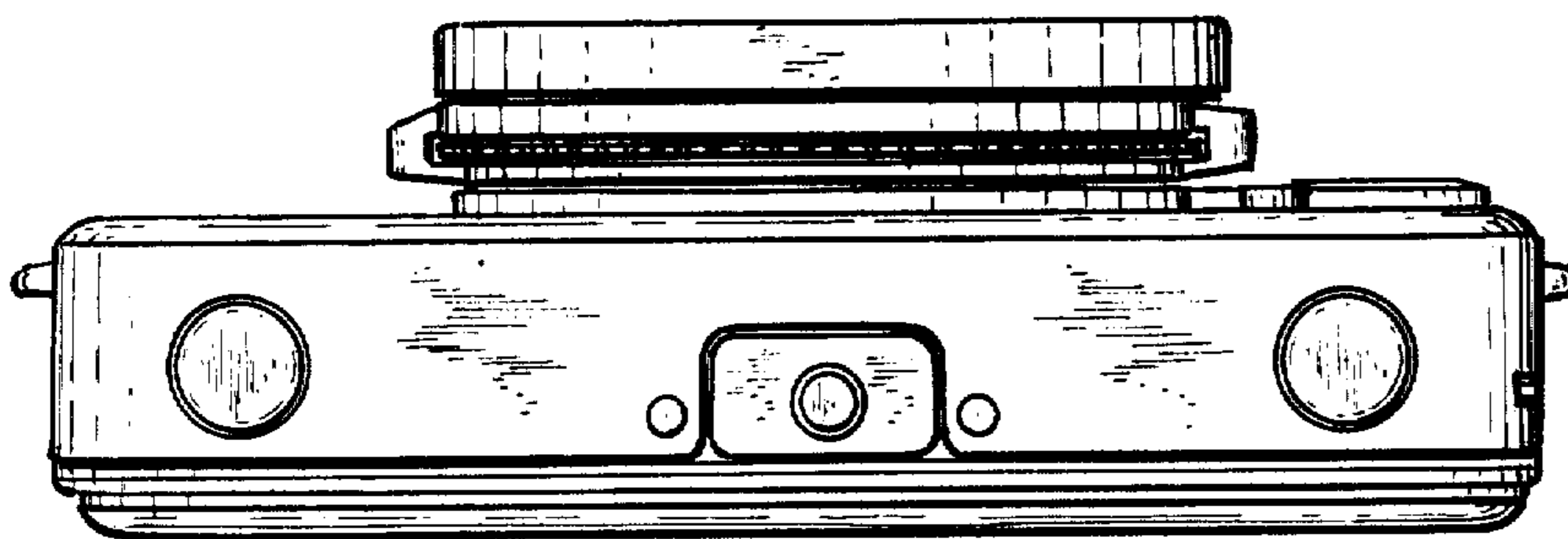

FIG. 5.

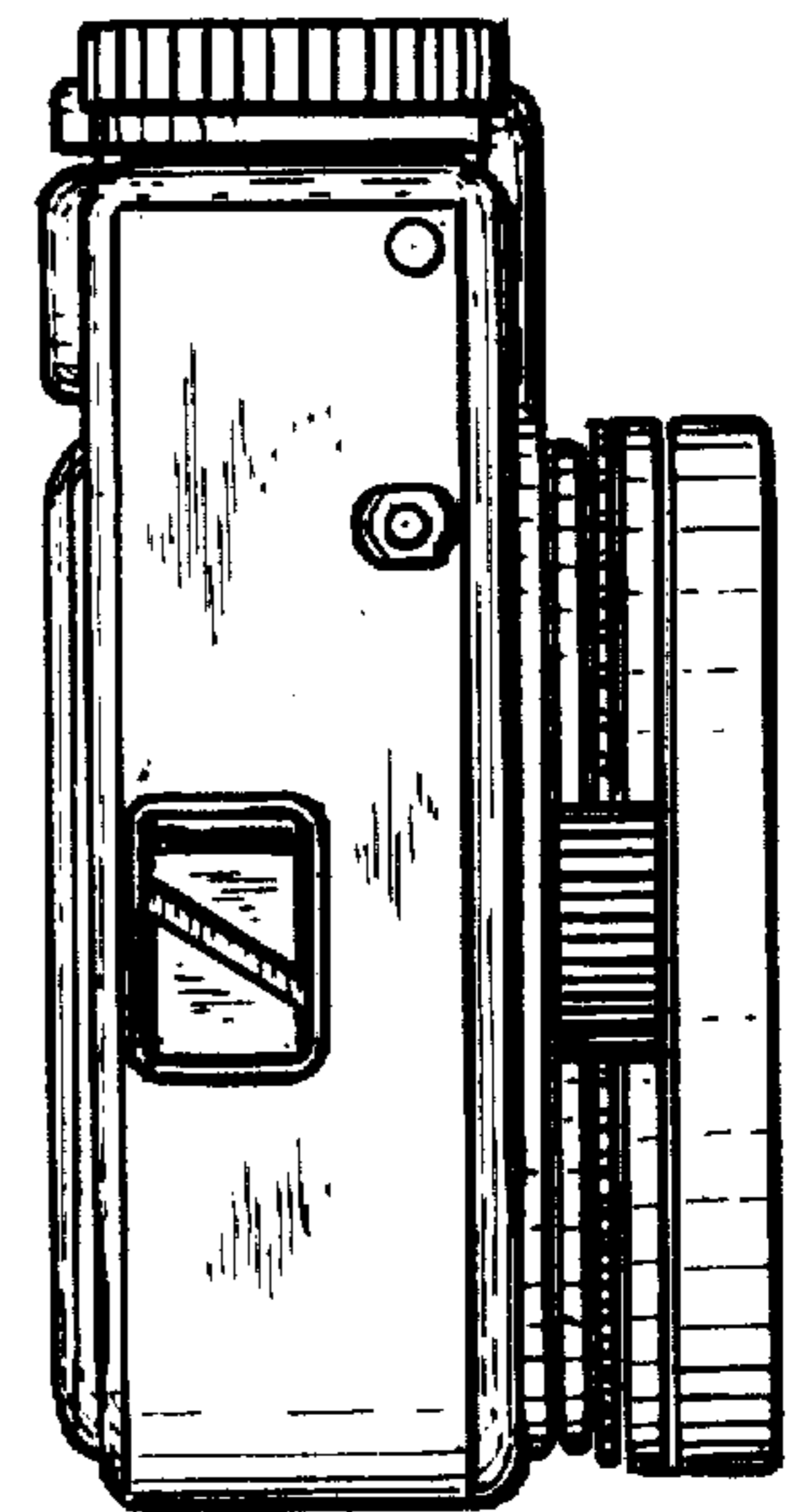

FIG. 4.

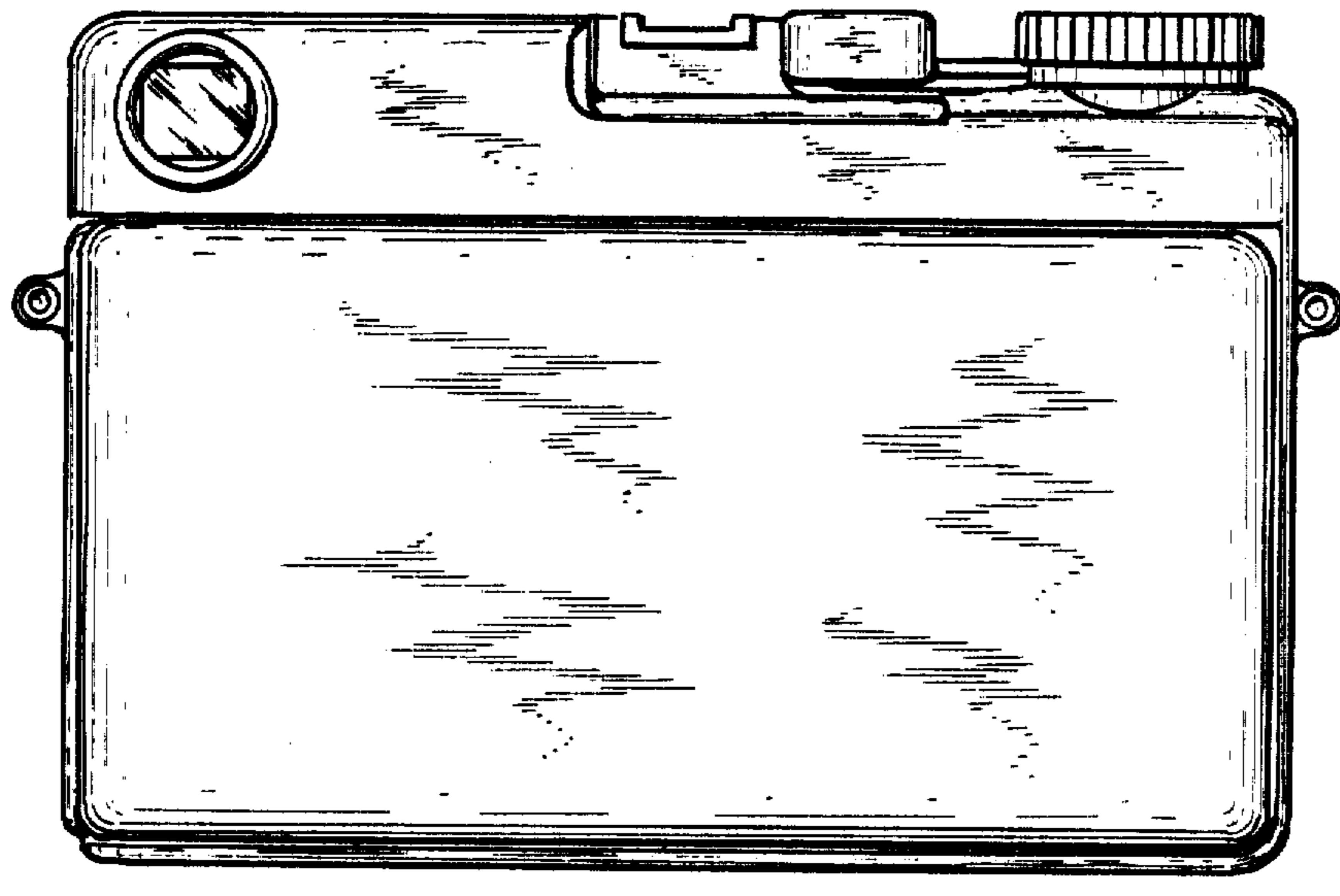

FIG. 6.

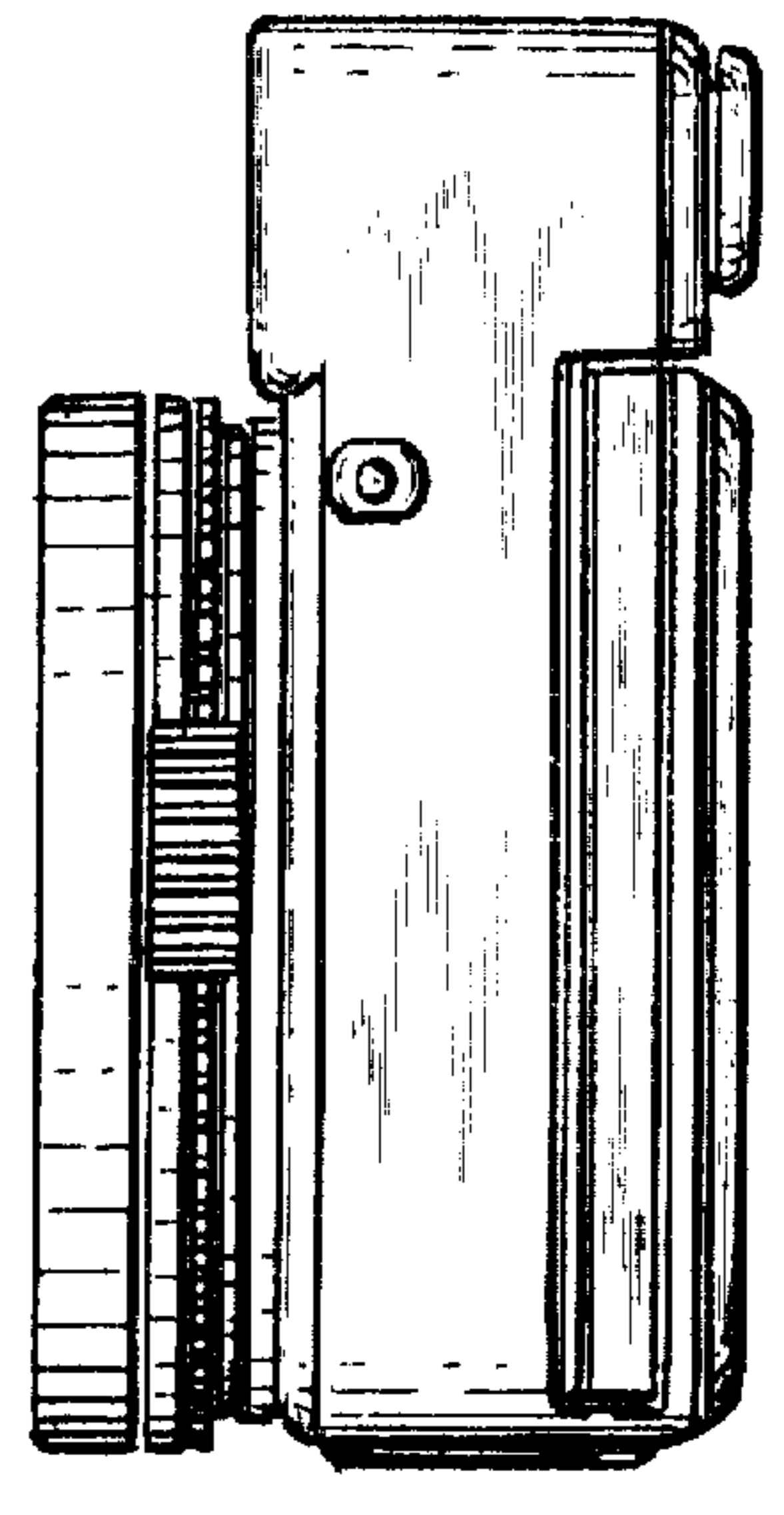

FIG. 7.

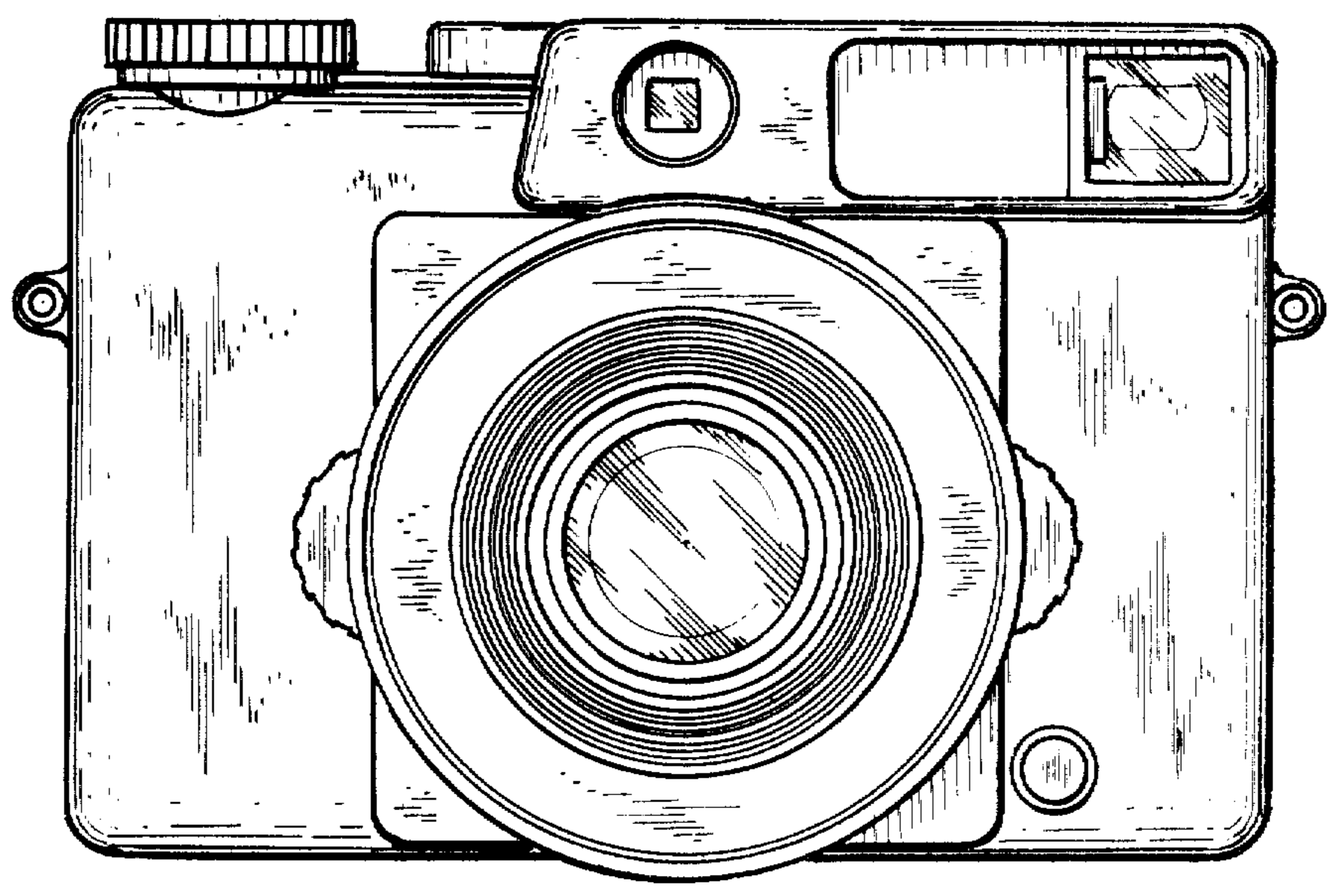

FIG. 8.

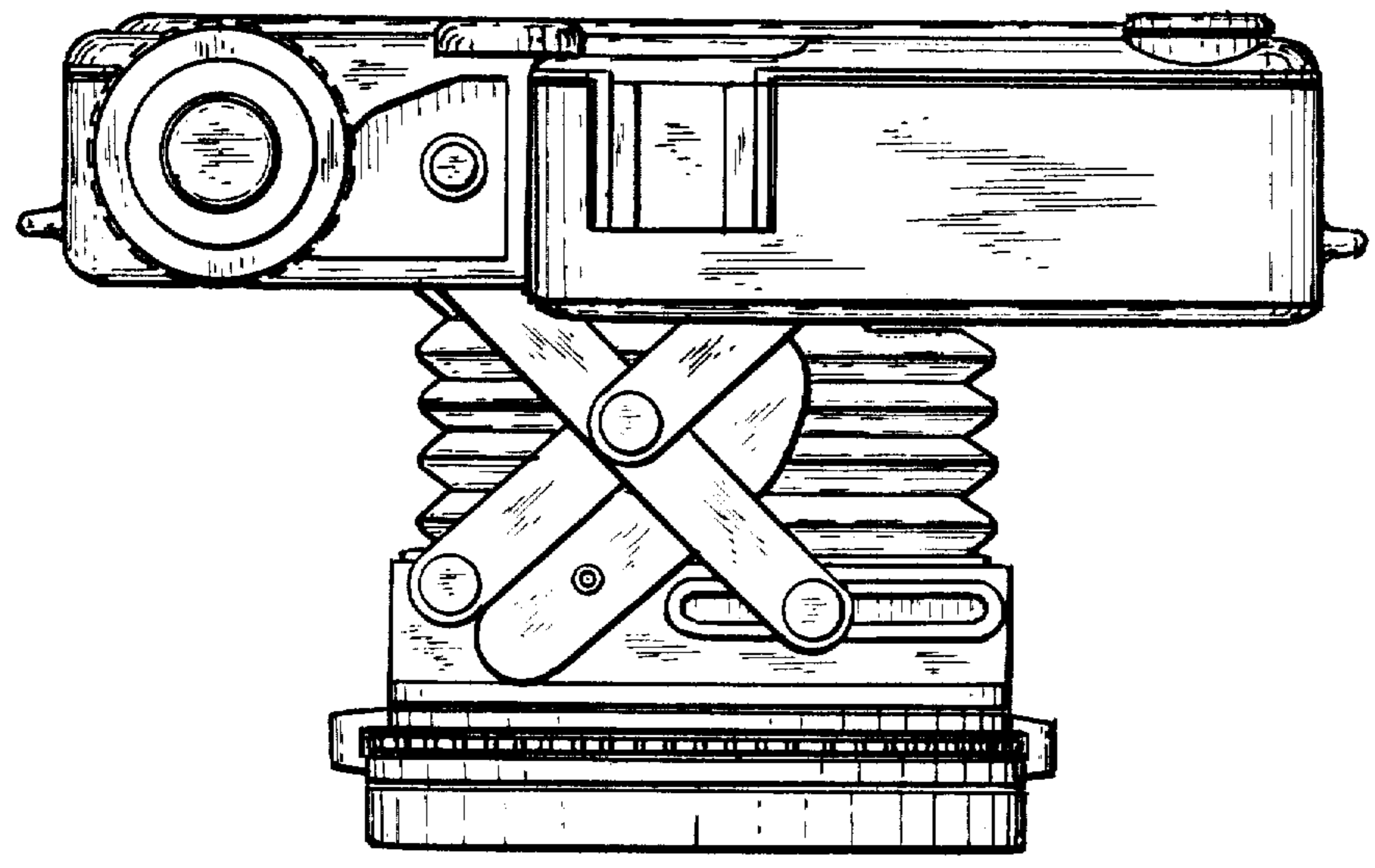

FIG. 9.

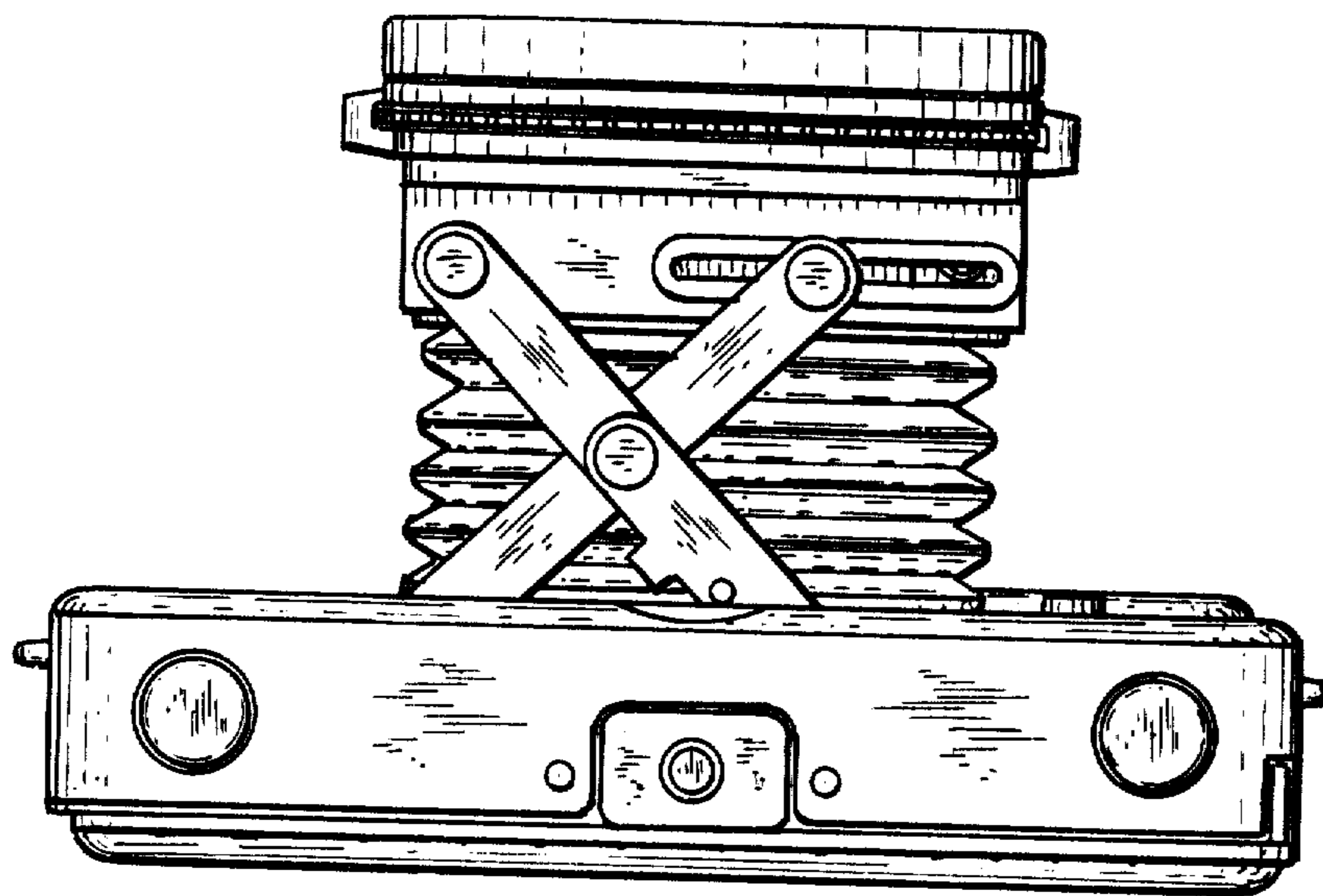

FIG. 10.

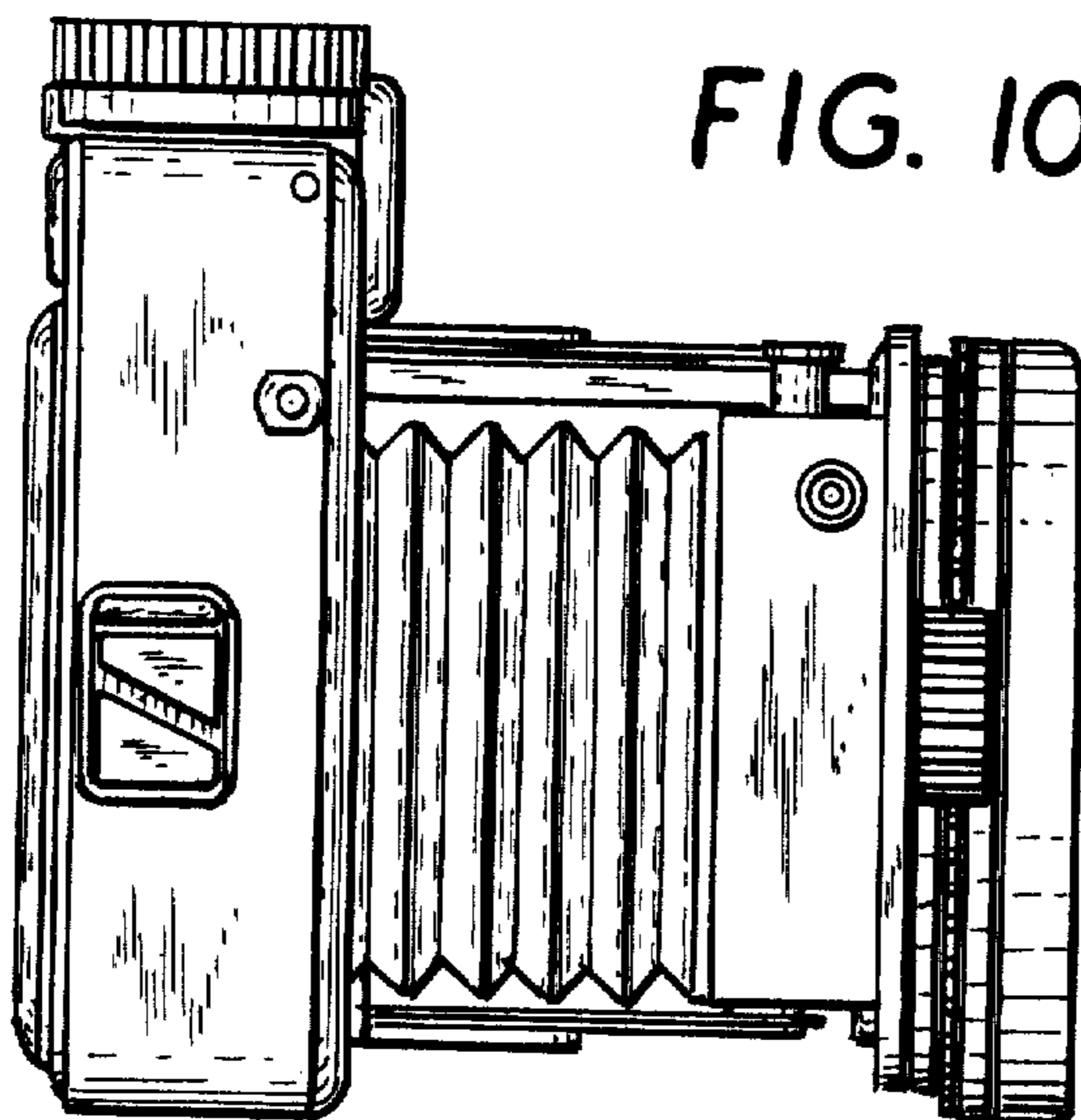

FIG. 11.

