

[54] EARRING

[75] Inventor: Elias Epstein, Flushing, N.Y.

[73] Assignee: Kaspar & Esh, Inc., New York, N.Y.

[**] Term: 14 Years

[21] Appl. No.: 109,526

[22] Filed: Jan. 4, 1980

[51] Int. Cl. D11-01

[52] U.S. Cl. D11/75

[58] Field of Search D11/7, 40, 43, 47, 75, D11/79; 63/1 R-2, 12-14 R, 18-21, 23

[56] References Cited

U.S. PATENT DOCUMENTS

130,771 8/1872 Tryner 63/13

D. 257,024 9/1980 Barr D11/43
4,218,894 8/1980 Tropea 63/13

Primary Examiner—Louis S. Zarfes
Attorney, Agent, or Firm—Burgess, Ryan and Wayne

[57] CLAIM

The ornamental design for an earring, substantially as shown and described.

DESCRIPTION

FIG. 1 is a front elevational view thereof of an earring showing my new design;
FIG. 2 is a rear elevational view thereof, the broken line showing of a nut being for illustrative purposes only;
FIG. 3 is a left side elevational view thereof; the right side being a mirror image;
FIG. 4 is a top plan view thereof; and
FIG. 5 is a bottom plan view thereof.

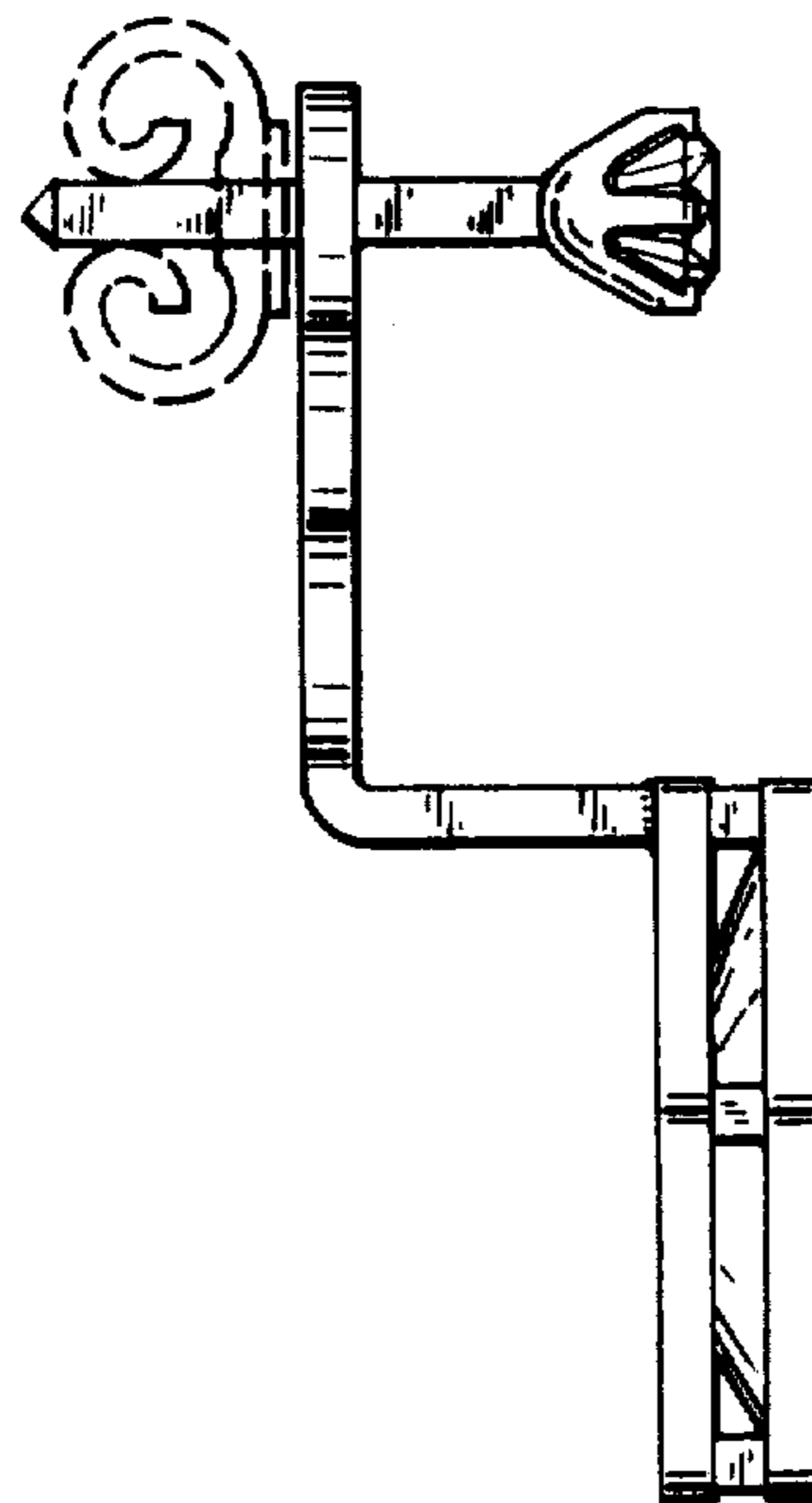
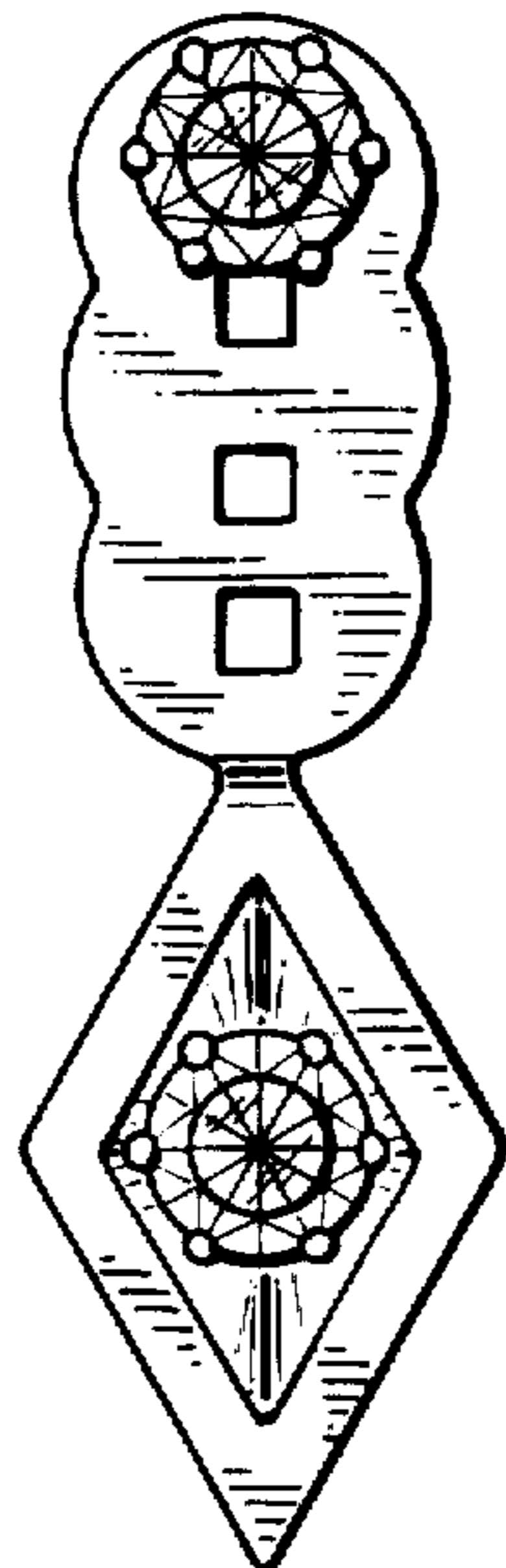

FIG.1

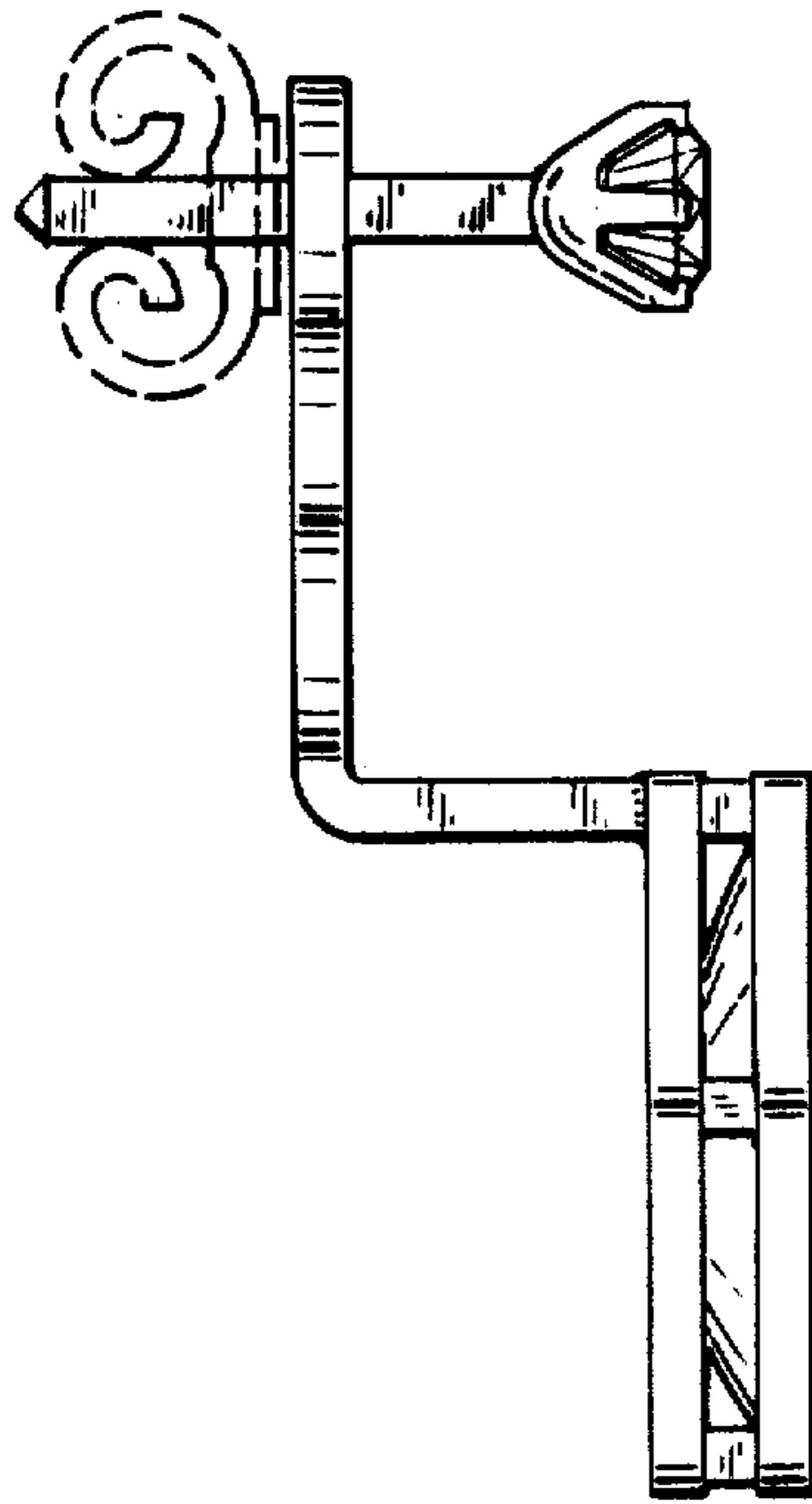
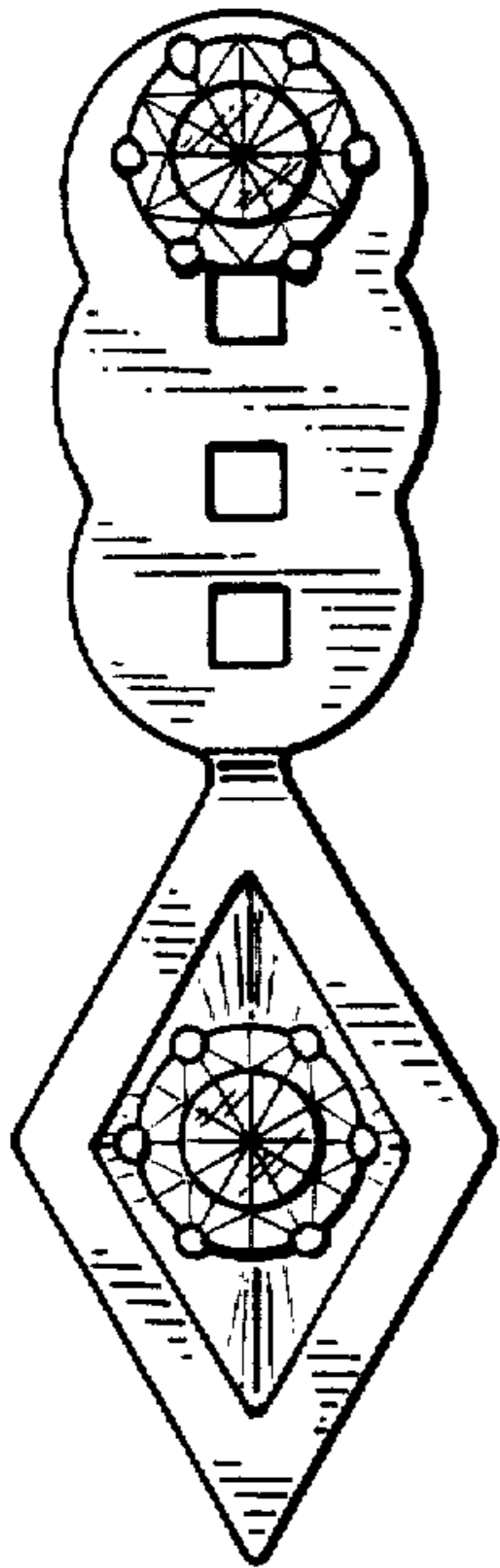

FIG.3

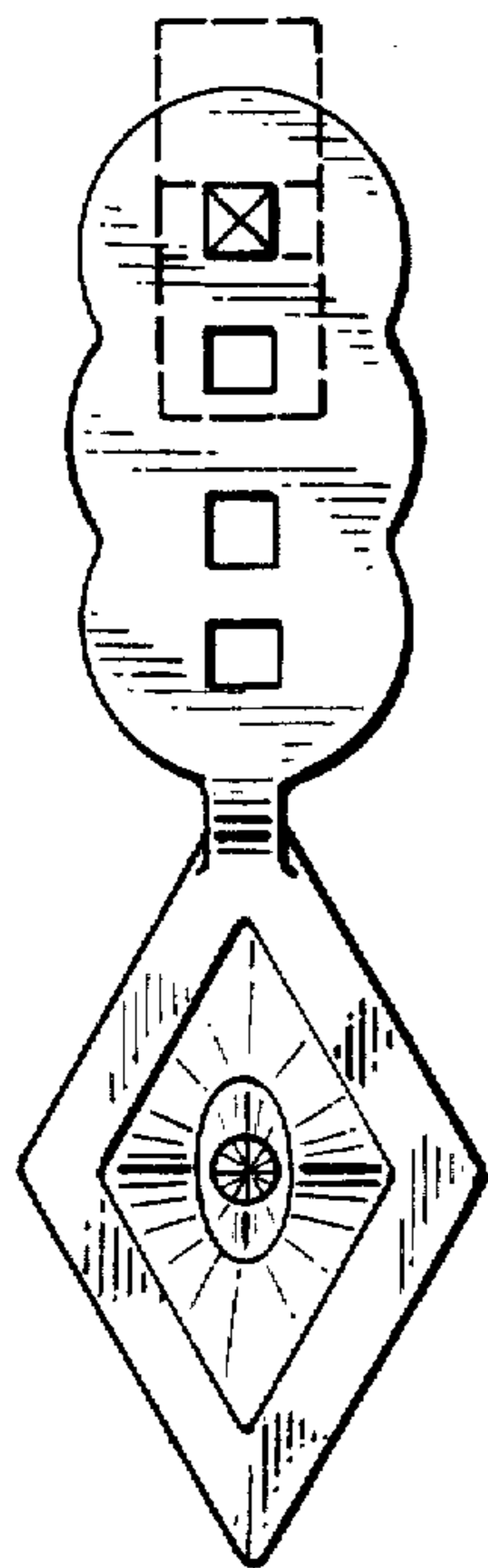

FIG.2

FIG.4

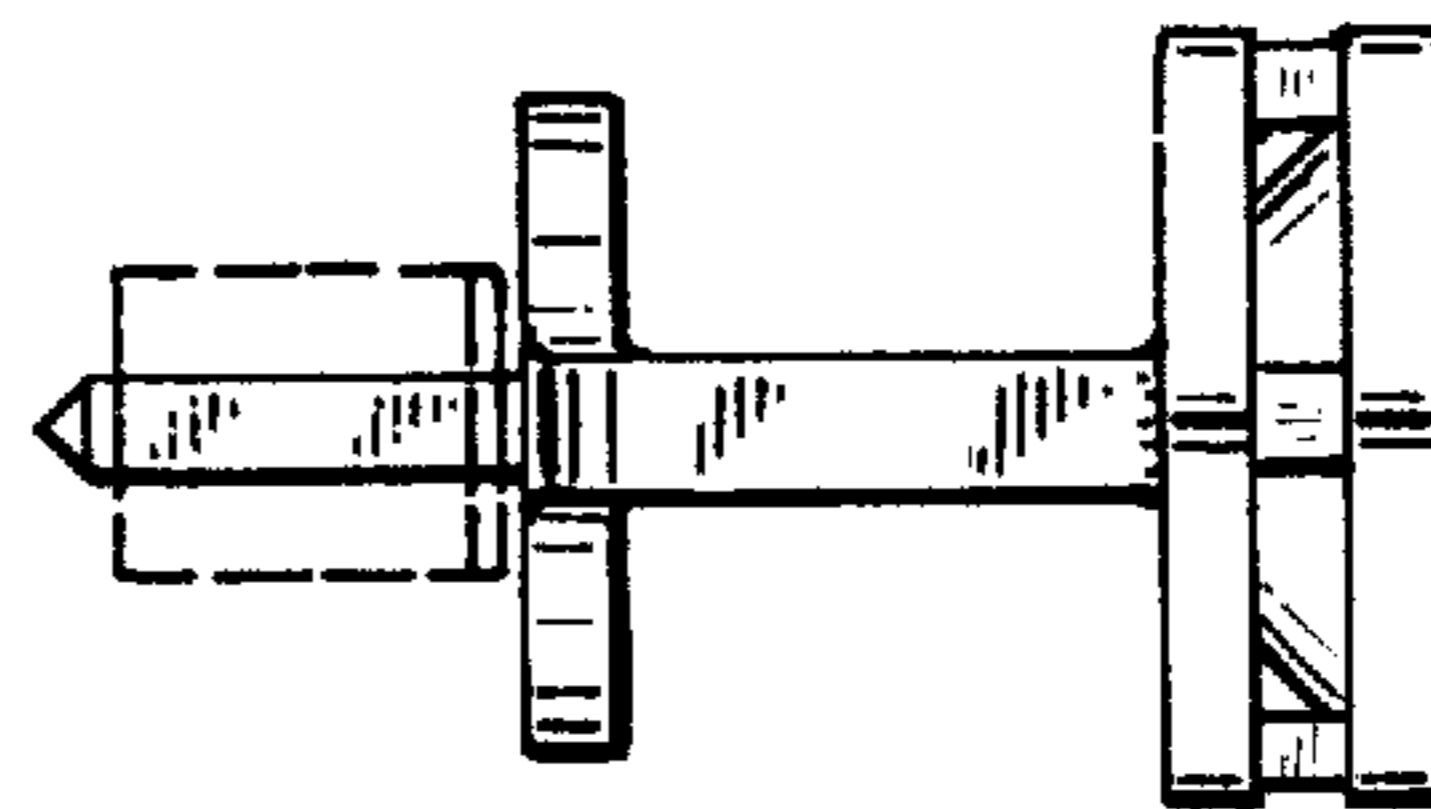
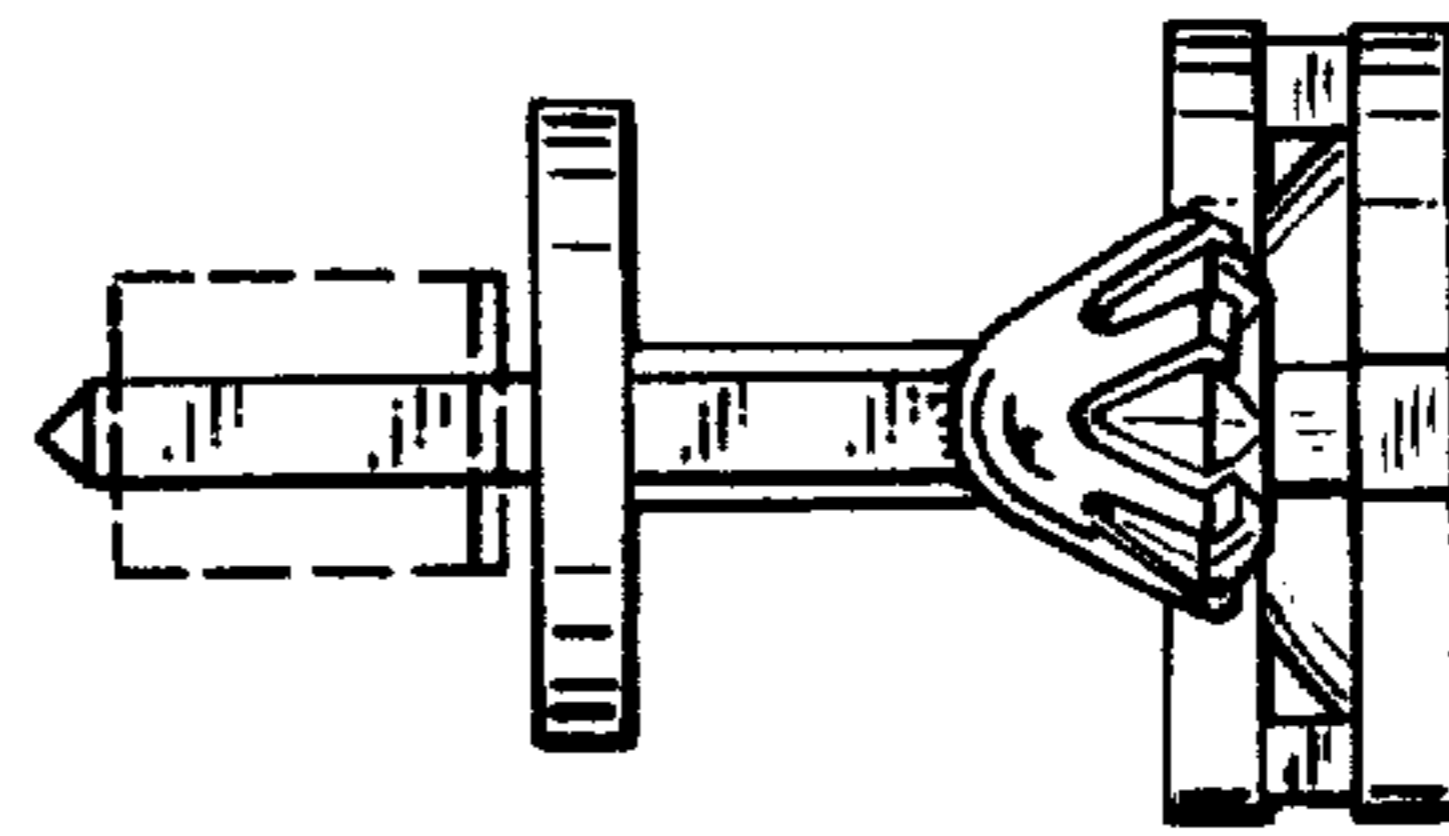

FIG.5