

[54] DISPENSING CONTAINER

[75] Inventor: Ira Schwartz, New York, N.Y.

[73] Assignee: Revlon, Inc., New York, N.Y.

[**] Term: 14 Years

[21] Appl. No.: 11,792

[22] Filed: Feb. 14, 1979

[51] Int. Cl. D9-01

[52] U.S. Cl. D9/353; D9/355

[58] Field of Search D9/2, 216, 275, 164,
D9/169, 37, 118

[56] References Cited

U.S. PATENT DOCUMENTS

D. 129,736 9/1941 Vuilleminot D9/169

D. 158,554 5/1950 Cady D9/169
D. 240,711 7/1976 Angleman et al. D9/169 X
2,826,297 3/1958 Hein, Jr. 206/572

Primary Examiner—Robert C. Spangler
Attorney, Agent, or Firm—Ernest B. Lipscomb, III;
Leon E. Tenenbaum; Gilbert W. Rudman

[57] CLAIM

The ornamental design for a dispensing container, as shown and described.

DESCRIPTION

FIG. 1 is a perspective view from the top of a dispensing container showing my new design;
FIG. 2 is a perspective view from the bottom thereof;
FIG. 3 is a front view thereof;
FIG. 4 is a top view thereof;
FIG. 5 is a bottom view thereof; and
FIG. 6 is an exploded view thereof.

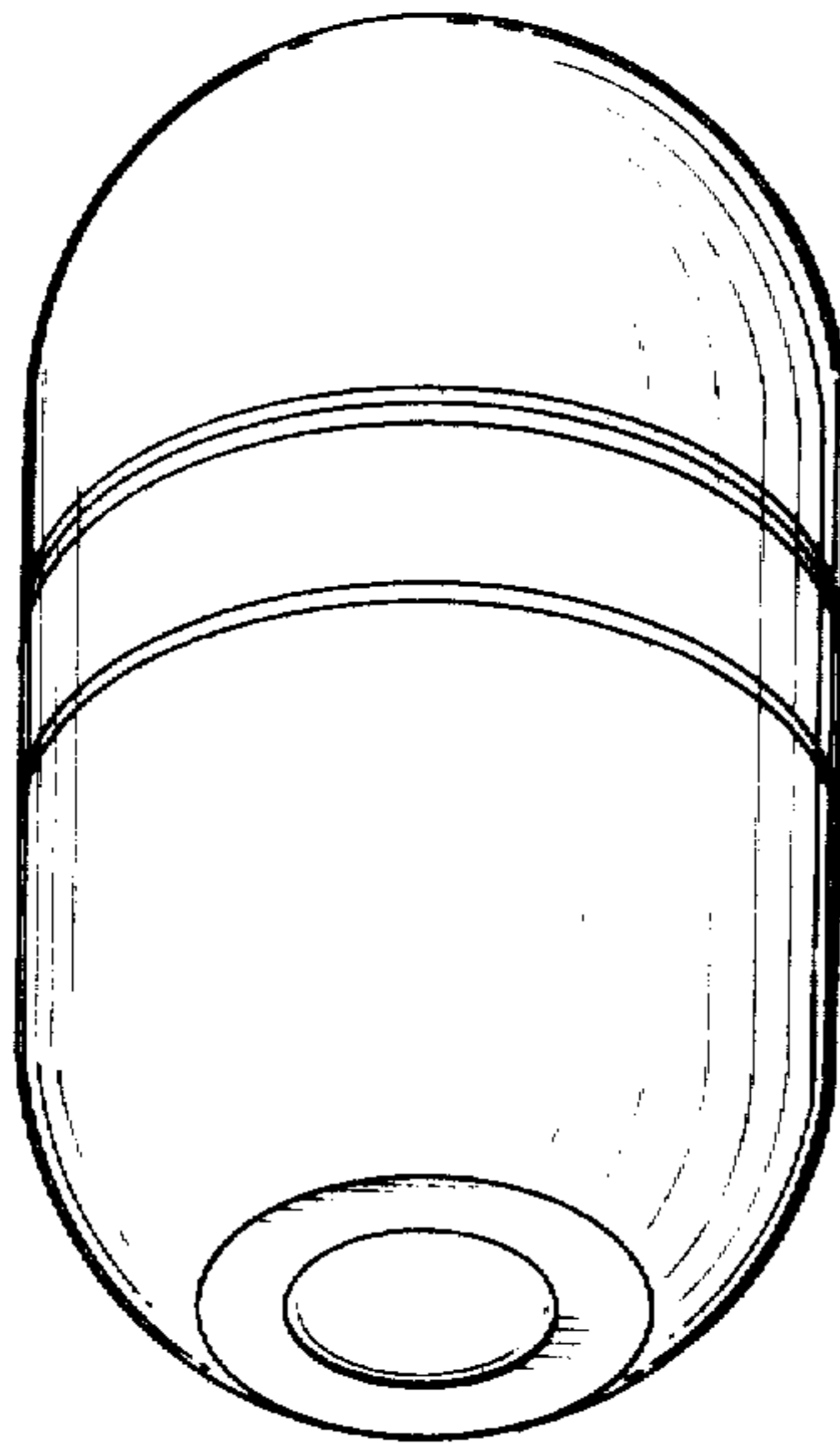

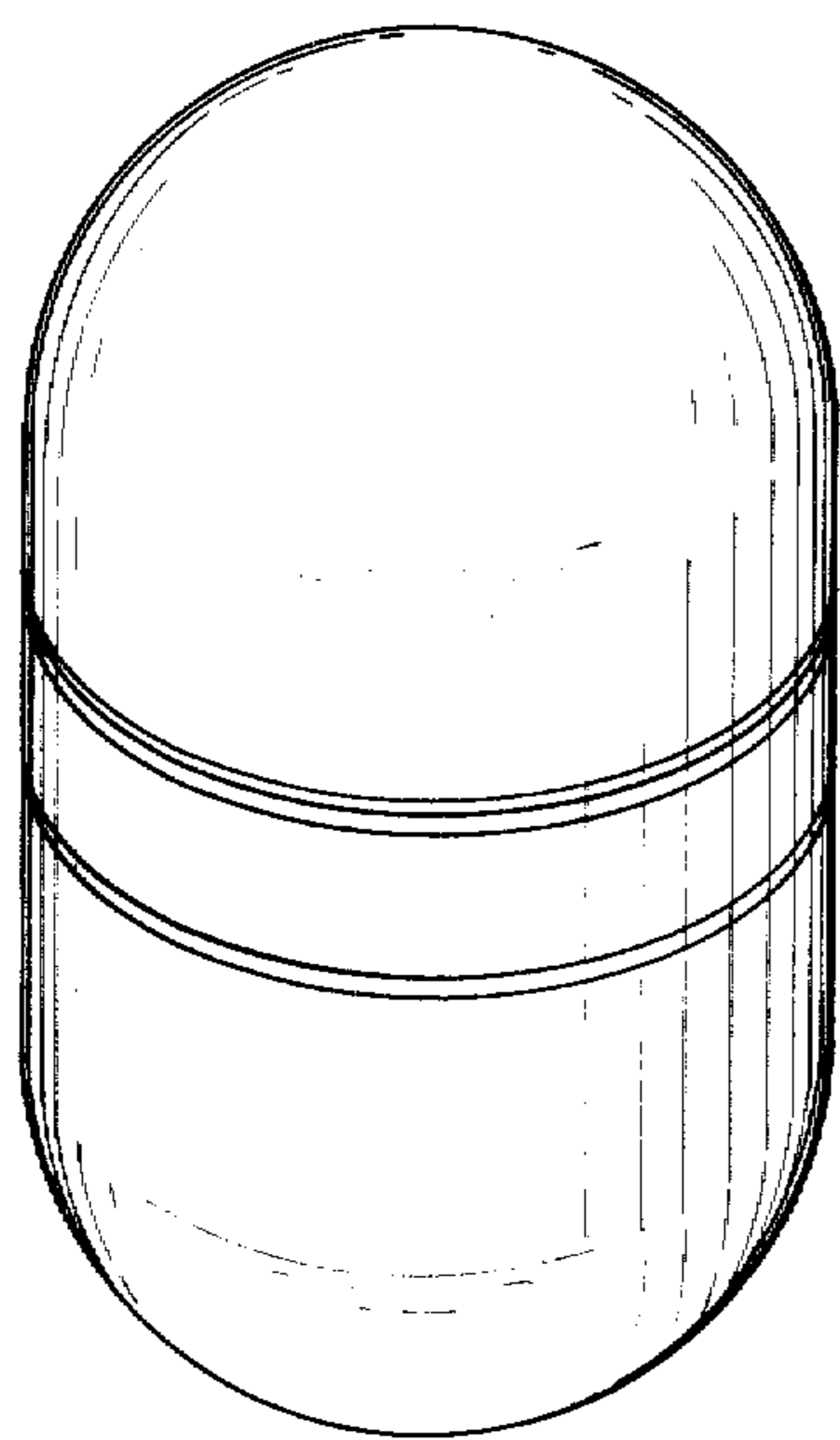

FIG. 1

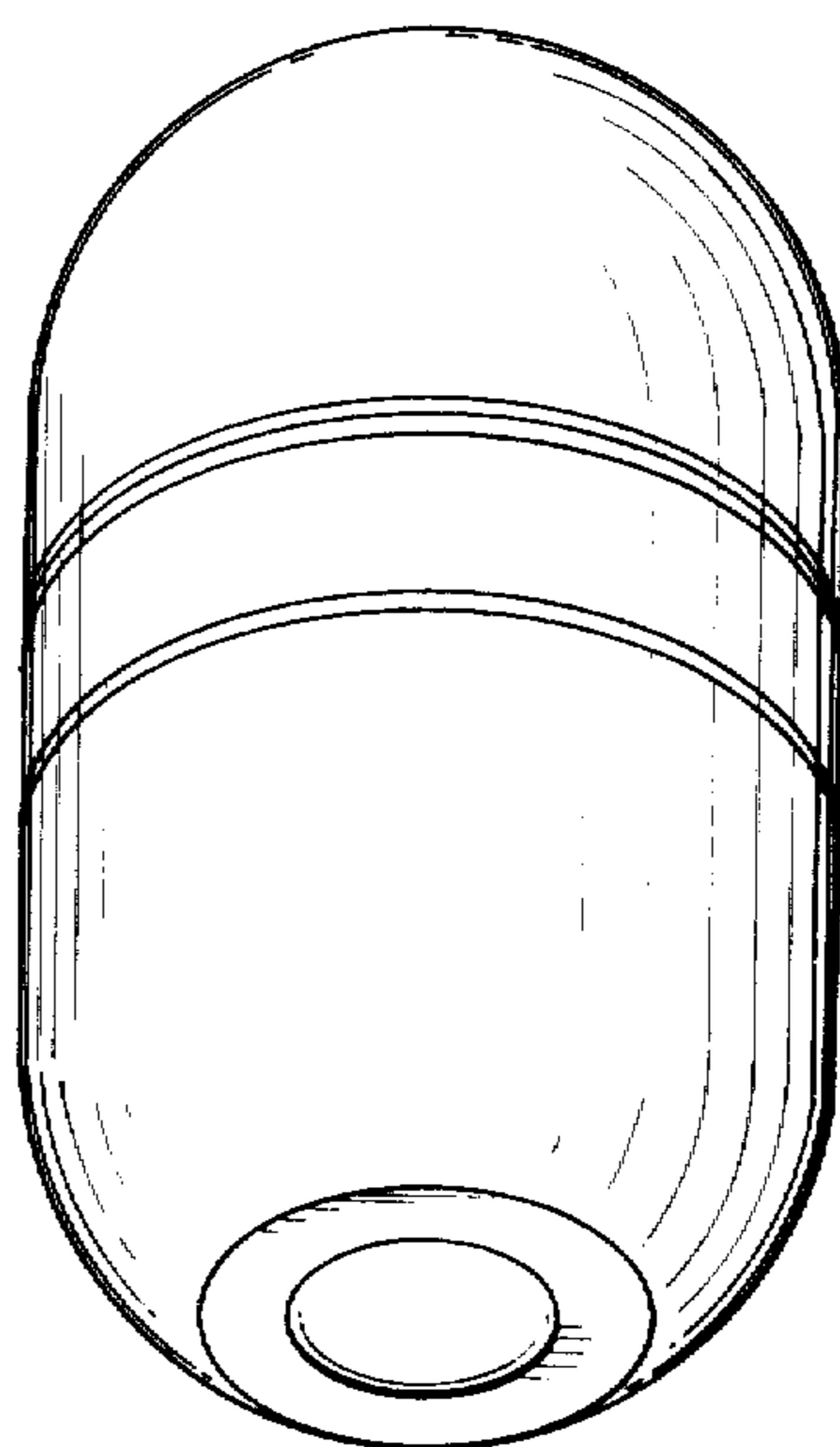

FIG. 2

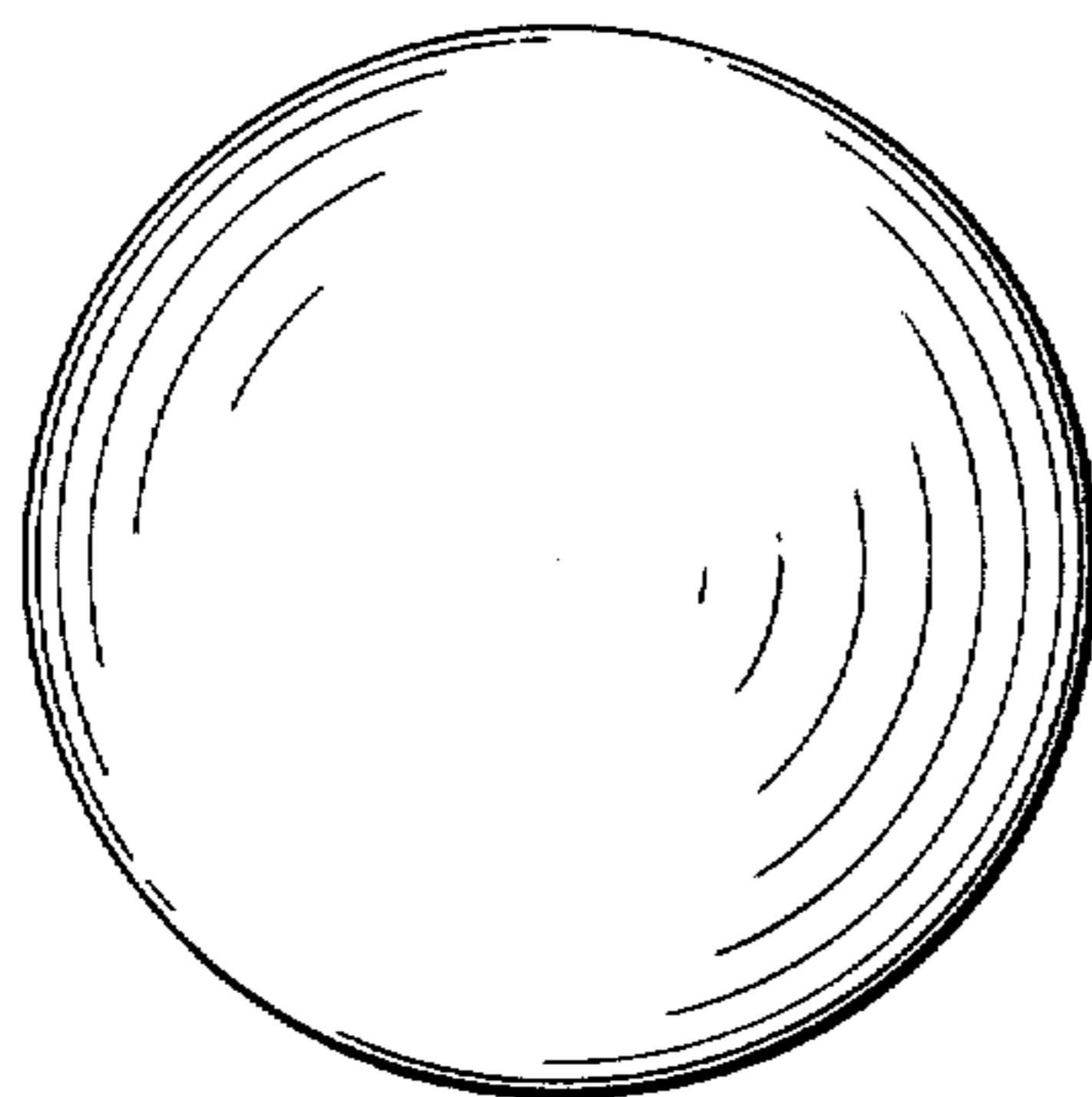

FIG. 4

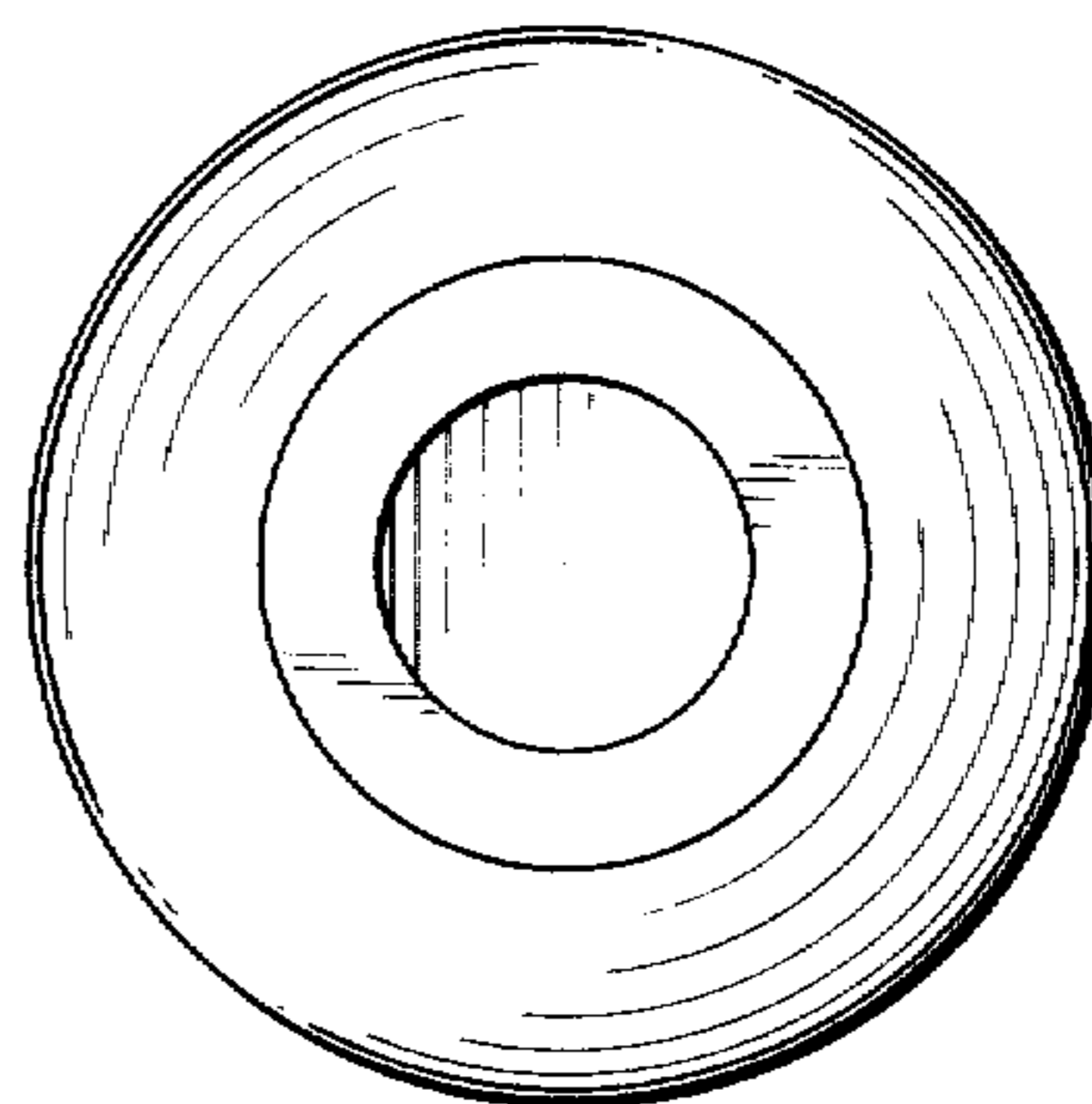

FIG. 5

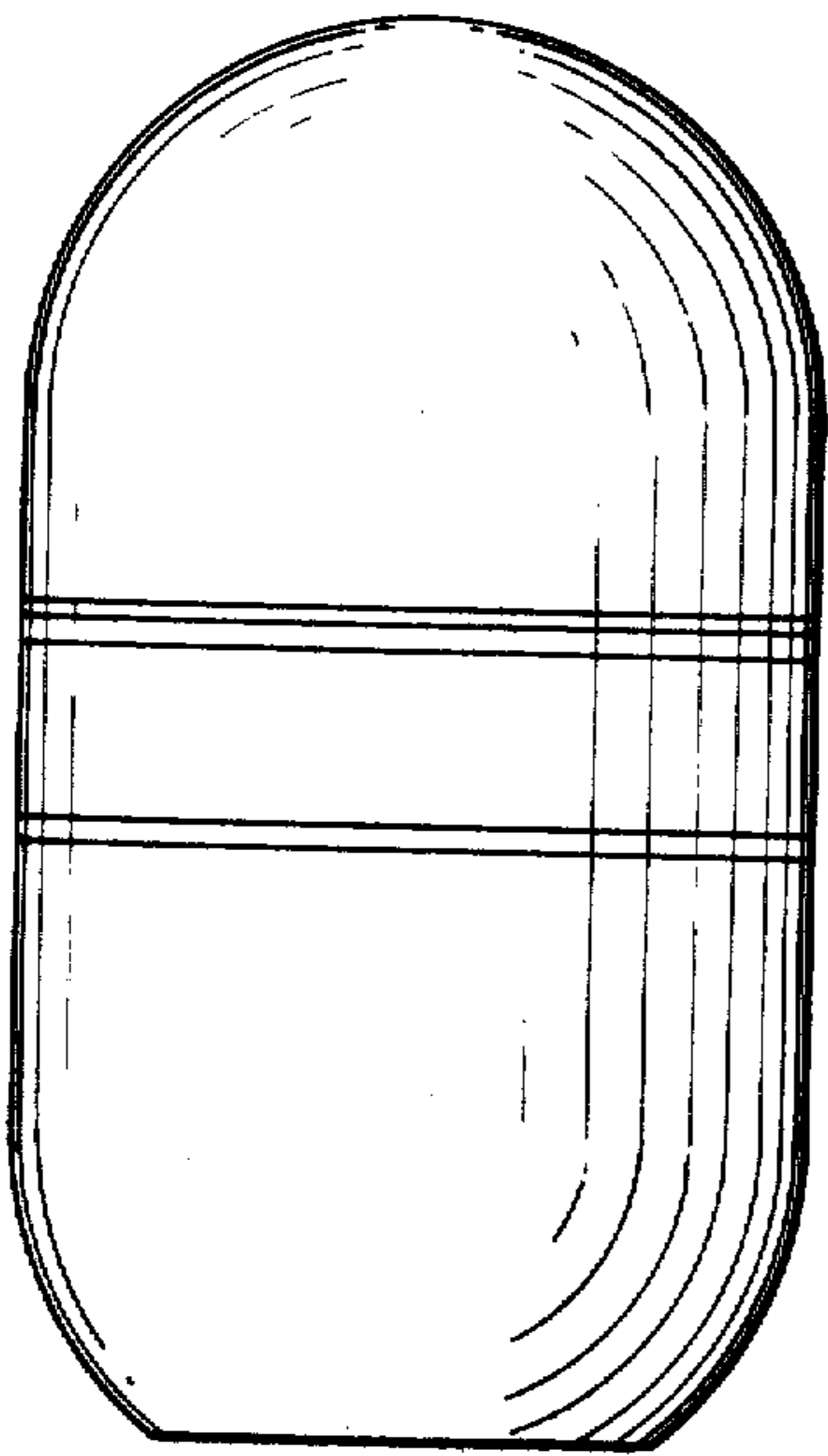

FIG. 3

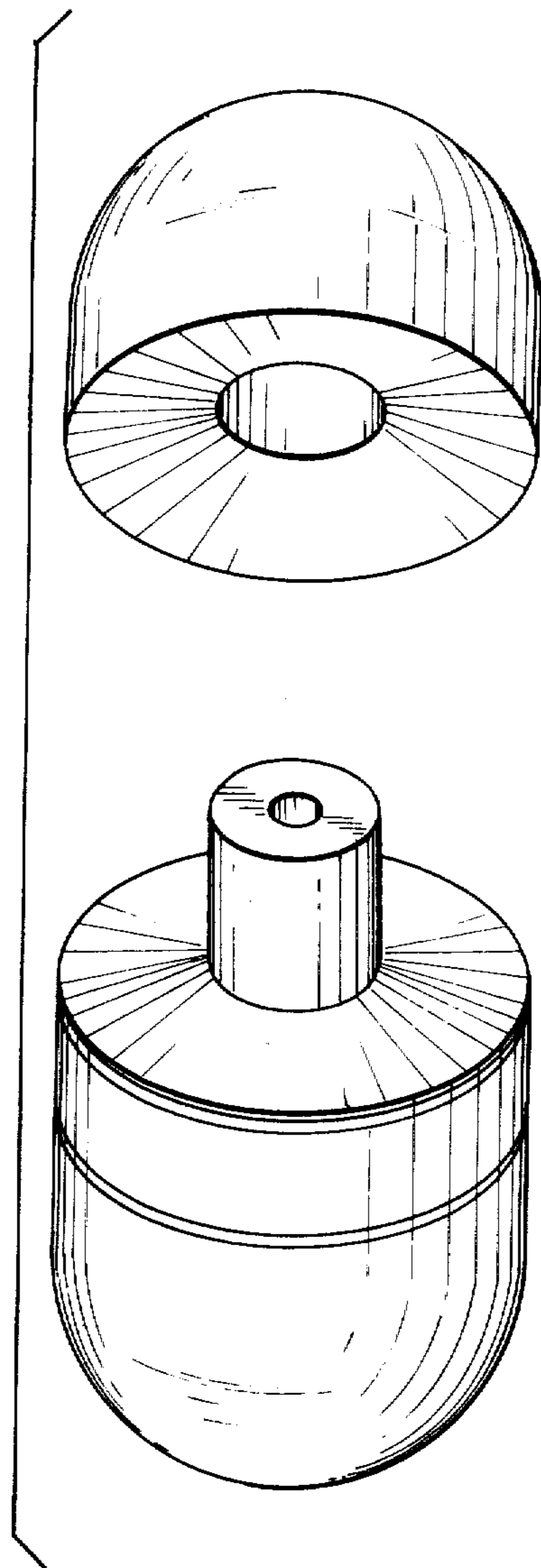

FIG. 6