

[54] STORAGE TANK FOR LIQUIDS OR THE LIKE

[75] Inventors: Keisaku Koga, Ibaraki; Takeshi Iseda, Yahata, both of Japan

[73] Assignee: Sekisui Koji Kabushiki Kaisha, Japan

[**] Term: 14 Years

[21] Appl. No.: 951,282

[22] Filed: Oct. 13, 1978

[30] Foreign Application Priority Data

Apr. 24, 1978 [JP] Japan 53-16615

[51] Int. Cl. D23-01

[52] U.S. Cl. D23/2

[58] Field of Search D9/175, 246; D23/2; 220/1 B

[56] References Cited

U.S. PATENT DOCUMENTS

D. 51,545 12/1917 Blake D23/2
D. 239,506 4/1976 Myers D9/175

D. 245,319 8/1977 Wodell D9/246
D. 251,674 4/1979 Sayward D23/2

Primary Examiner—Robert C. Spangler
Attorney, Agent, or Firm—William B. Cunningham, Jr.

[57] CLAIM

The ornamental design for a storage tank for liquids or the like, as shown and described.

DESCRIPTION

FIG. 1 is a perspective view of a storage tank for liquids or the like showing our new design;
FIG. 2 is a top plan view;
FIG. 3 is a front elevational view;
FIG. 4 is an elevational view looking from the left of FIG. 3, the opposite side being a mirror image of the side shown;
FIG. 5 is a rear elevational view;
FIG. 6 is a bottom plan view;
FIG. 7 is a horizontal sectional view taken along line 7—7 of FIG. 3; and
FIG. 8 is a vertical sectional view taken along line 8—8 of FIG. 4.

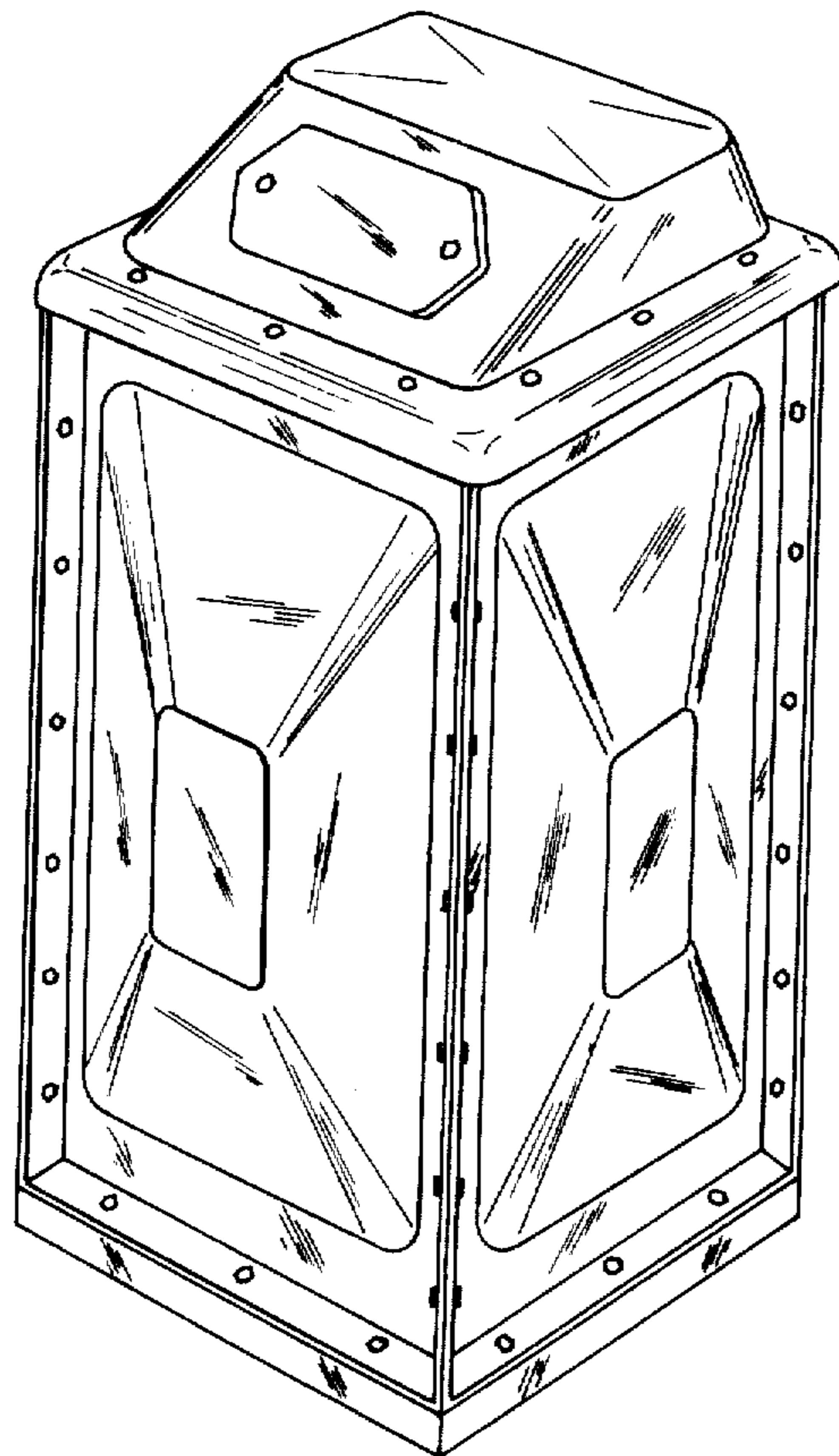

FIG. 1

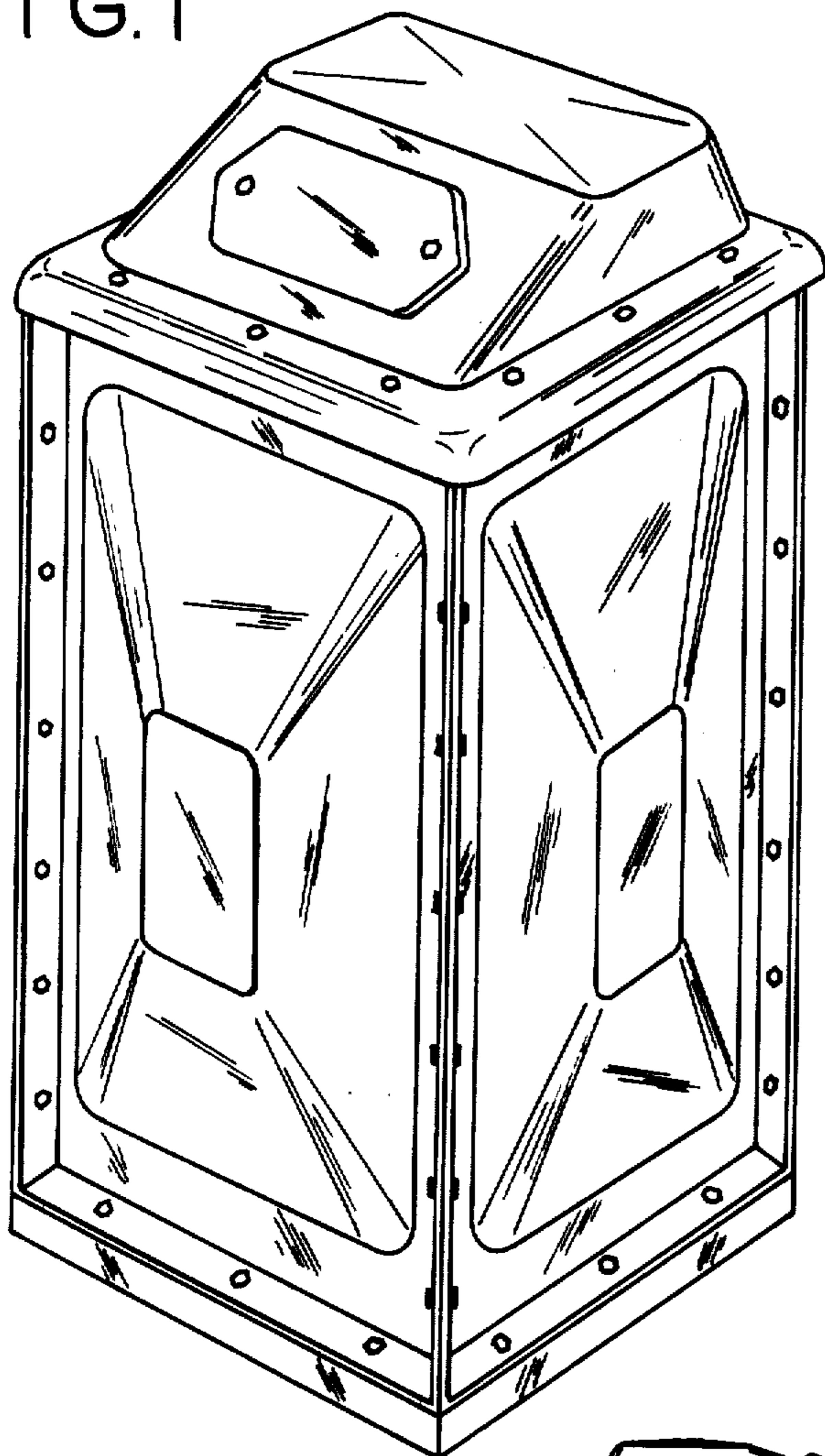

FIG. 2

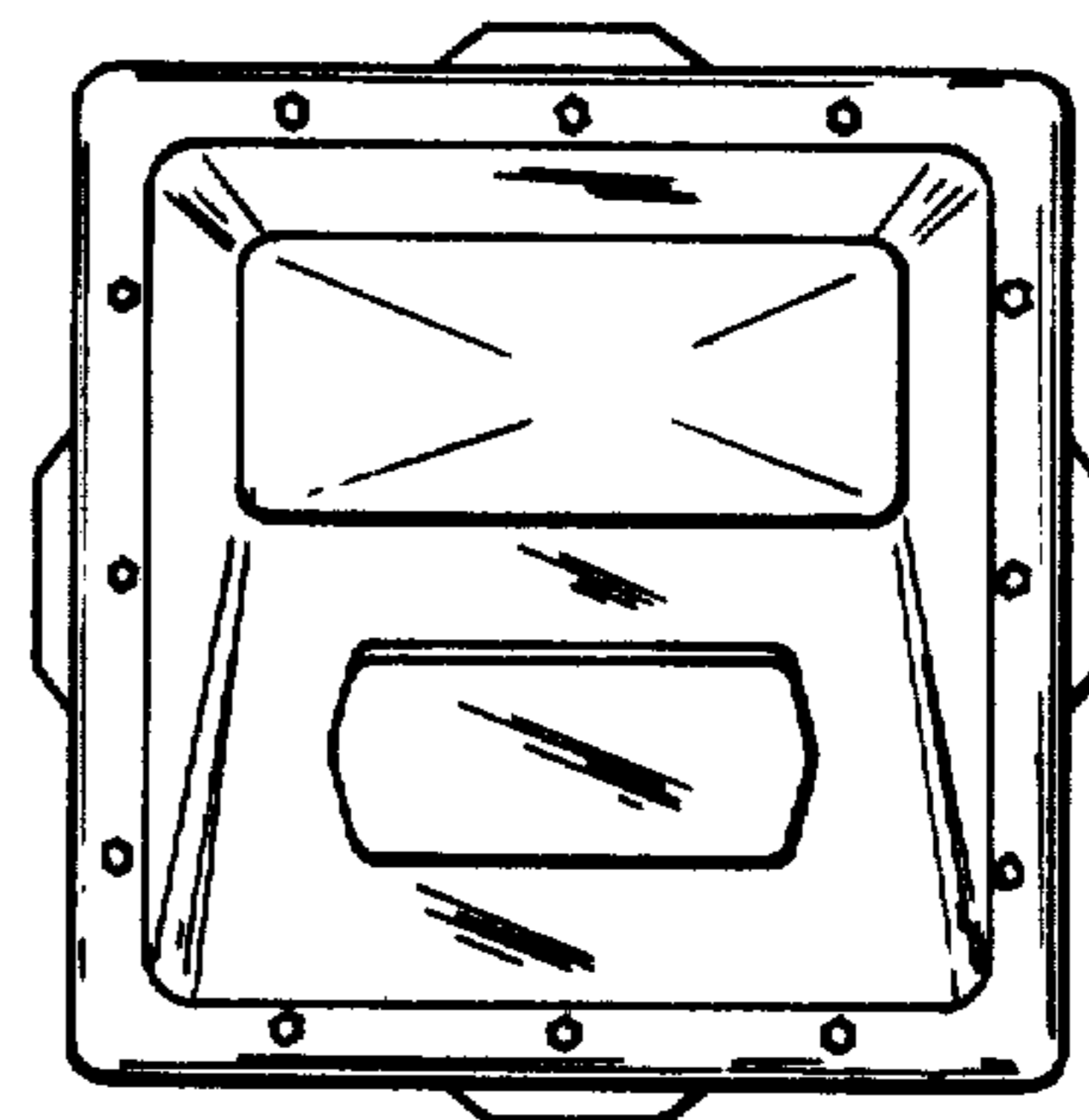

FIG. 3

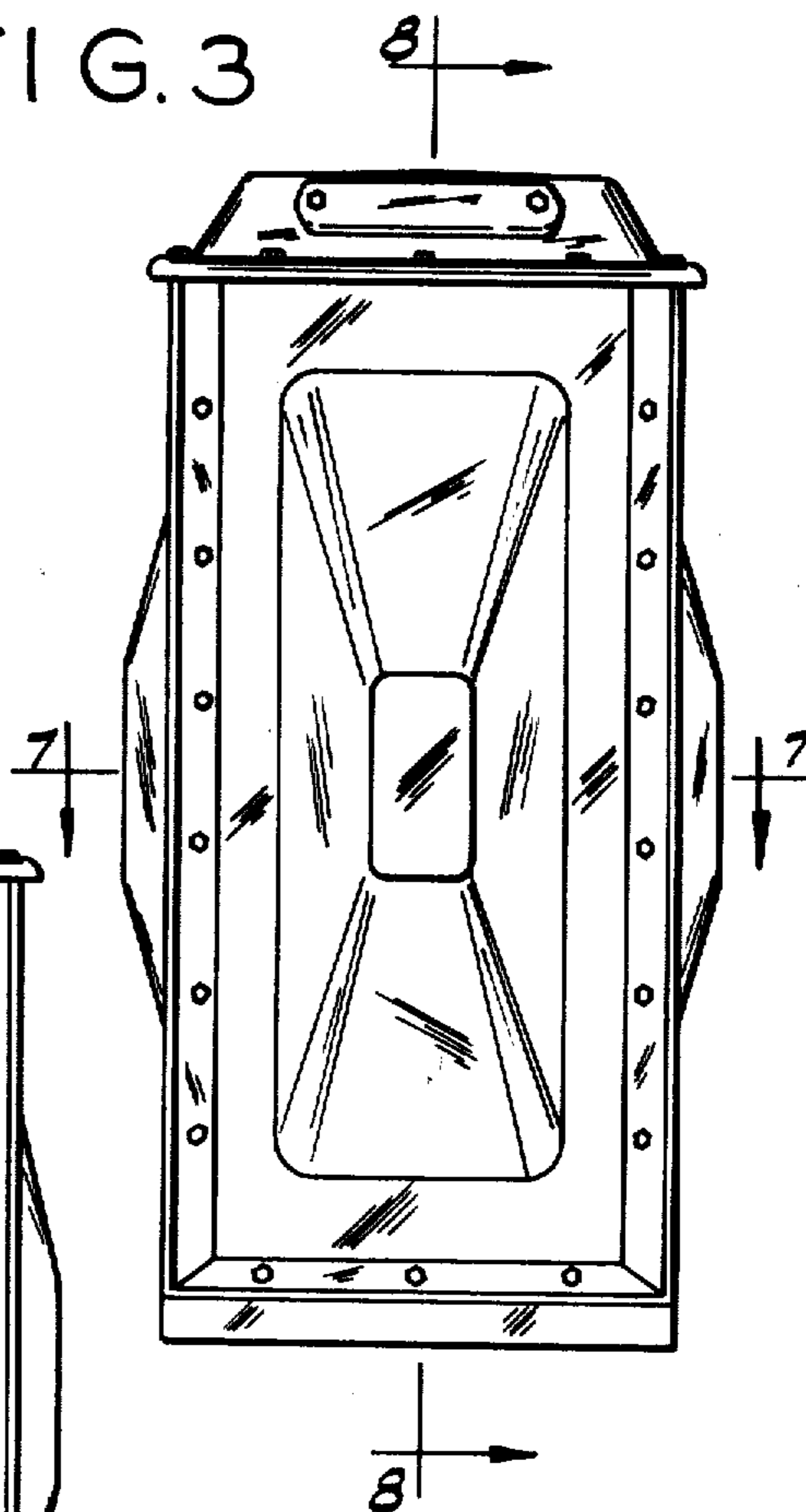

FIG. 4

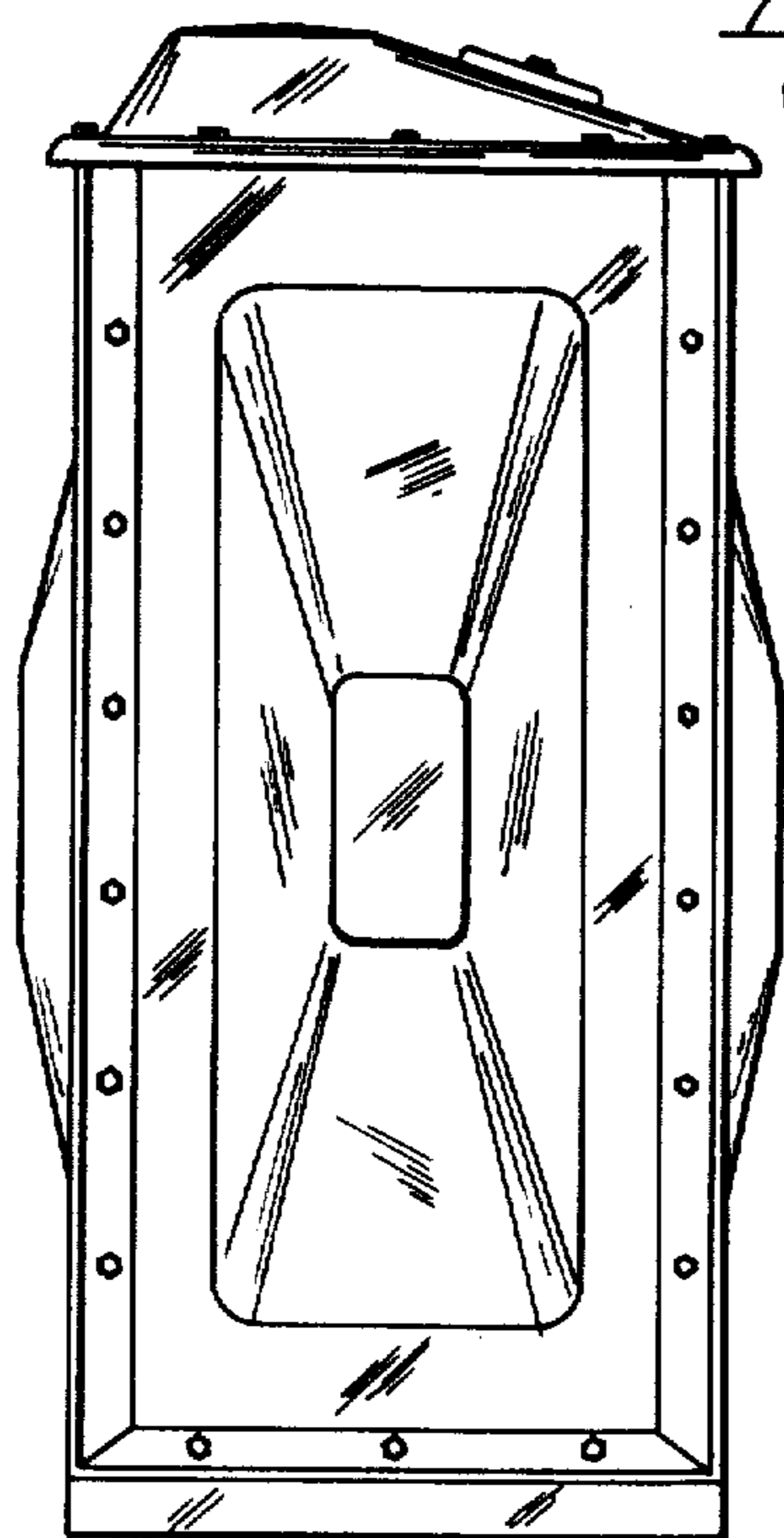

FIG. 5

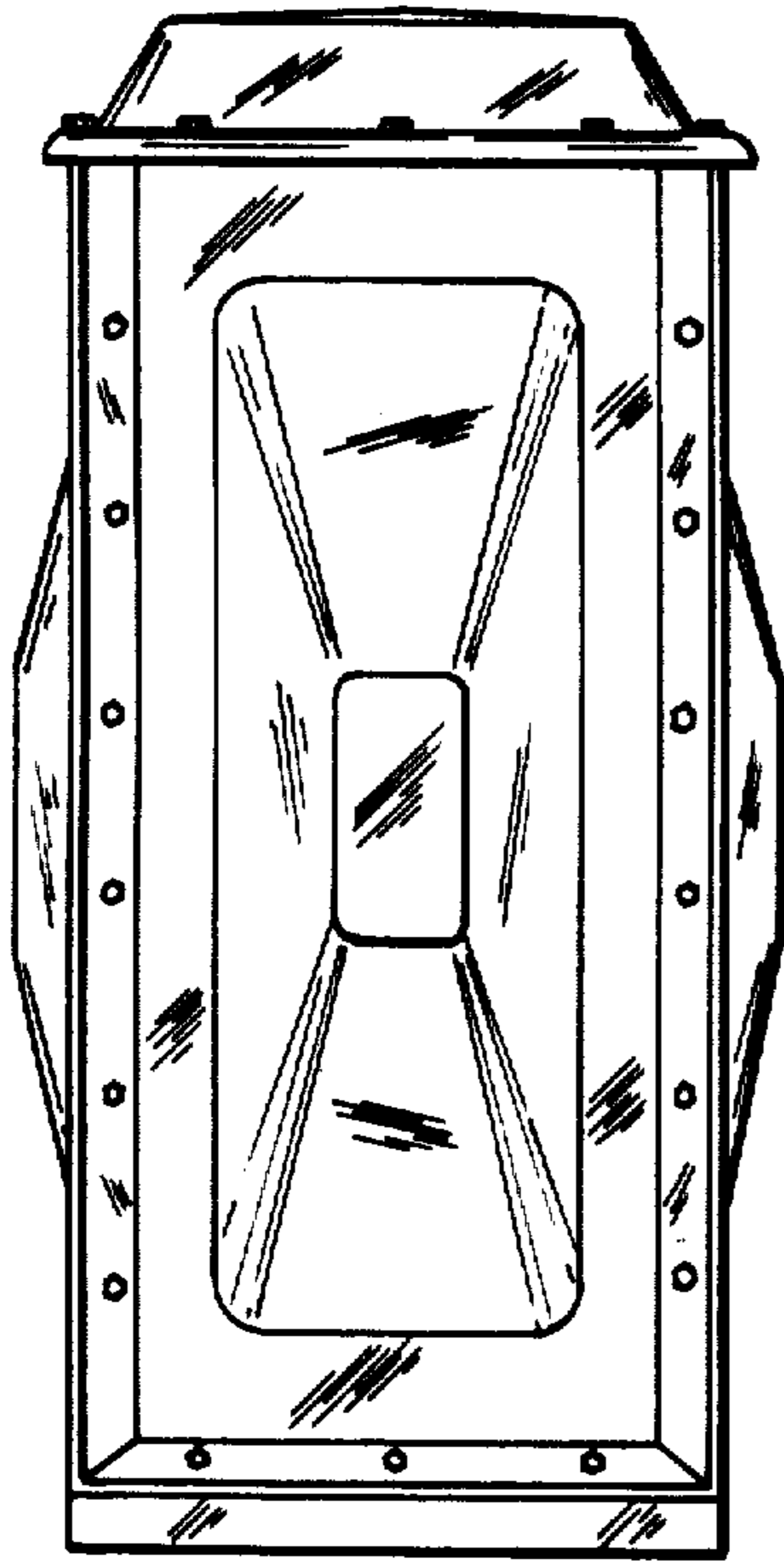

FIG. 6

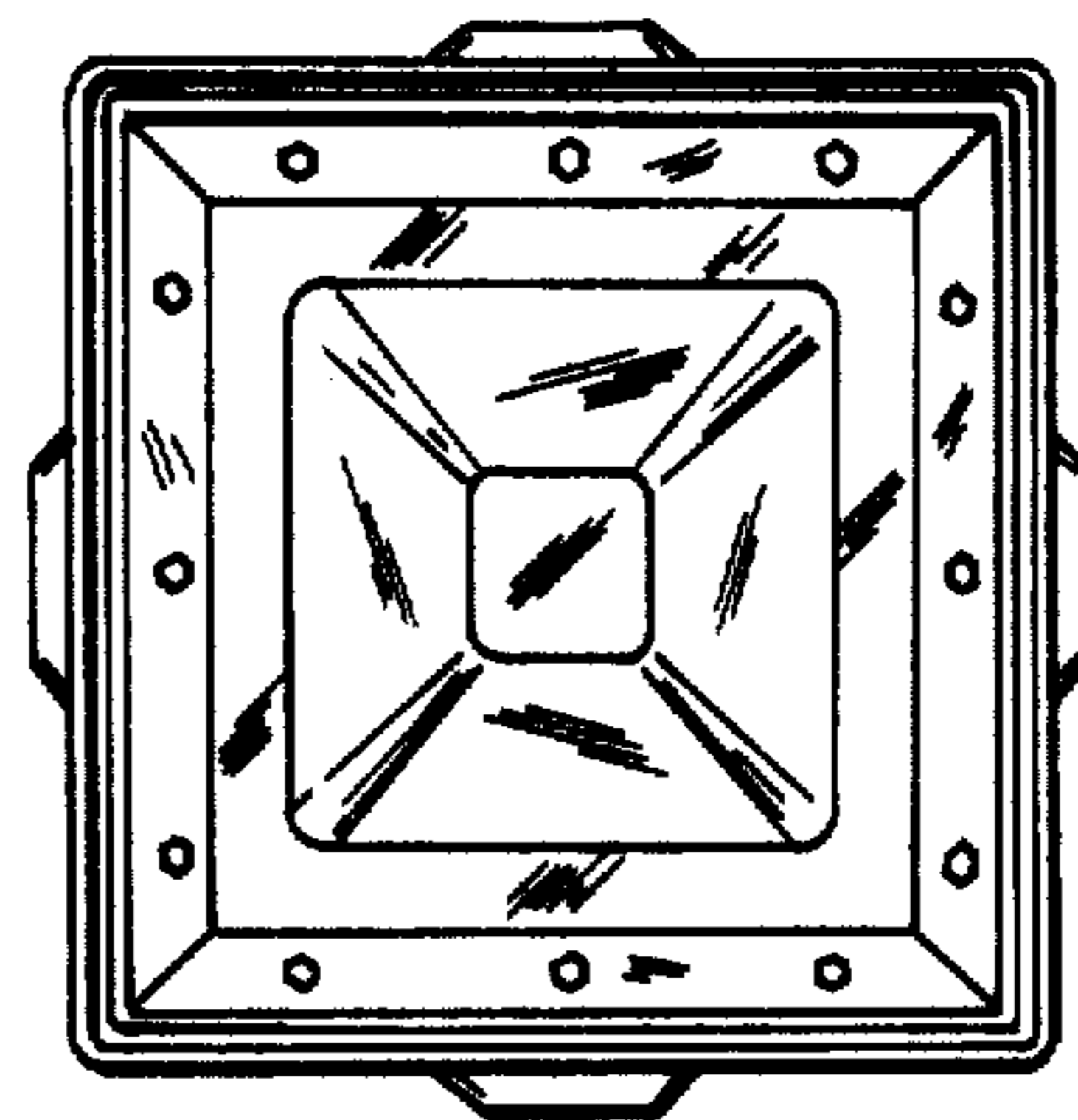

FIG. 8

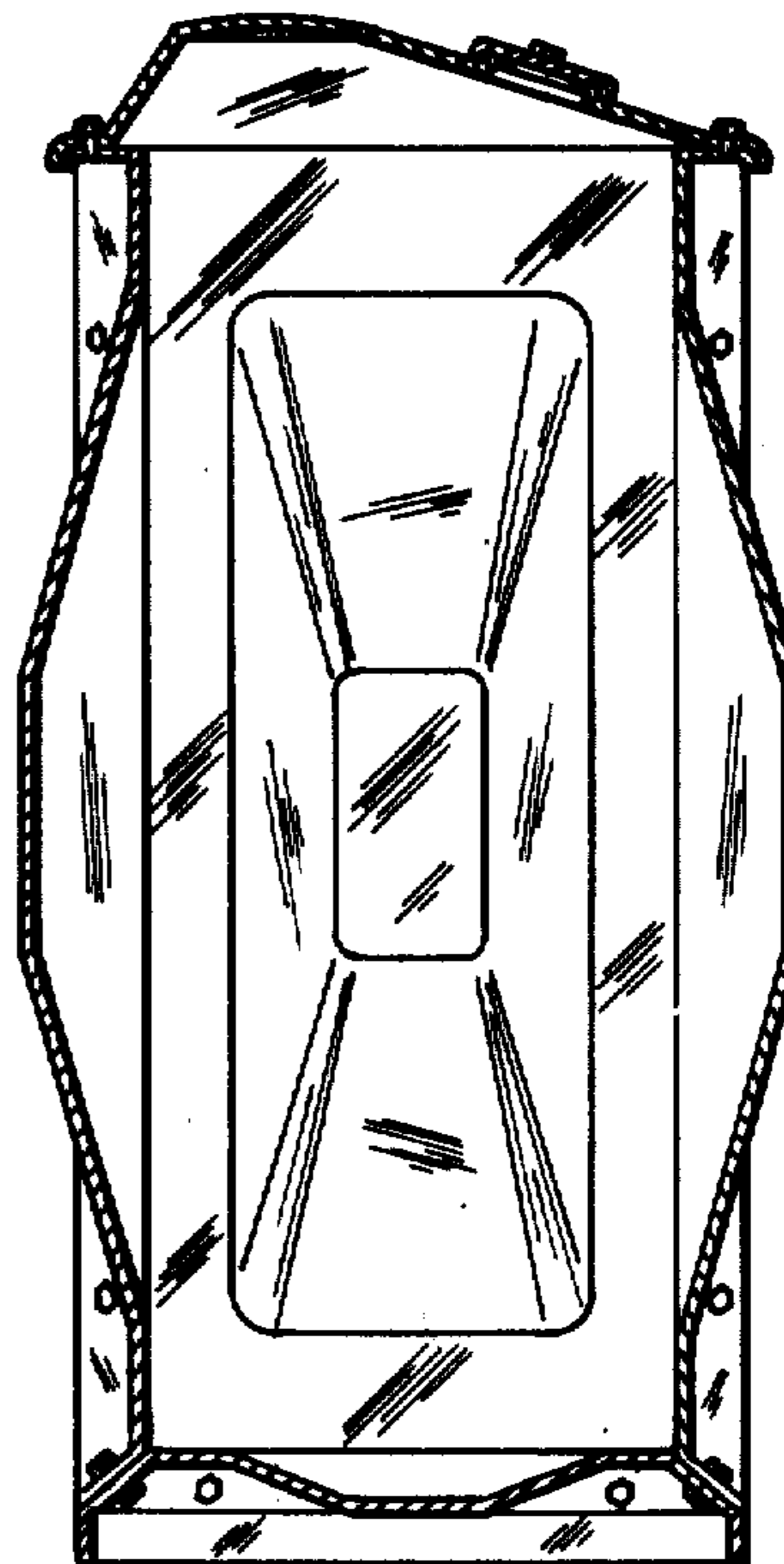

FIG. 7

