

[54] CAMERA WITH INTEGRATED FLASH

[75] Inventors: James T. Asaki, Middletown; William G. MacKenzie, Matawan, both of N.J.

[73] Assignee: International Telephone and Telegraph Corporation, New York, N.Y.

[\*\*] Term: 14 Years

[21] Appl. No.: 930,770

[22] Filed: Aug. 3, 1978

[51] Int. Cl. .... D16-01

[52] U.S. Cl. .... D16/06

[58] Field of Search ..... D16/1-10; 354/126, 145, 152, 158, 170, 173, 174, 187, 202, 288

[56] References Cited

U.S. PATENT DOCUMENTS

D. 236,851	9/1975	Quinn	.....	D16/5
D. 250,120	10/1978	Munakata et al.	.....	D16/6
3,938,170	2/1976	Winkler et al.	.....	354/187 X
4,032,940	6/1977	Chan	.....	354/187 X

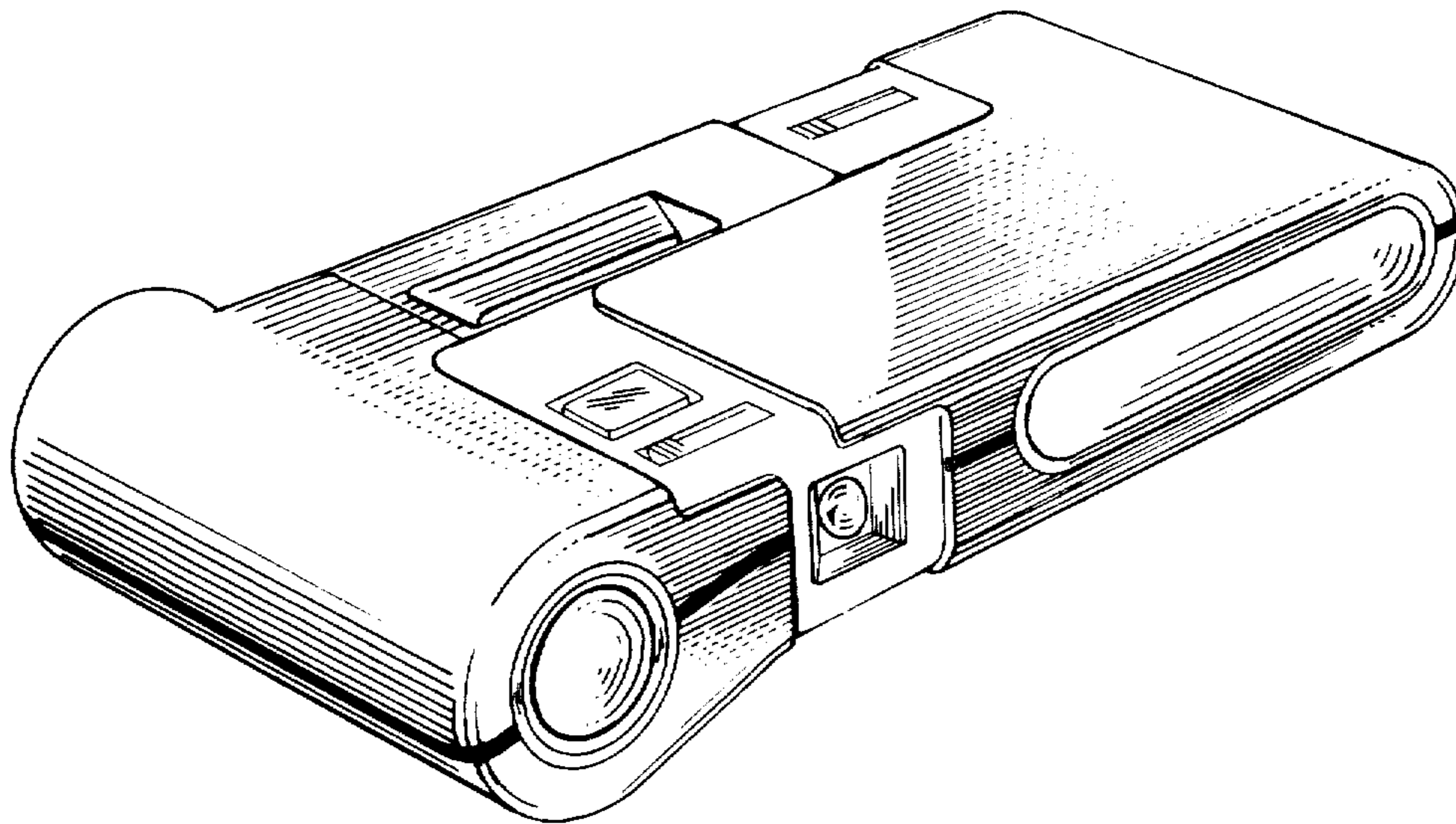
Primary Examiner—Catherine E. Kemper  
Attorney, Agent, or Firm—John T. O'Halloran

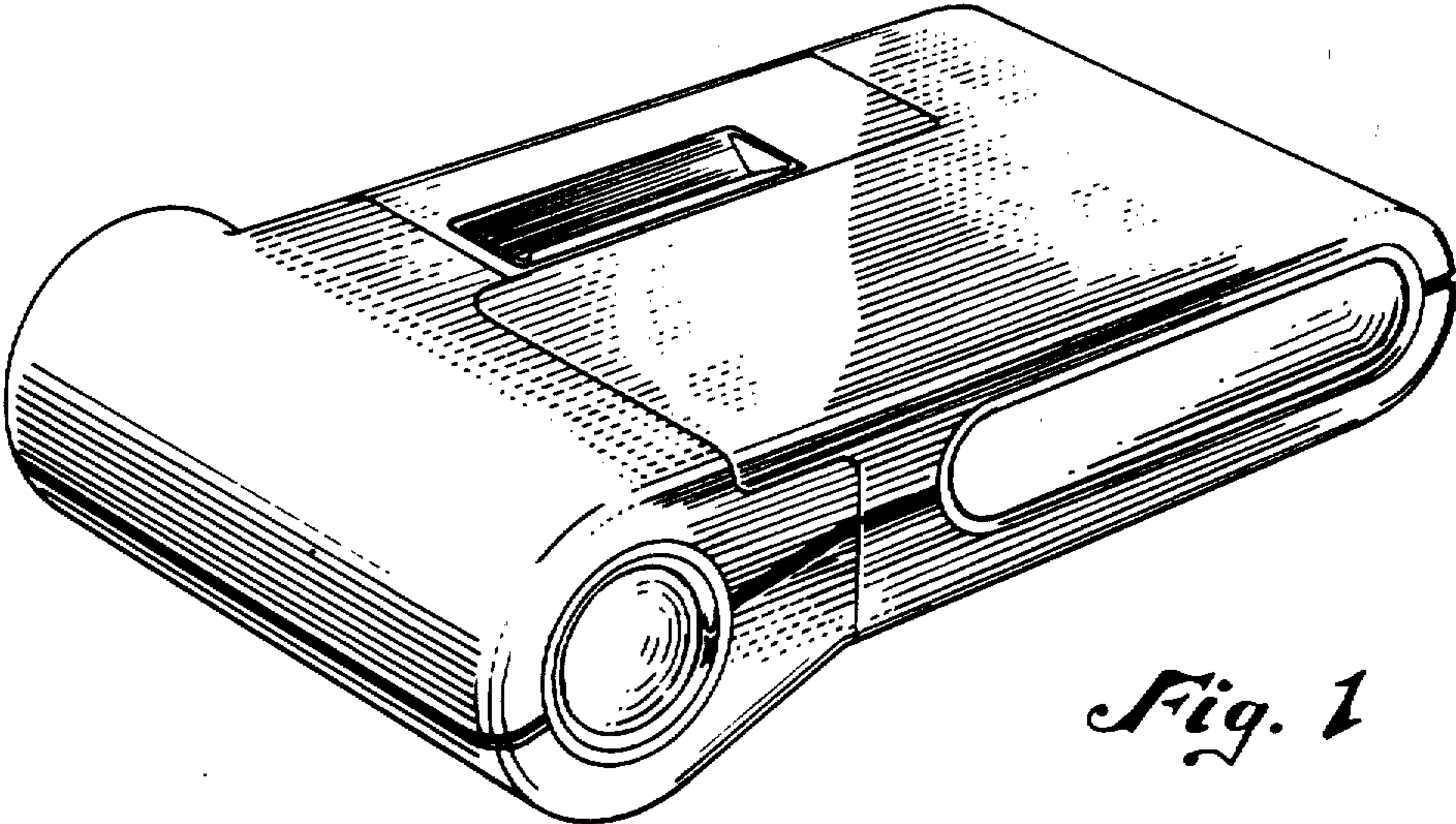
[57] CLAIM

The ornamental design for a camera with integrated flash, substantially as shown and described.

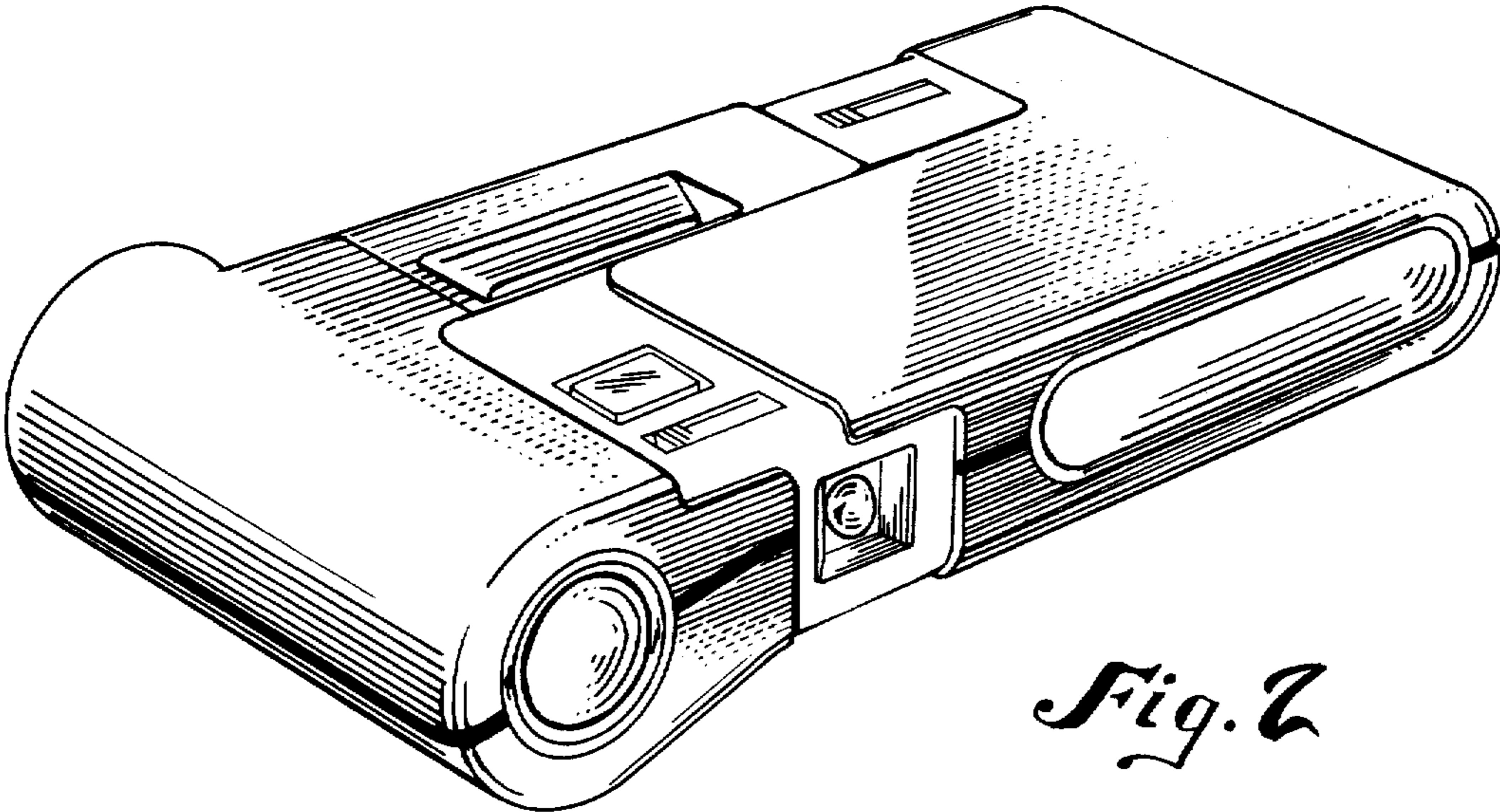
DESCRIPTION

FIG. 1a is a perspective view of the camera of the present invention shown in the closed position;  
 FIG. 1b is perspective view of the camera shown in FIG. 1a in the open position;  
 FIG. 2a is a front view of a camera of FIG. 1a shown in the closed position;  
 FIG. 2b is a front view of the camera shown in FIG. 1b in the open position;  
 FIG. 3a is a top view of the camera in FIG. 1a shown in the closed position;  
 FIG. 3b is a top view of the camera in FIG. 1b shown in the open position;  
 FIG. 4a is a rear view of the camera in FIG. 1a shown in the closed position;  
 FIG. 4b is a rear view of the camera in FIG. 1b shown in the open position;  
 FIG. 5 is a left end view of the camera shown in FIG. 1a;  
 FIG. 6 is a right end view of the camera shown in FIG. 1a;  
 FIG. 7a is a bottom view of the camera shown in FIG. 1a in the closed position;  
 FIG. 7b is a bottom view of the camera shown in FIG. 1b in the open position.

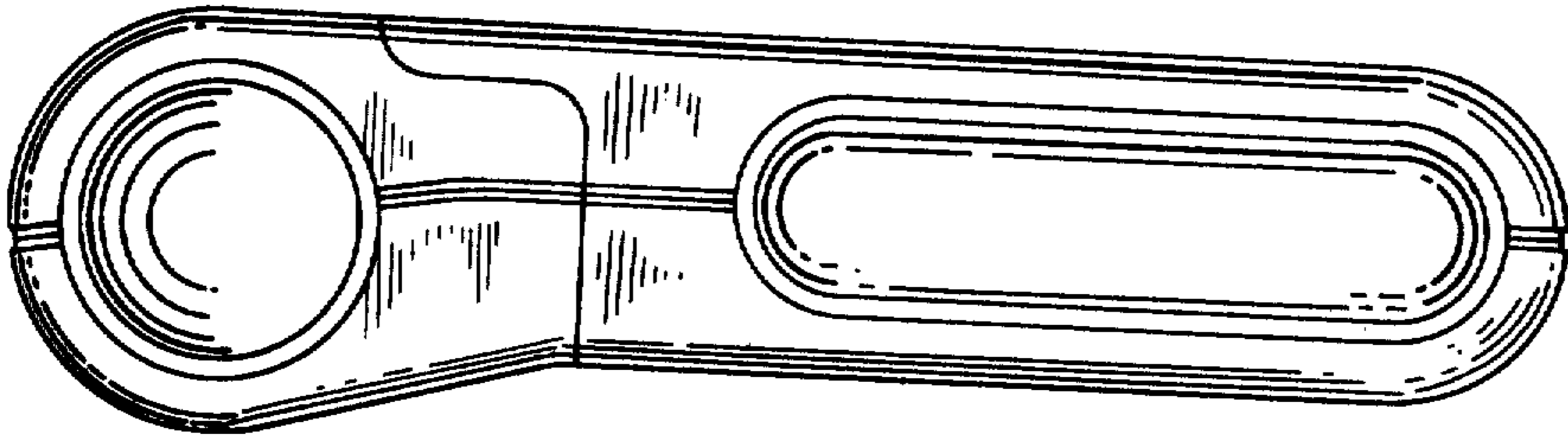




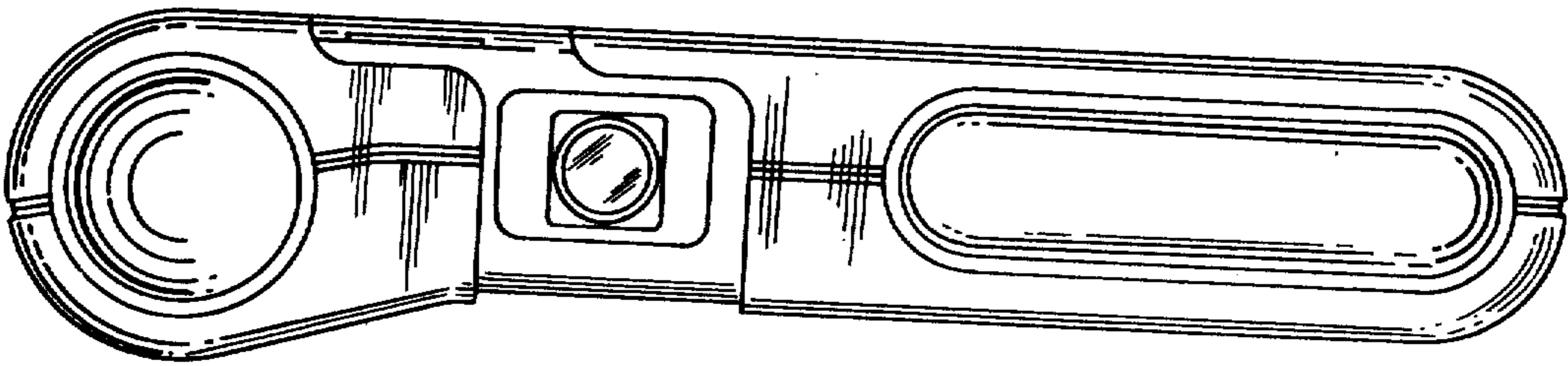
*Fig. 1*



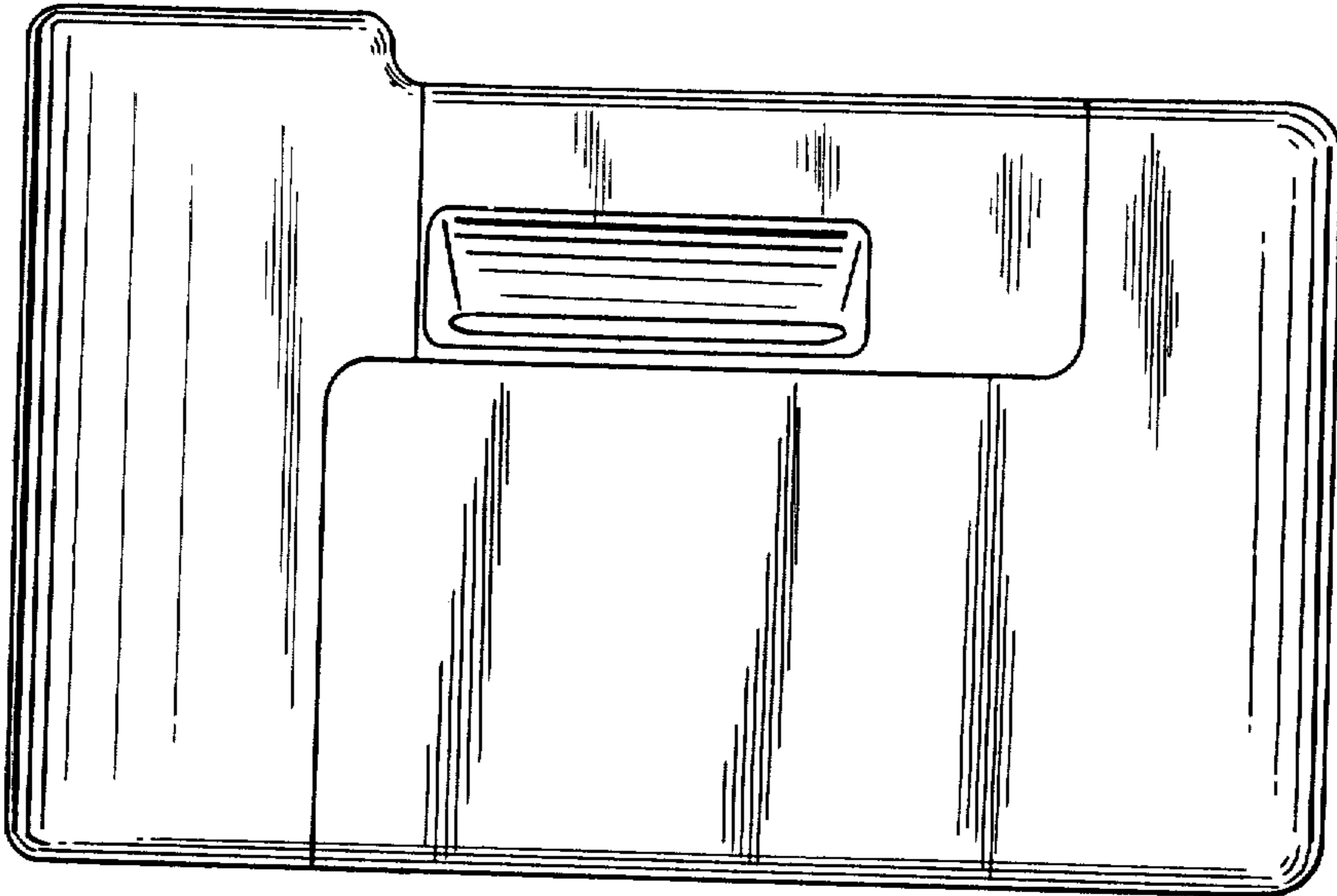
*Fig. 2*



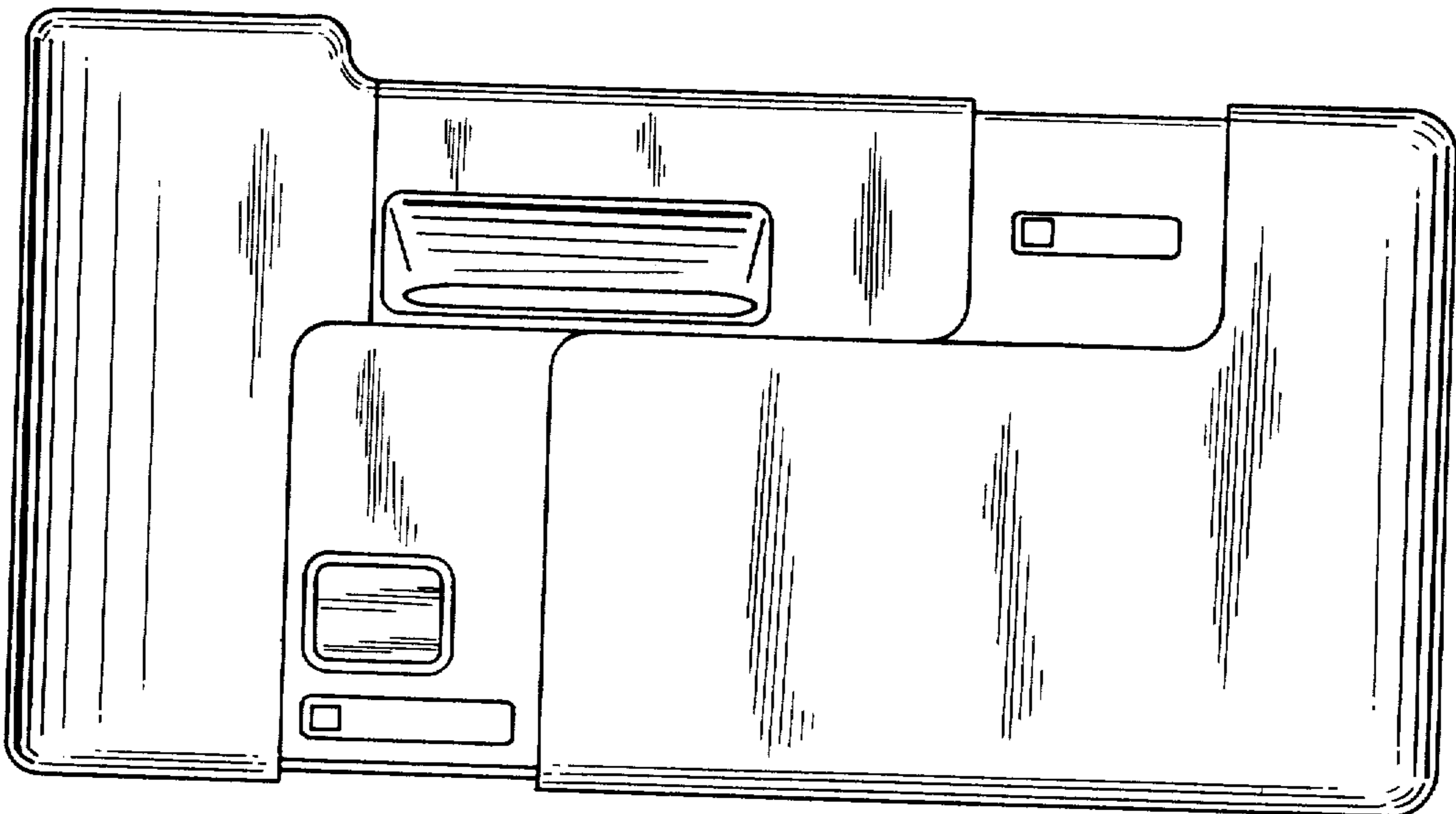
*Fig. 3*



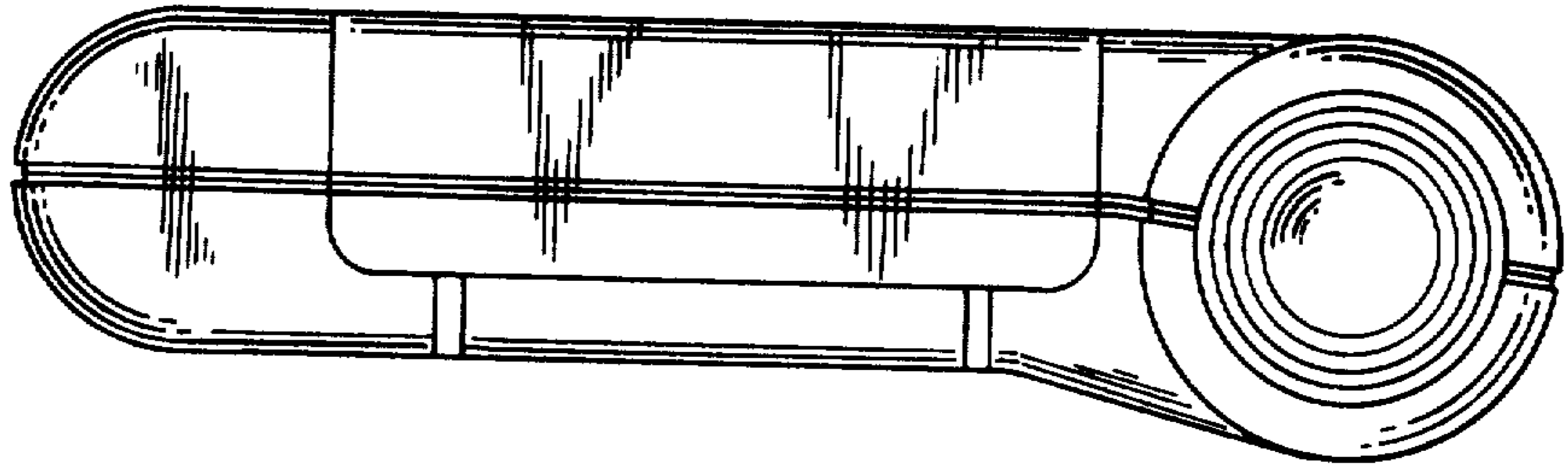
*Fig. 4*



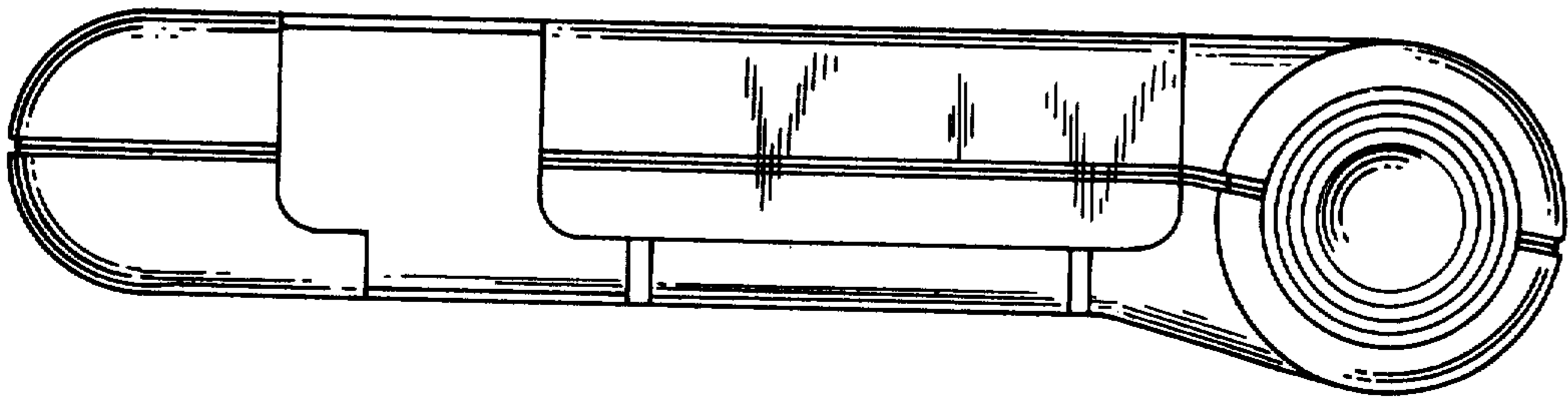
*Fig. 5*



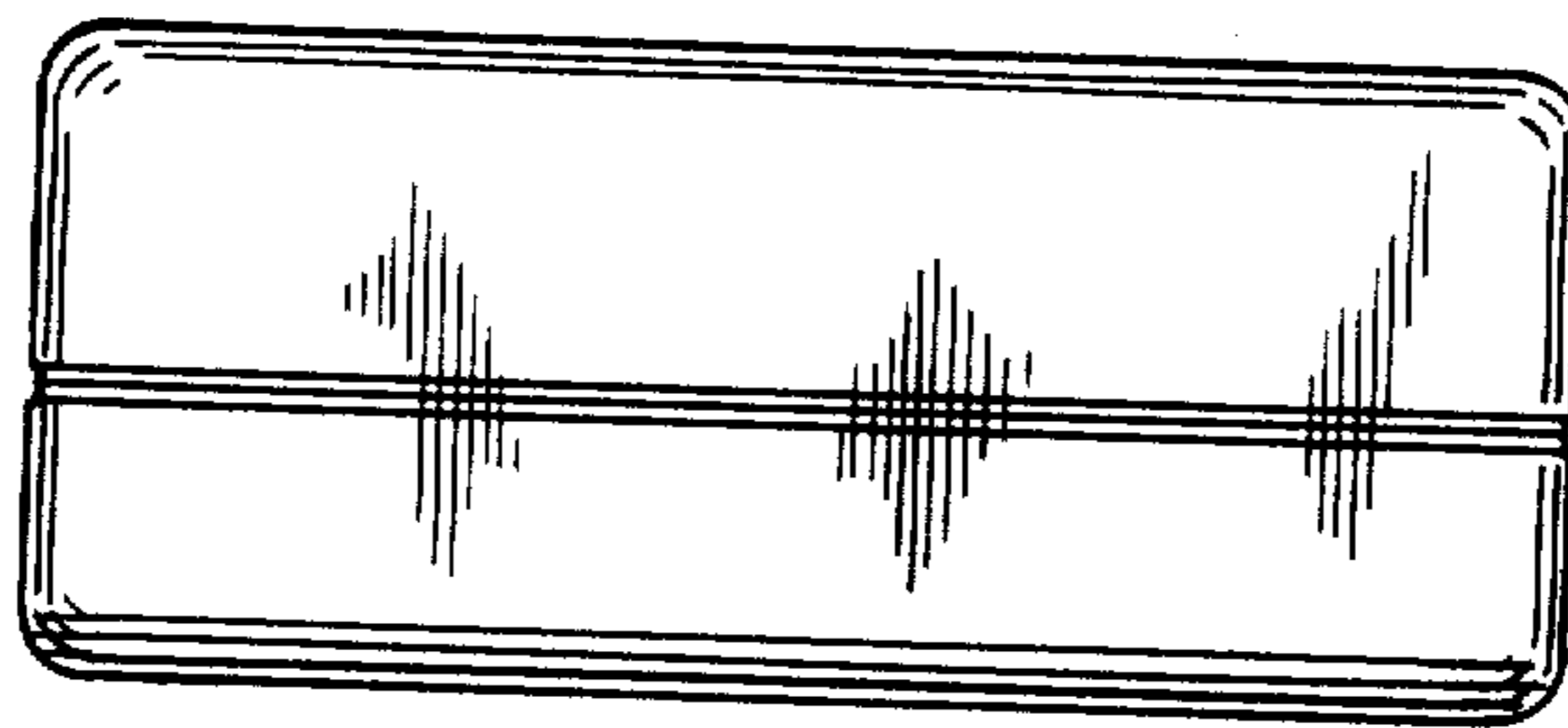
*Fig. 6*



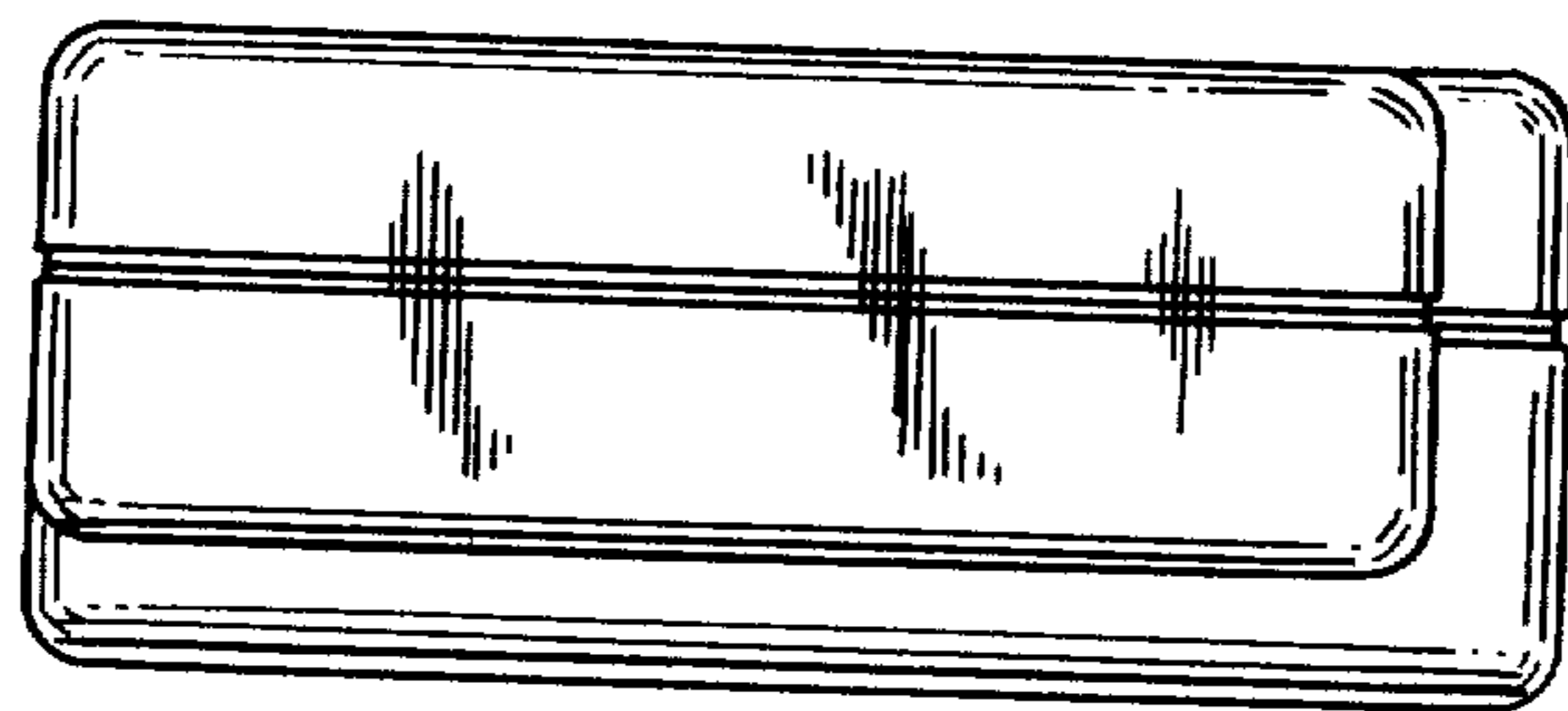
*Fig. 7*



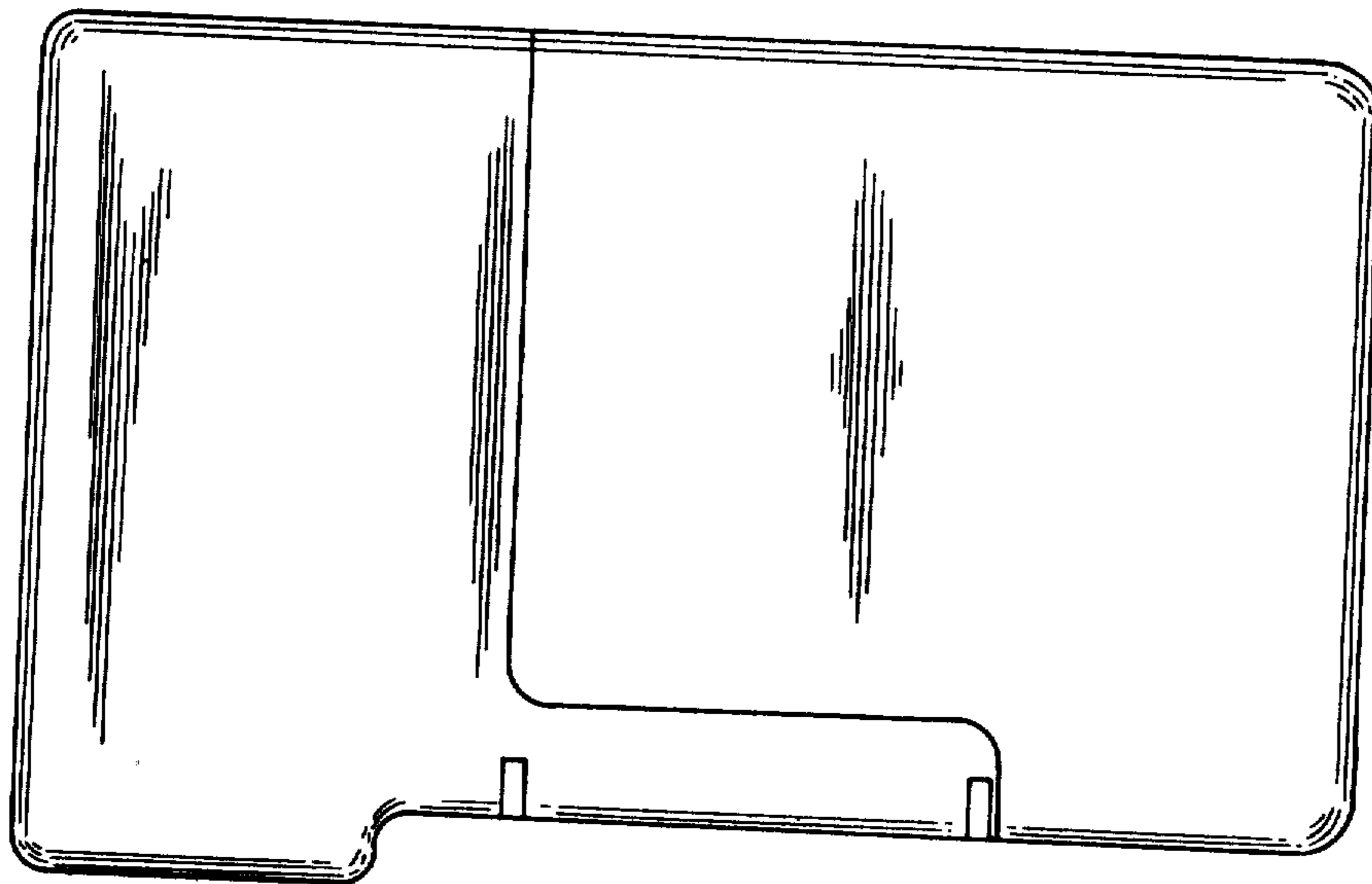
*Fig. 8*



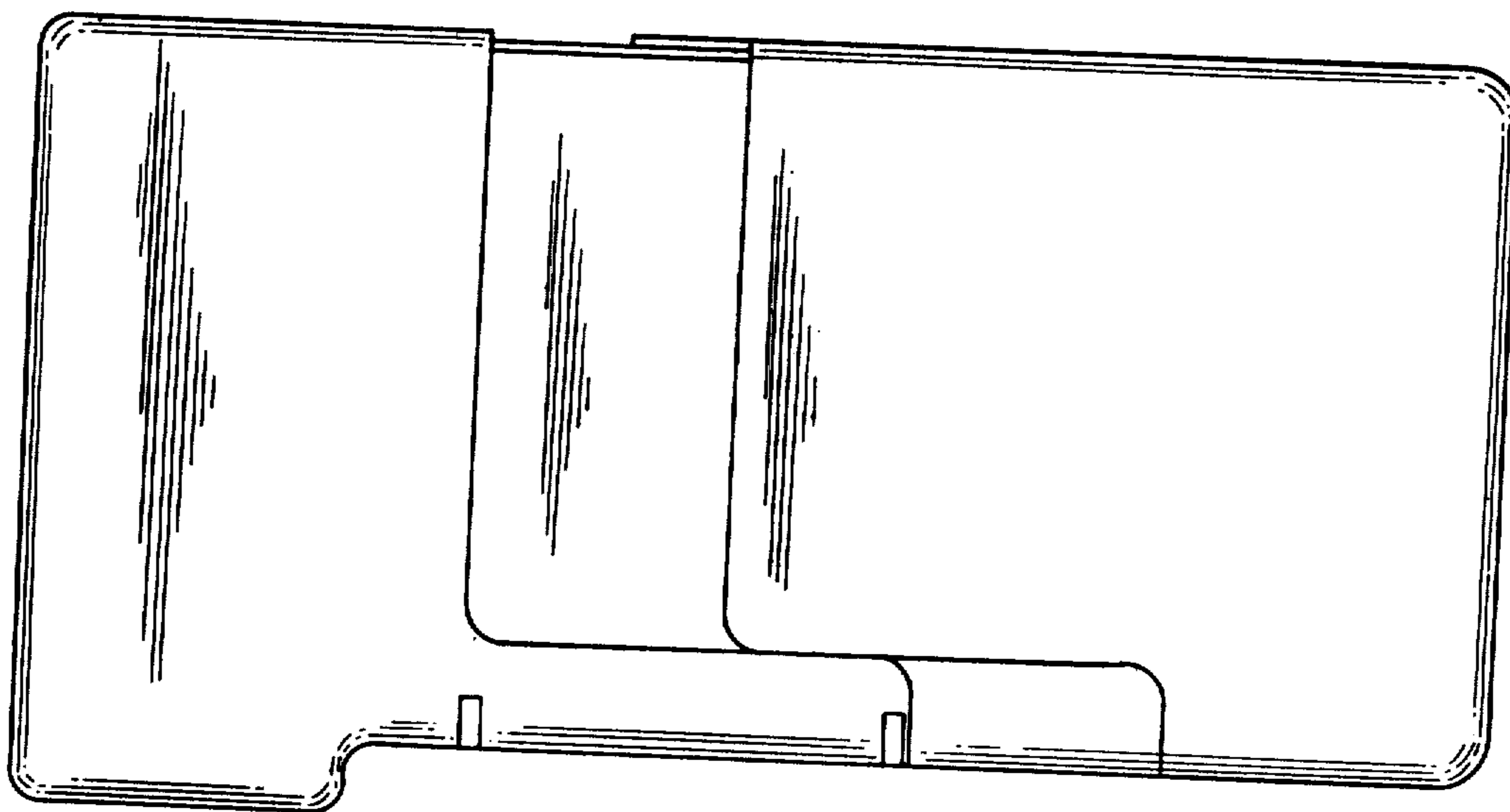
*Fig. 9*



*Fig. 10*



*Fig. 11*



*Fig. 12*