

[54] SEAT OR SIMILAR ARTICLE

3,591,233 7/1971 Turcksin D6/73 X

[75] Inventor: Gae Aulenti, Milan, Italy

[73] Assignee: Knoll International, Inc., New York, N.Y.

[**] Term: Years

[21] Appl. No.: 133,657

[22] Filed: Mar. 24, 1980

OTHER PUBLICATIONS

Brown Jordan Cat., "Bradley VII" GP., p. 24, Chair No. 1310-22.

Harter Corp. Cat., Section 3, Sofa No. HL-3.

Primary Examiner—Bruce W. Dunkins

[57] CLAIM

The ornamental design for seat or similar article, as shown.

Related U.S. Application Data

[62] Division of Ser. No. 827,609, Aug. 25, 1977.

[51] Int. Cl. D6-01

[52] U.S. Cl. D6/73; D6/63

[58] Field of Search D6/47-78

DESCRIPTION

FIG. 1 is a front perspective view of a seat showing my design in the form of an armchair.

FIG. 2 is a side view of the chair of FIG. 1.

FIG. 3 is a rear view of the chair of FIG. 1.

FIG. 4 is a sectional view, to an enlarged scale, taken along the section 4-4 in FIG. 2.

FIG. 5 is a sectional view, to an enlarged scale, taken along the section 5-5 in FIG. 2.

FIG. 6 is a front perspective view of the seat shown in the form of a sofa; and

FIG. 7 is a front elevational view thereof.

[56] References Cited

U.S. PATENT DOCUMENTS

D. 188,046 5/1960 Galloway D6/73

D. 247,335 2/1978 Dranger et al. D6/63

3,310,343 3/1967 Schultz D6/73 X

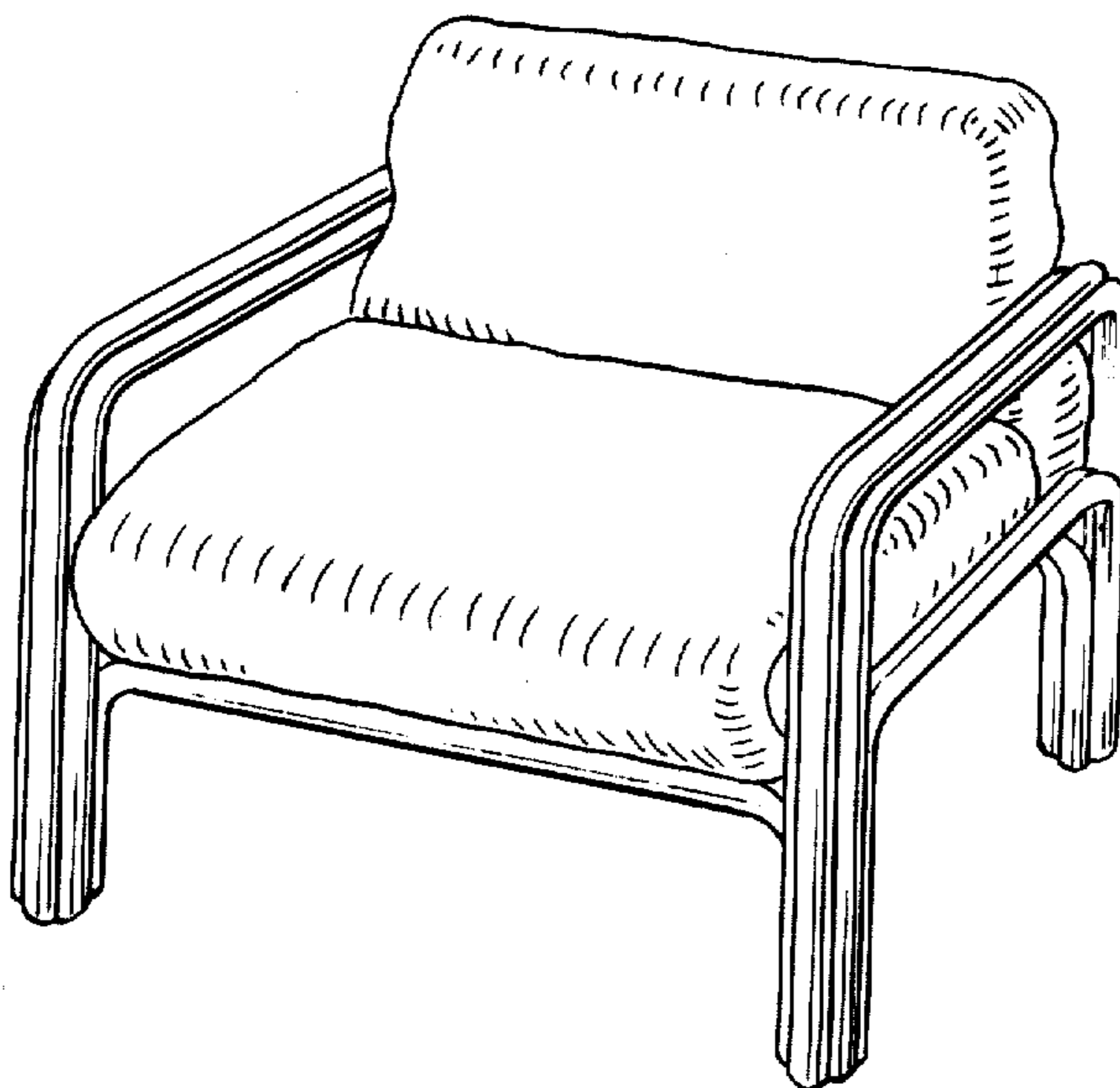

Fig. 1

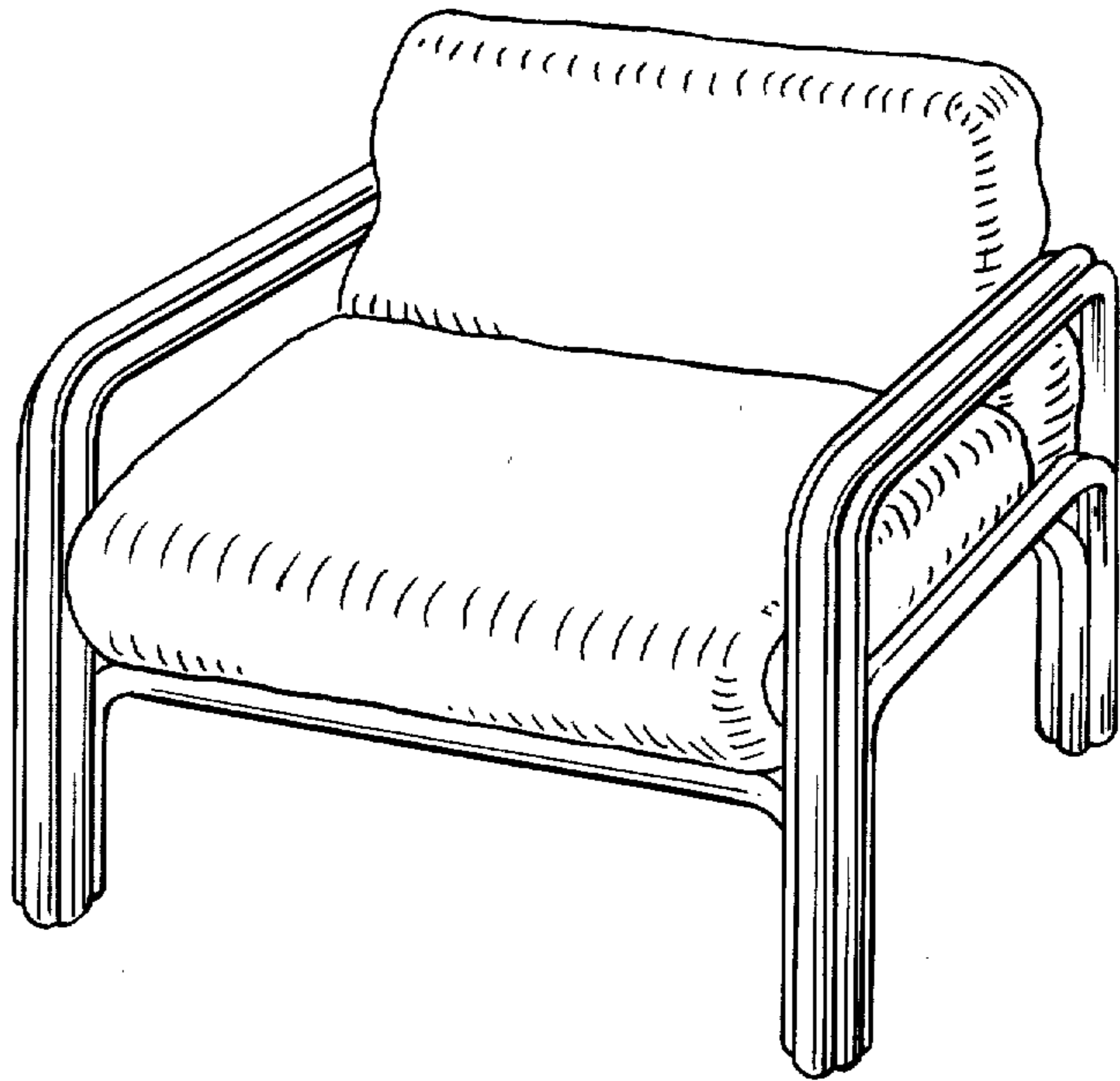

Fig. 2

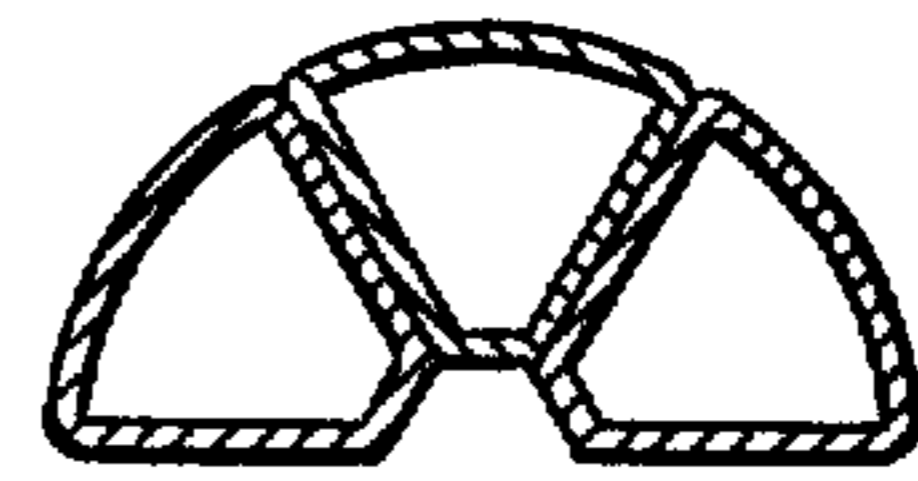
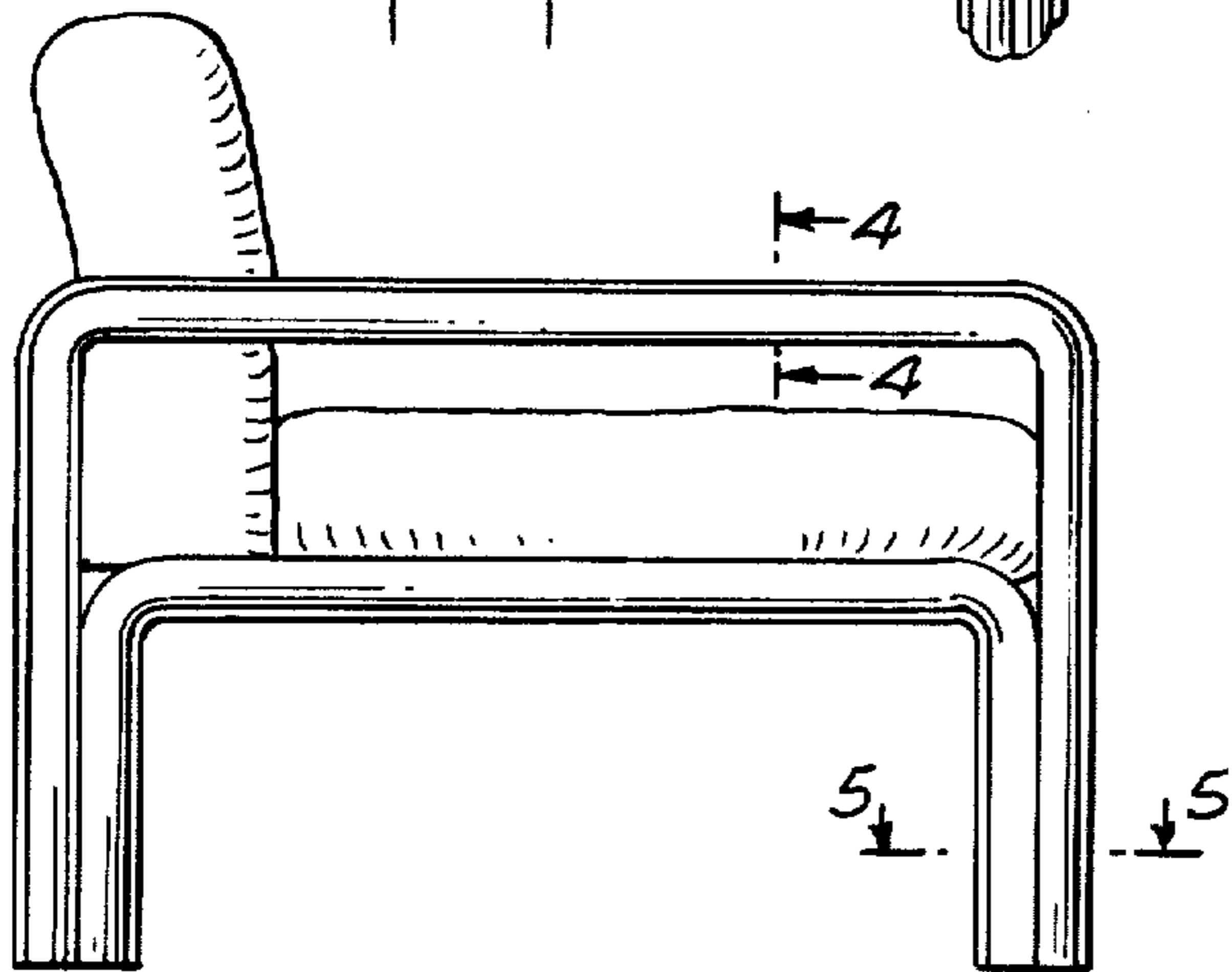

Fig. 4

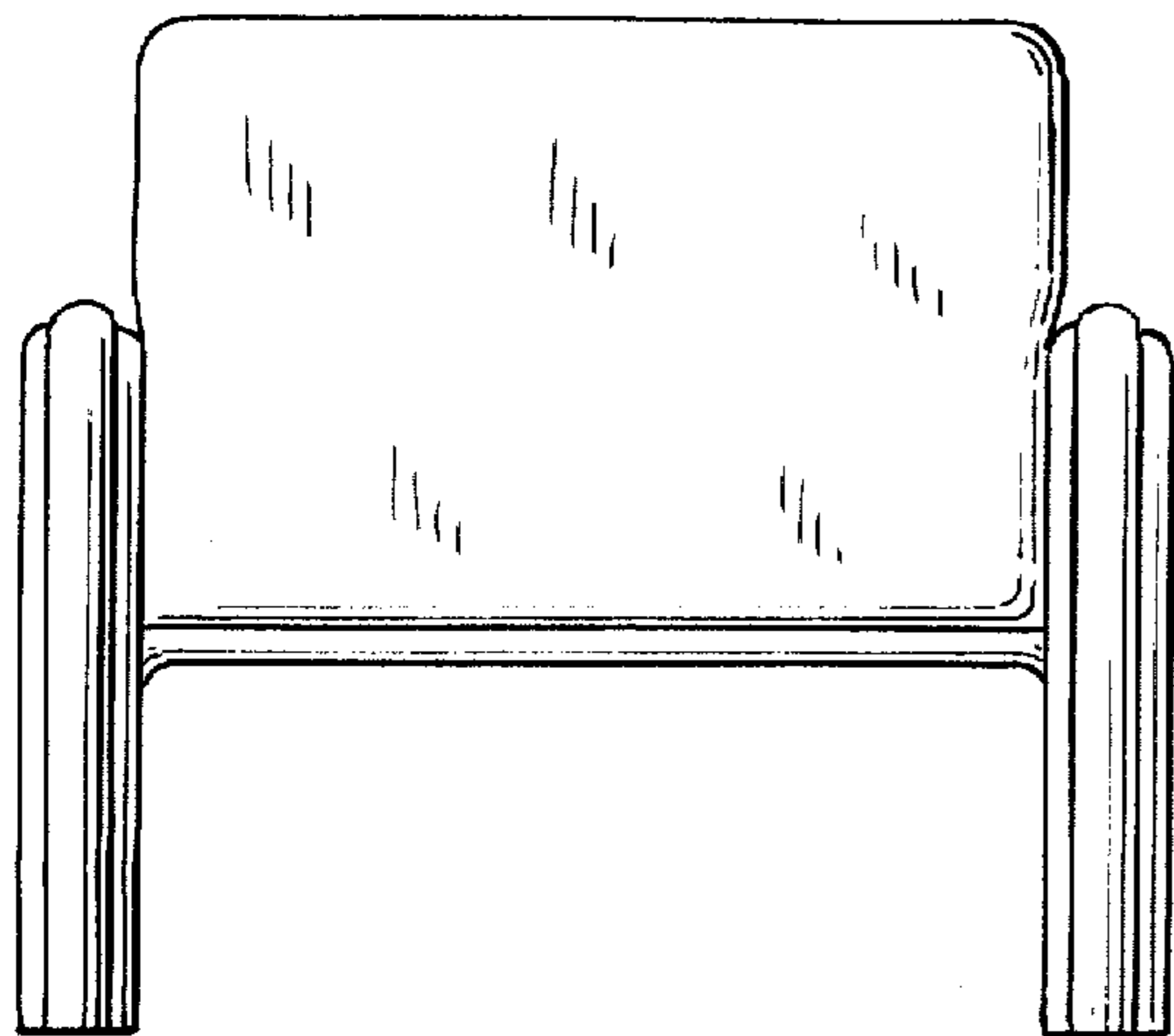

Fig. 3

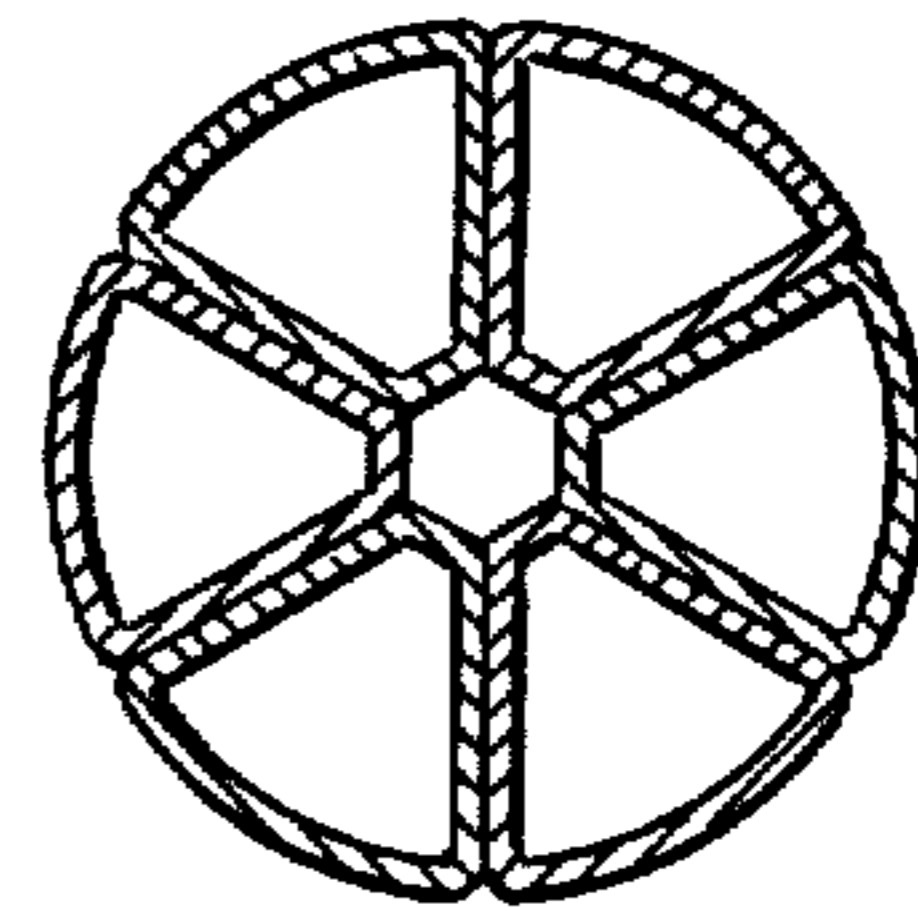

Fig. 5

Fig. 6

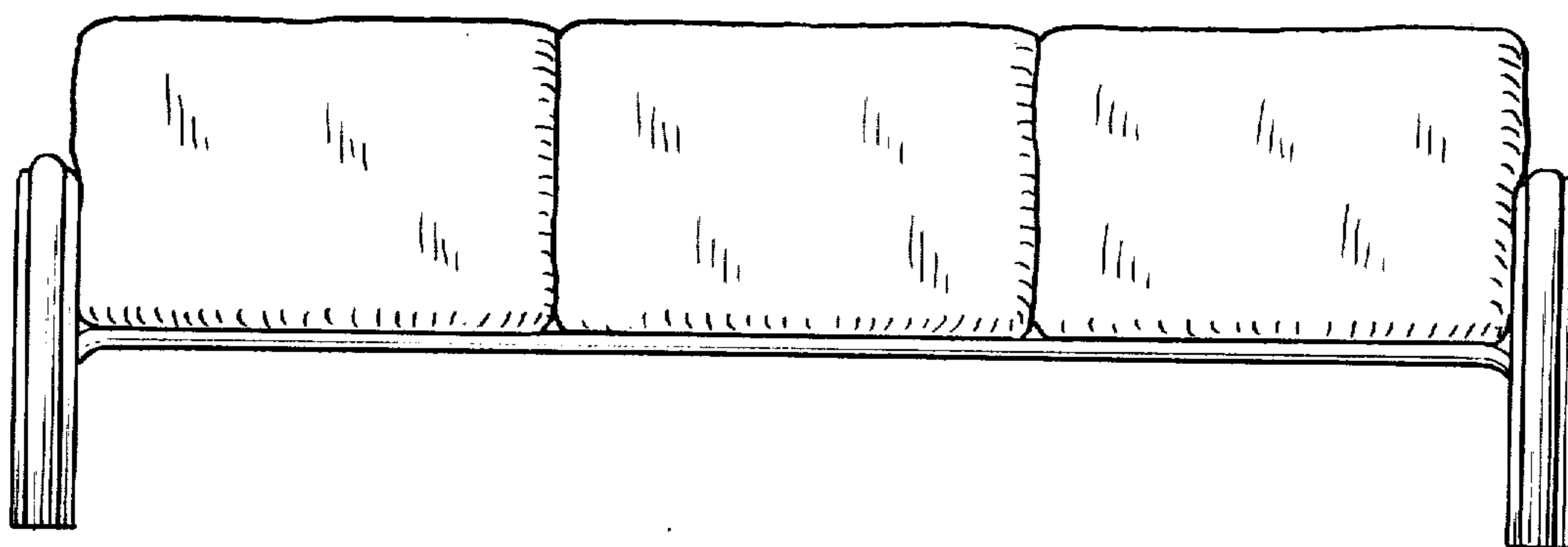
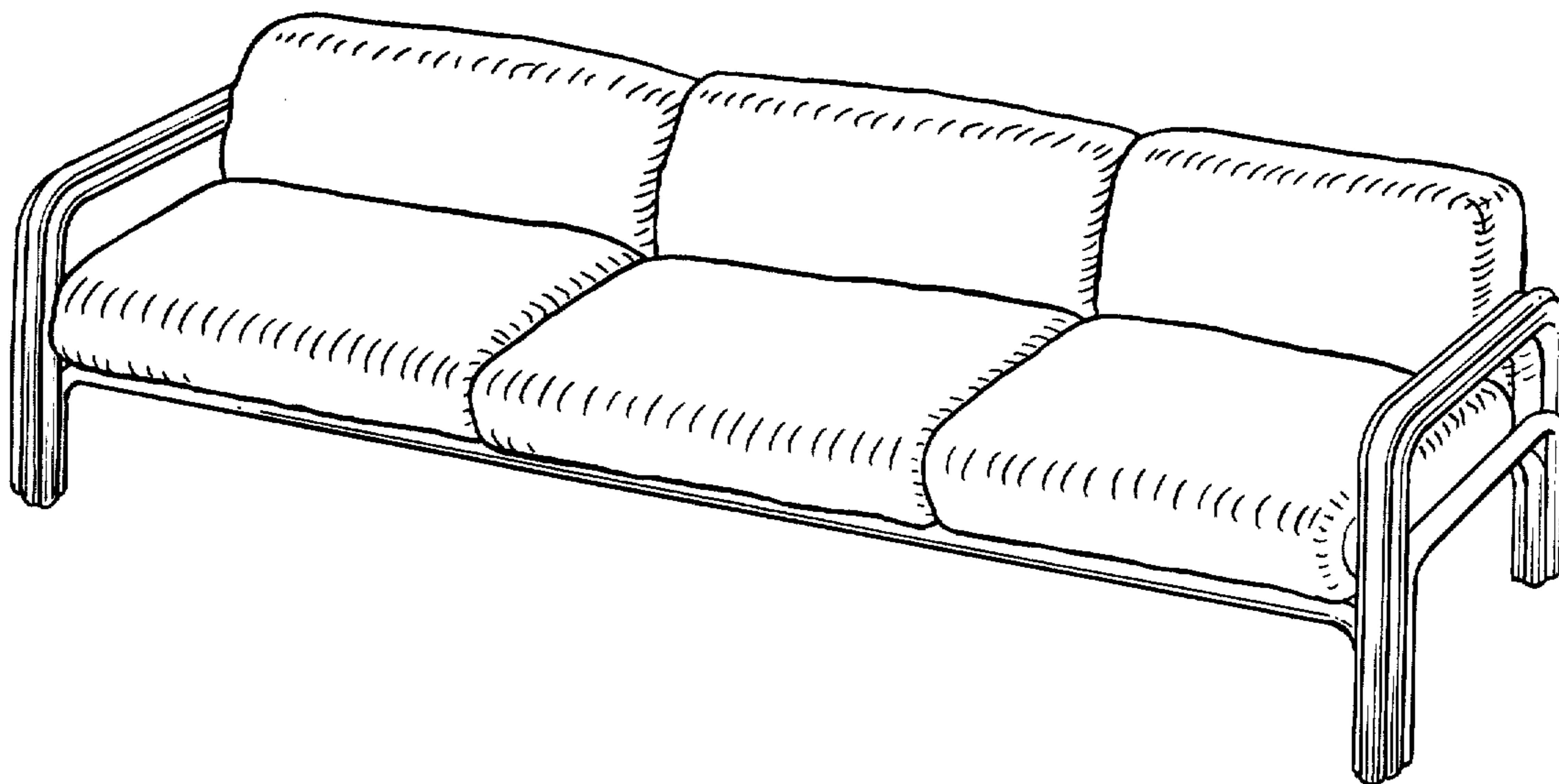

Fig. 7

UNITED STATES PATENT AND TRADEMARK OFFICE
CERTIFICATE OF CORRECTION

PATENT NO. : Des. 260,950

DATED : September 29, 1981

INVENTOR(S) : GAE AULENTI

It is certified that error appears in the above—identified patent and that said Letters Patent is hereby corrected as shown below:

On the Title page after "[**]Term:" should read -- 14years --.

Signed and Sealed this

First Day of December 1981

[SEAL]

Attest:

GERALD J. MOSSINGHOFF

Attesting Officer

Commissioner of Patents and Trademarks