

[54] INHALATOR

[75] Inventor: Ernst Reichl, Munich, Fed. Rep. of Germany

[73] Assignee: Bosch-Siemens Hausgeräte GmbH, Stuttgart, Fed. Rep. of Germany

[\*\*] Term: 14 Years

[21] Appl. No.: 932,757

[22] Filed: Aug. 10, 1978

[30] Foreign Application Priority Data

Mar. 10, 1978 [DE] Fed. Rep. of Germany ..... 4809

[51] Int. Cl. .... D24-02

[52] U.S. Cl. .... D24/62; D23/148

[58] Field of Search ..... 128/200.16, 200.17, 128/200.18, 200.21, 200.23, 200.12, 202.25; D23/146, 148; D24/62; 239/219

[56] References Cited

U.S. PATENT DOCUMENTS

D. 210,435	3/1968	Boldt	.....	D23/148
D. 231,866	6/1974	Blank et al.	.....	D24/62
D. 242,176	11/1976	Levine	.....	D24/62
3,096,762	7/1963	Winchell	.....	128/202.25
3,812,853	5/1974	Crain	.....	128/200.17

Primary Examiner—Bernard Ansher  
Attorney, Agent, or Firm—Herbert L. Lerner

[57] CLAIM

The ornamental design for the inhalator, substantially as shown and described.

DESCRIPTION

FIG. 1 is a front and right side perspective view of the inhalator according to the invention, the left side thereof being identical to the right side; FIG. 2 is a front elevational view of the inhalator according to FIG. 1 rotated counterclockwise through 40°; FIG. 3 is a top plan view of FIG. 2; FIG. 4 is a bottom plan view of FIG. 2; FIG. 5 is a rear elevational view of FIG. 2; and FIG. 6 is an enlarged perspective view of the inhalator in closed position.

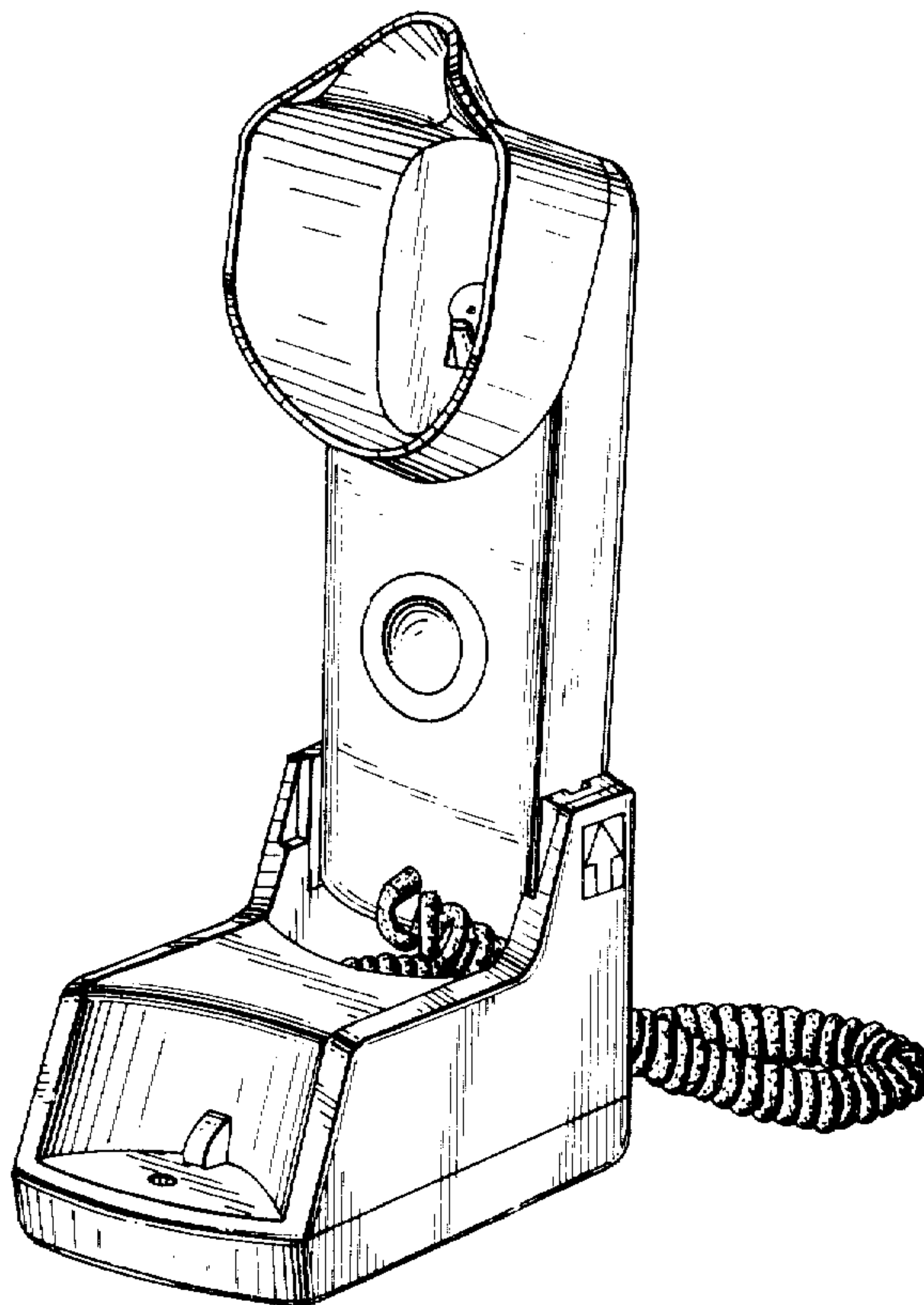

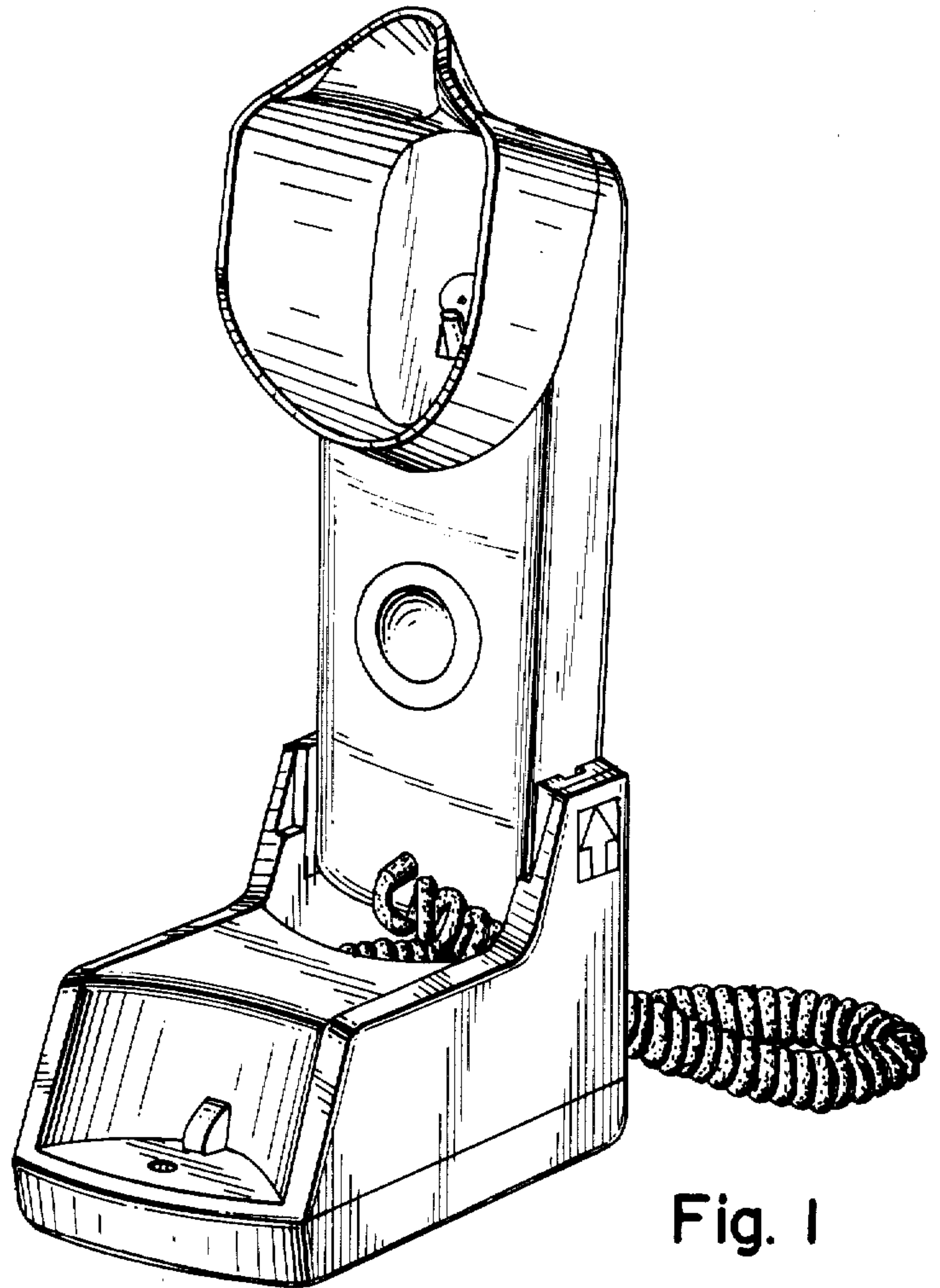

Fig. 1

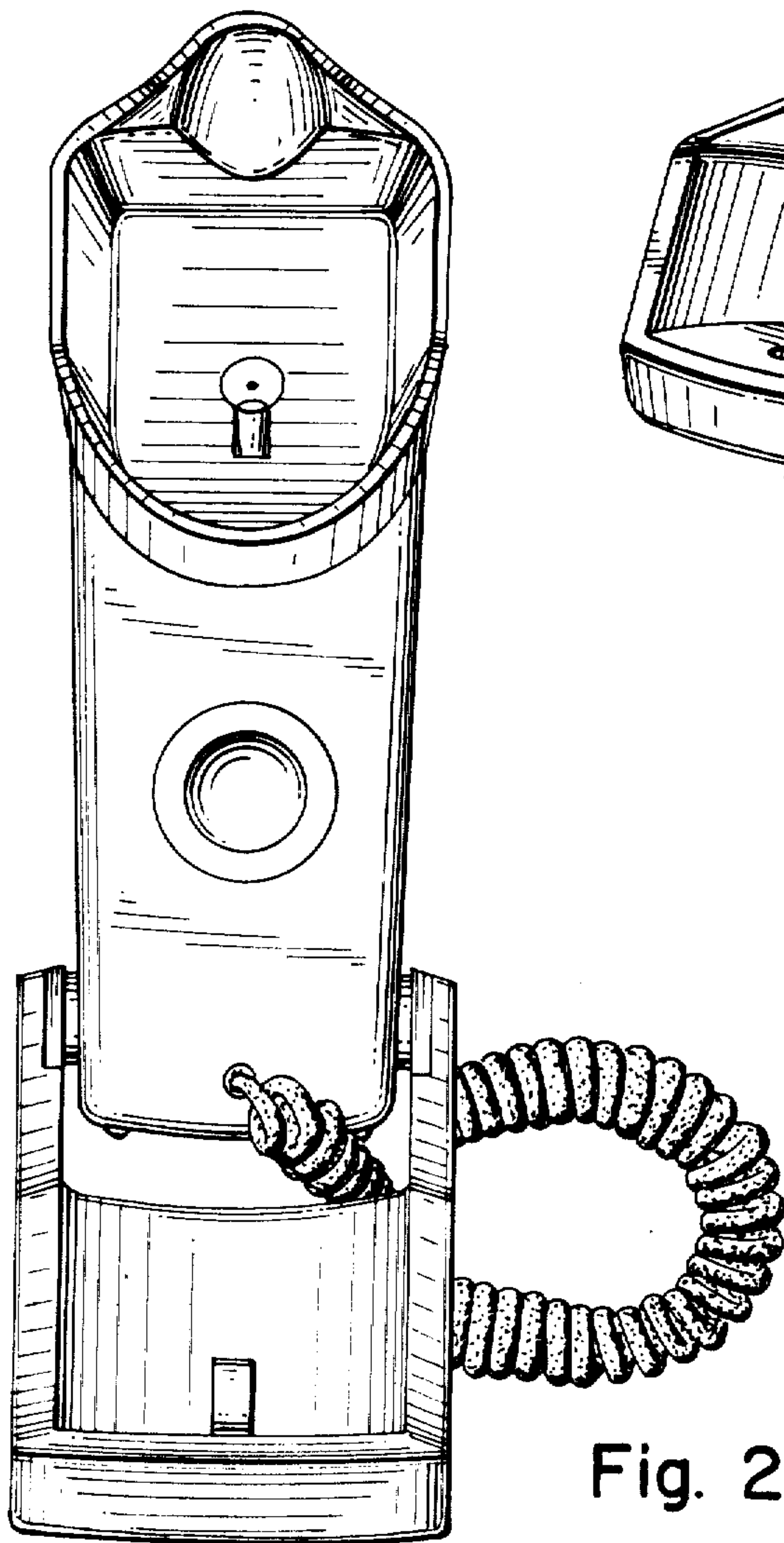

Fig. 2

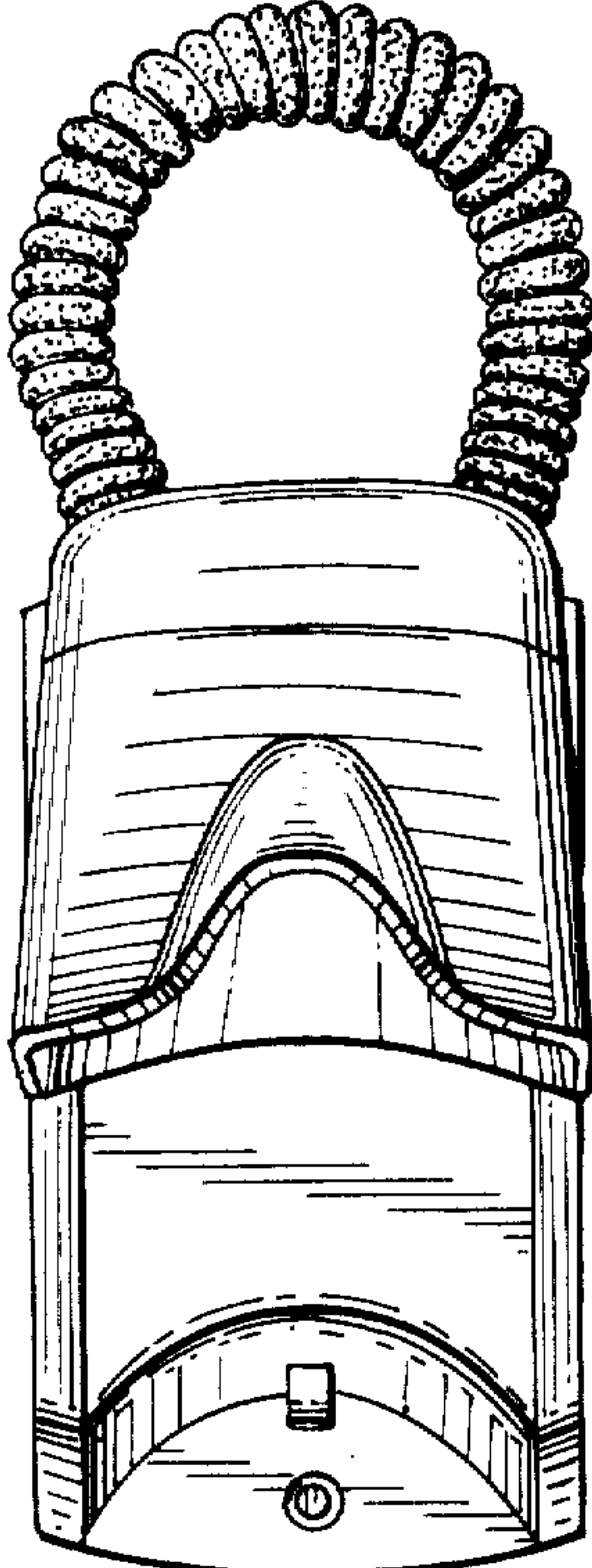

Fig. 3

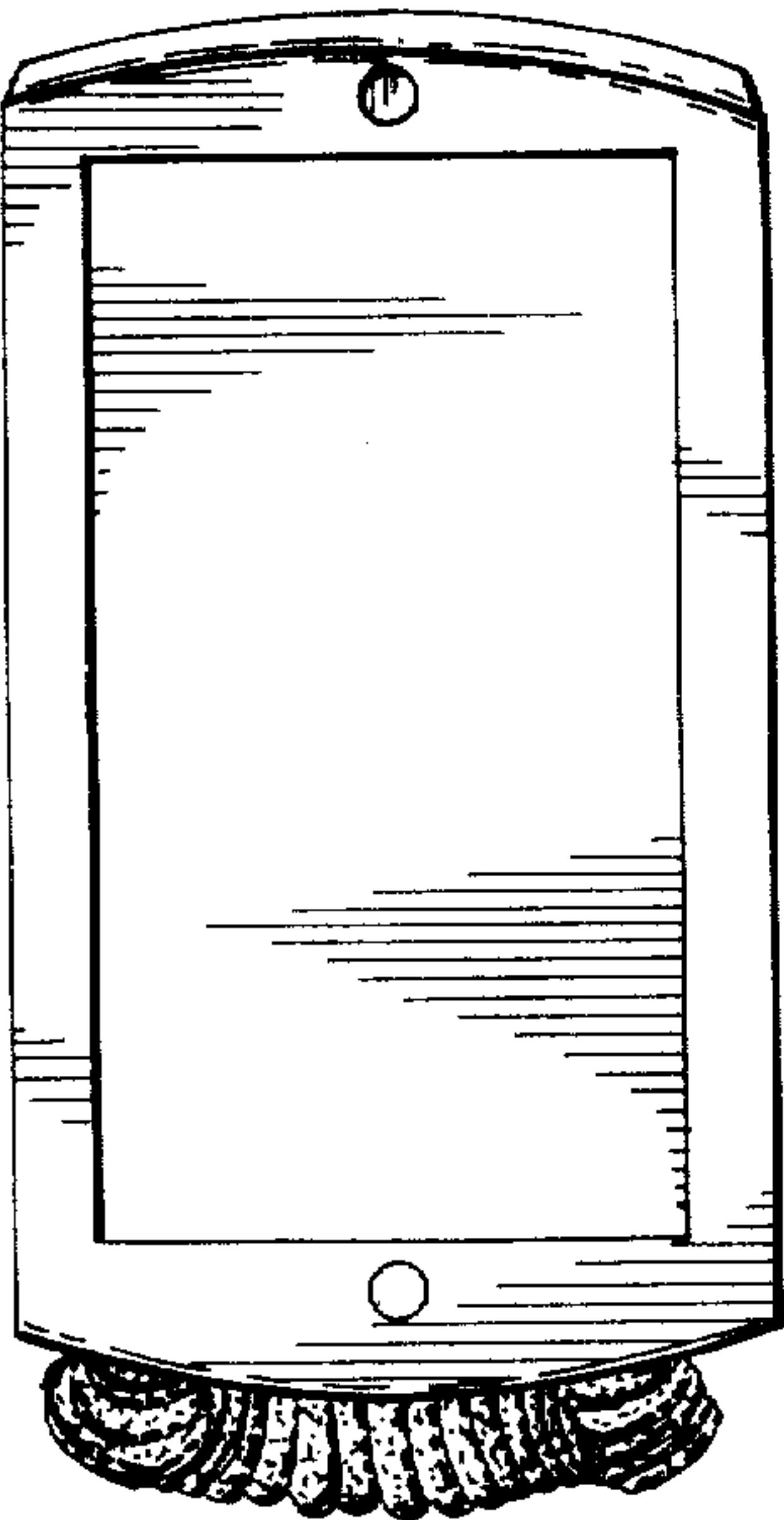

Fig. 4

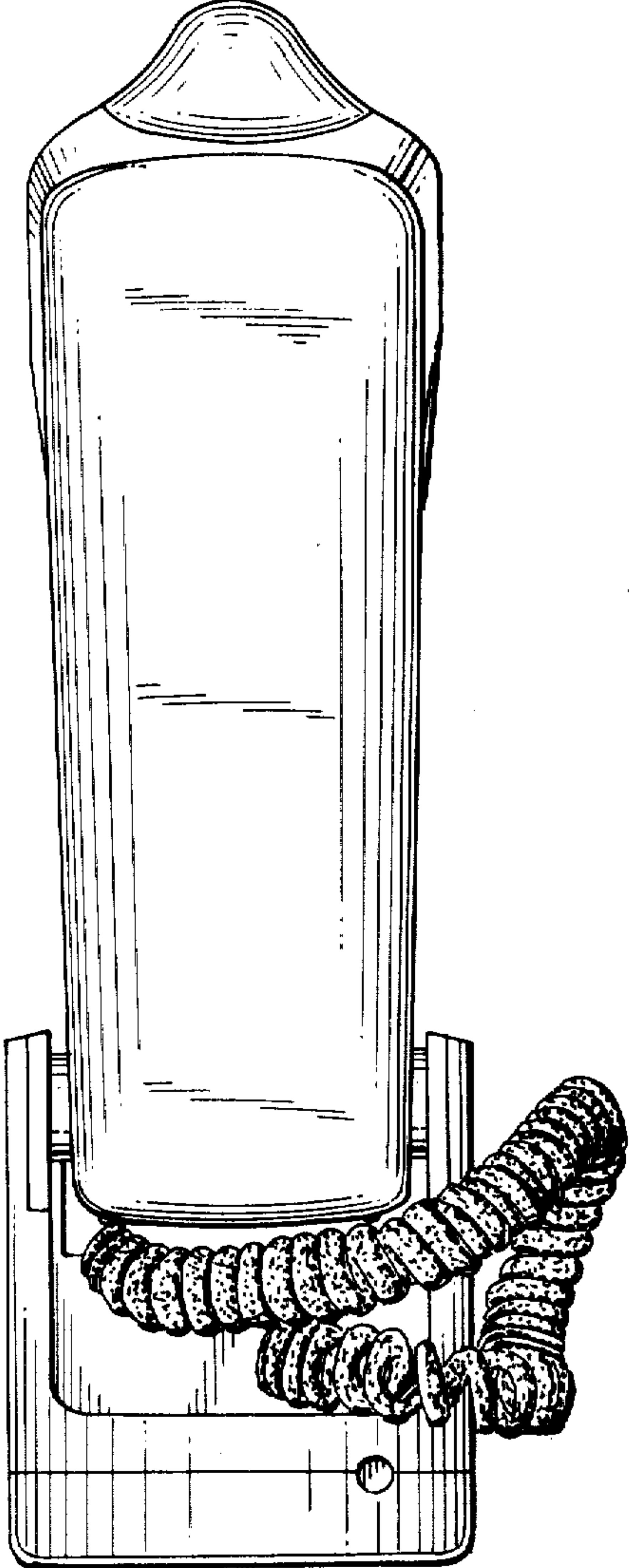

Fig. 5



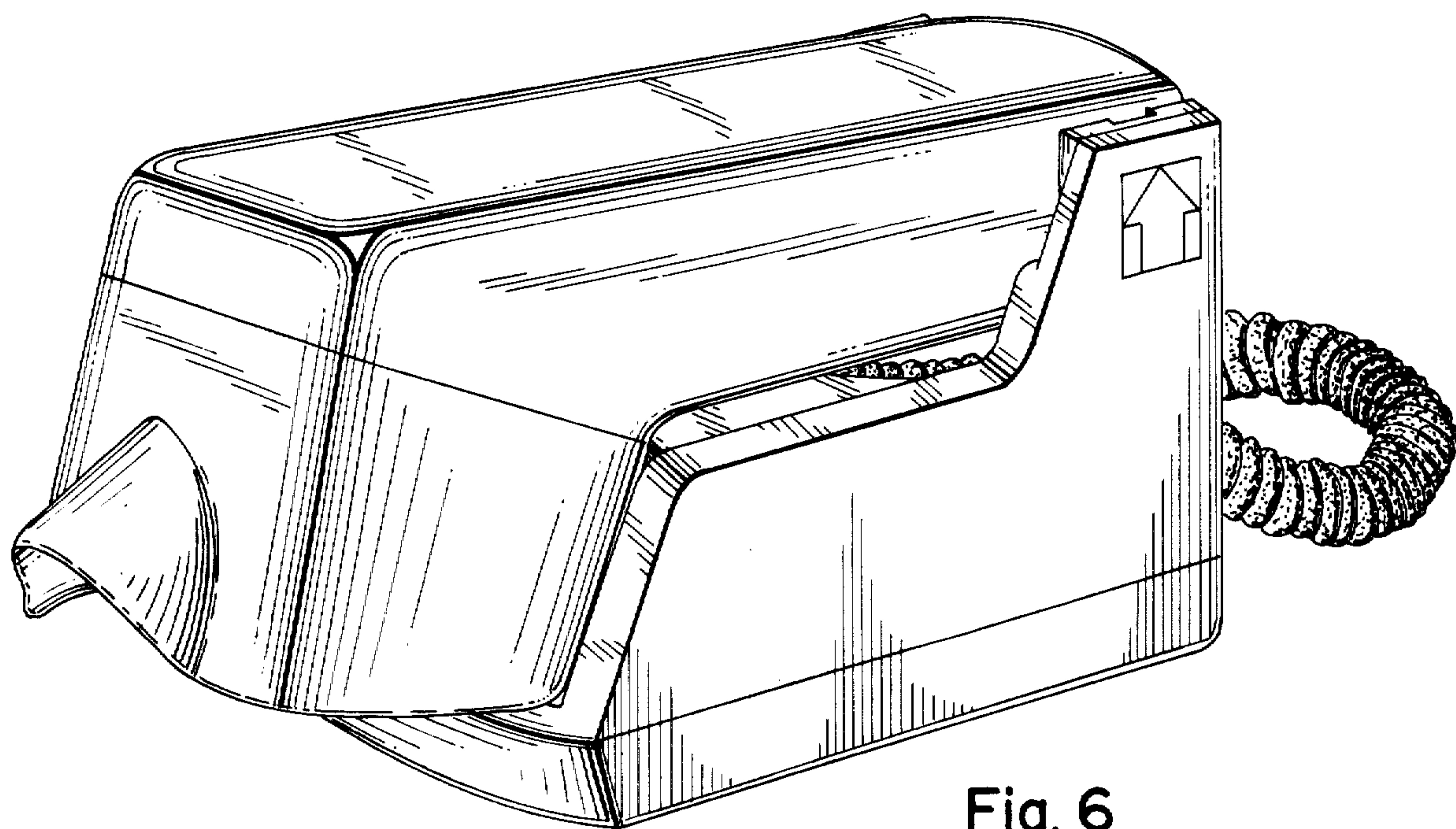

Fig. 6