

- [54] **DESK**
- [75] Inventor: **Warren Platner**, Guilford, Conn.
- [73] Assignee: **Litton Business Systems, Inc.**,
Burlington, Iowa
- [**] Term: **14 Years**
- [21] Appl. No.: **914,285**
- [22] Filed: **Jun. 9, 1978**
- [51] Int. Cl. **D6-04**
- [52] U.S. Cl. **D6/161**
- [58] Field of Search **D6/161-164,**
D6/177-179, 181

References Cited

U.S. PATENT DOCUMENTS

- D. 141,284 5/1945 Daniels D6/161
- D. 149,044 3/1948 Brown et al. D6/161
- D. 153,952 5/1949 Karstadt et al. D6/161
- D. 223,371 4/1972 Allen D6/161

- D. 236,787 9/1975 Stirling D6/161 X
- D. 241,212 8/1976 Hodges et al. D6/161

Primary Examiner—Bruce W. Dunkins
Attorney, Agent, or Firm—Michael H. Wallach; Robert F. Rotella

[57] **CLAIM**

The ornamental design for a desk, as shown and described.

DESCRIPTION

FIG. 1 is a front elevational view of a desk showing my design;
 FIG. 2 is a top plan view;
 FIG. 3 is a rear elevational view;
 FIG. 4 is a right side elevational view;
 FIG. 5 is a bottom plan view; and
 FIG. 6 is an enlarged, detail sectional view taken along line 6—6 of FIG. 4.
 The side of the desk not shown in a mirror image of the side shown in FIG. 4.

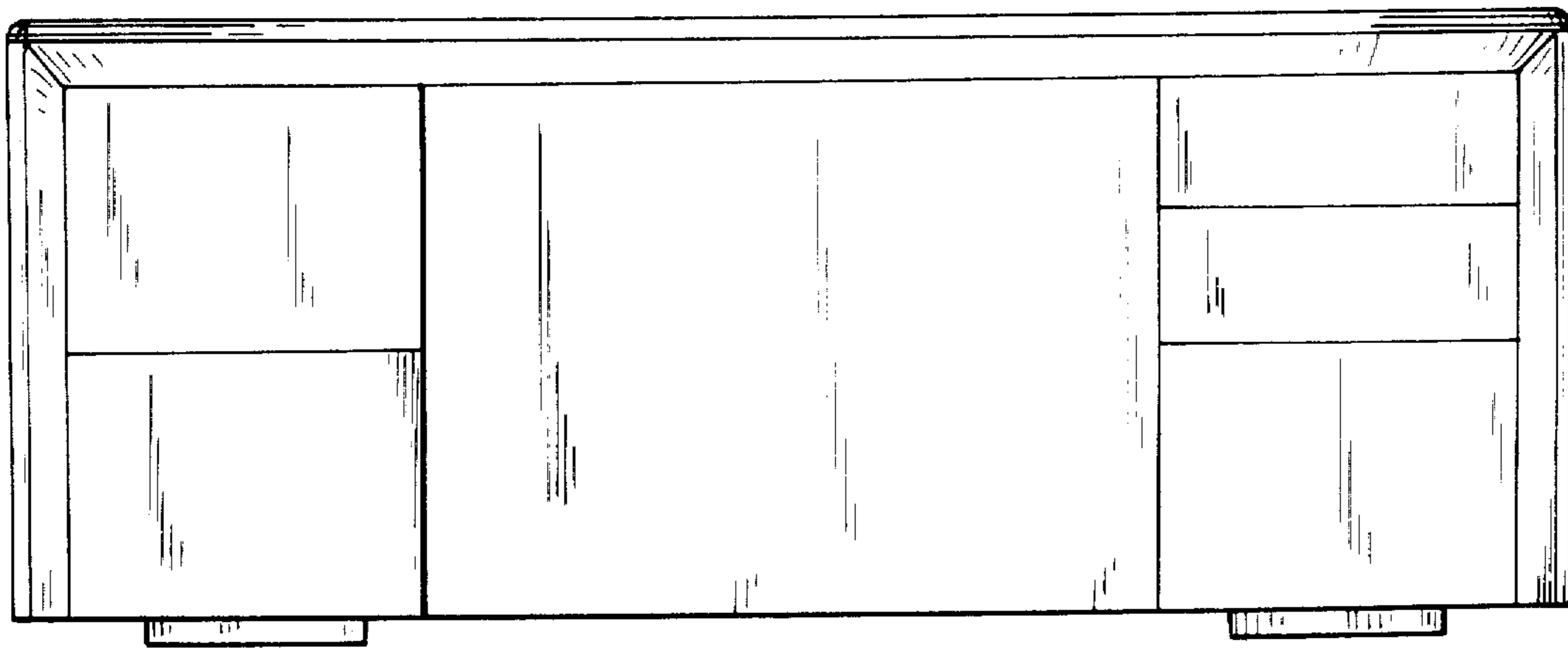

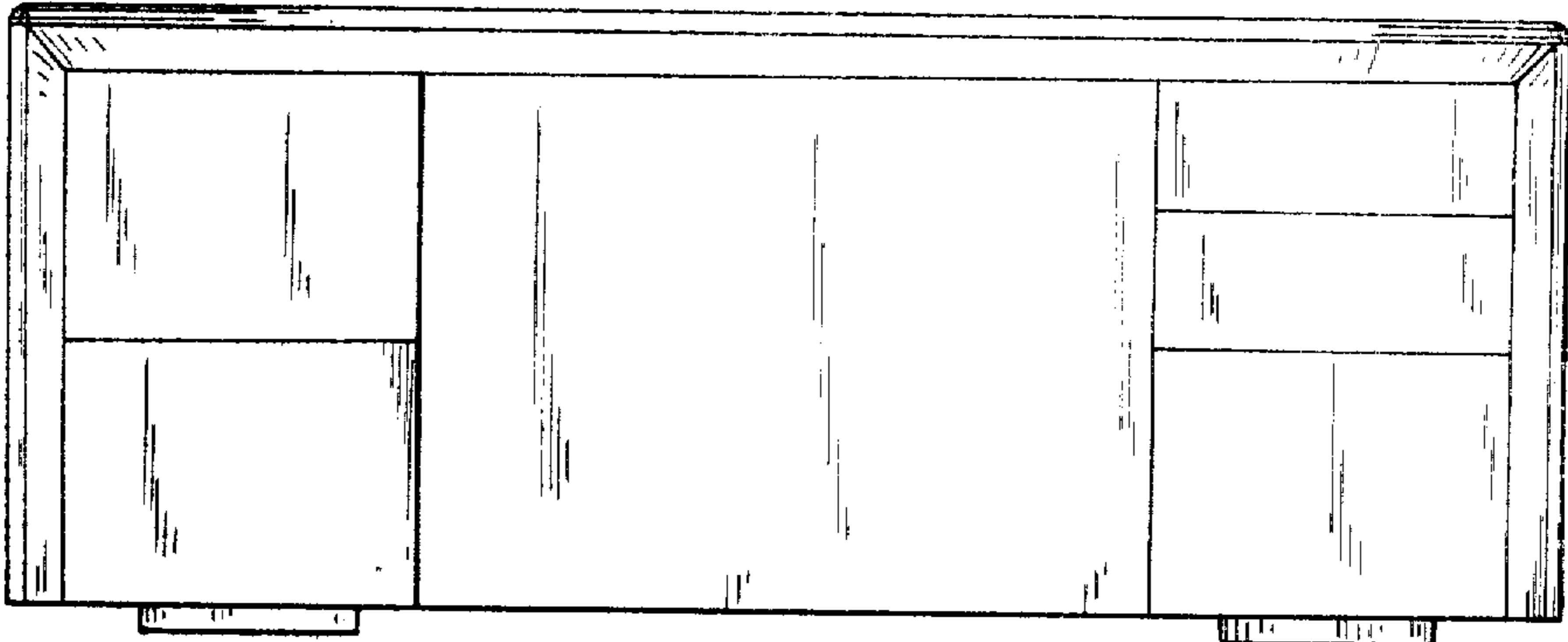

FIG. 1

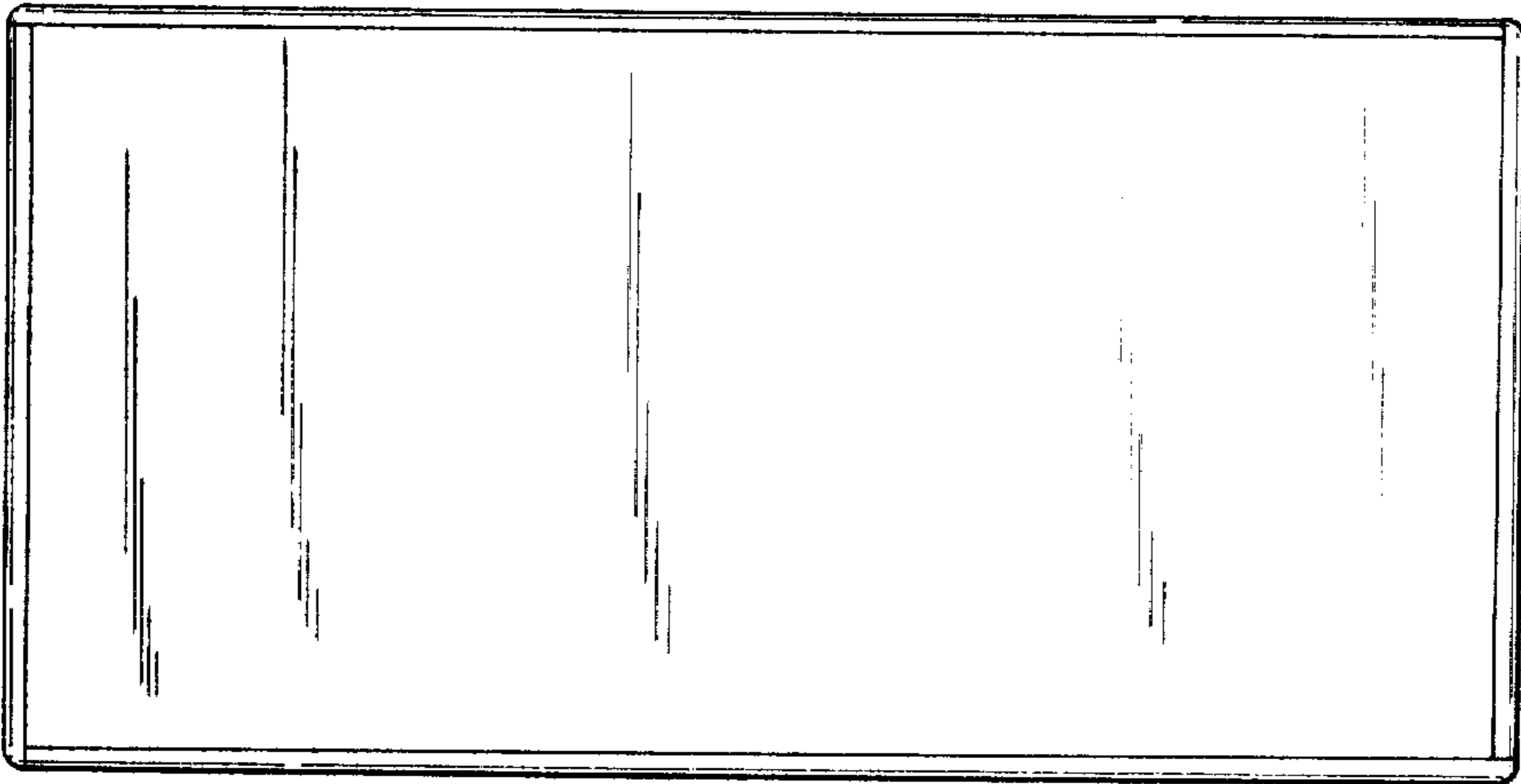

FIG. 2

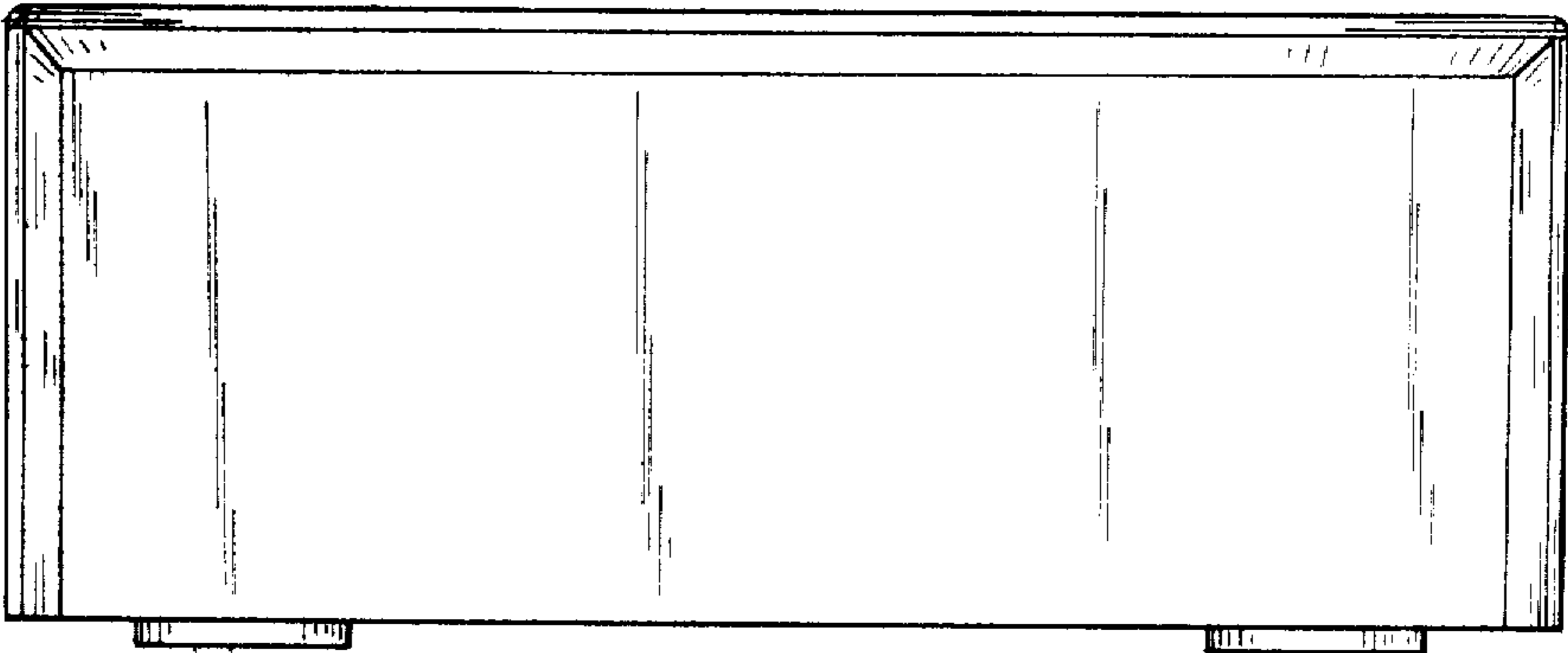

FIG. 3

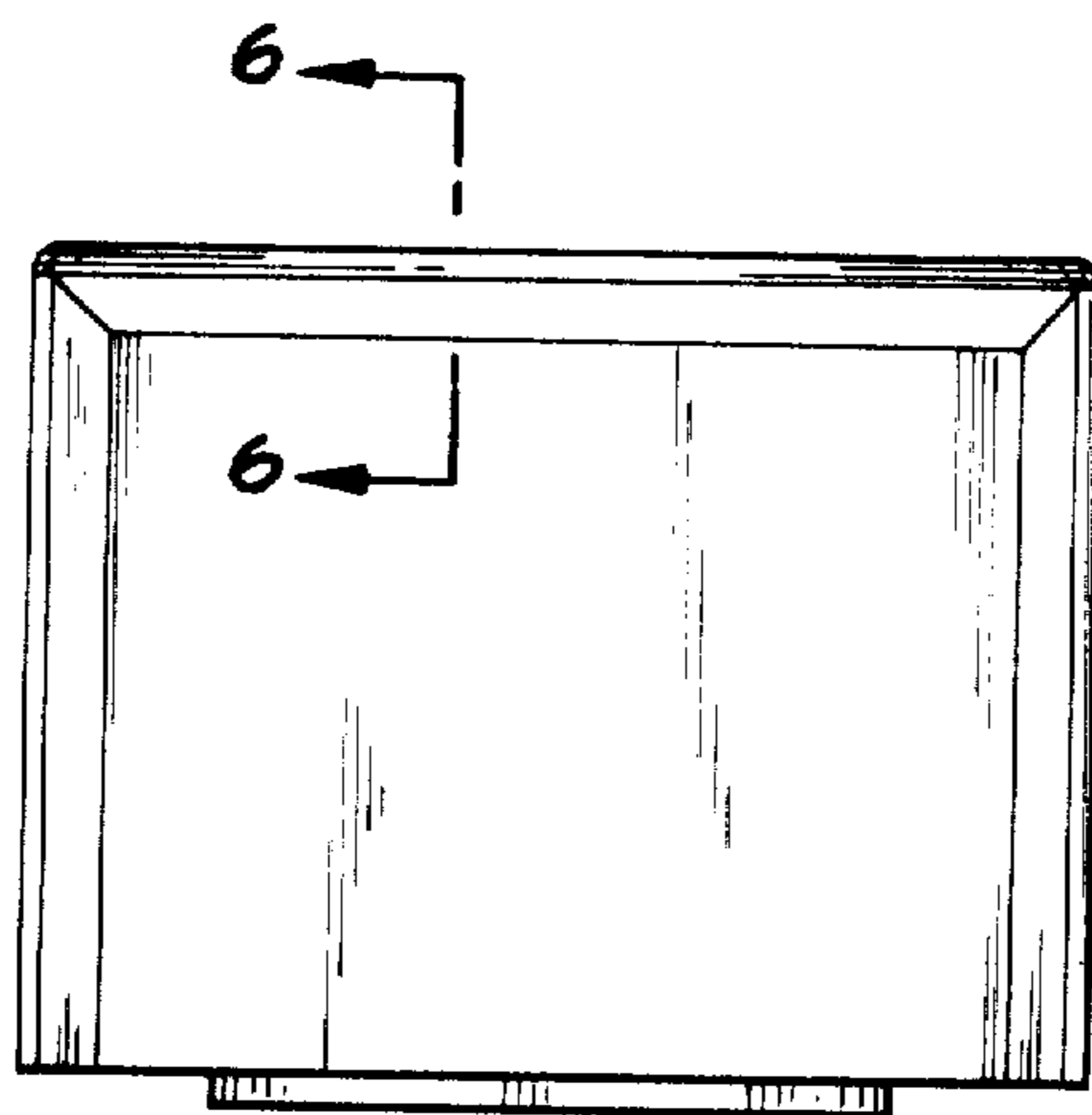

FIG. 4

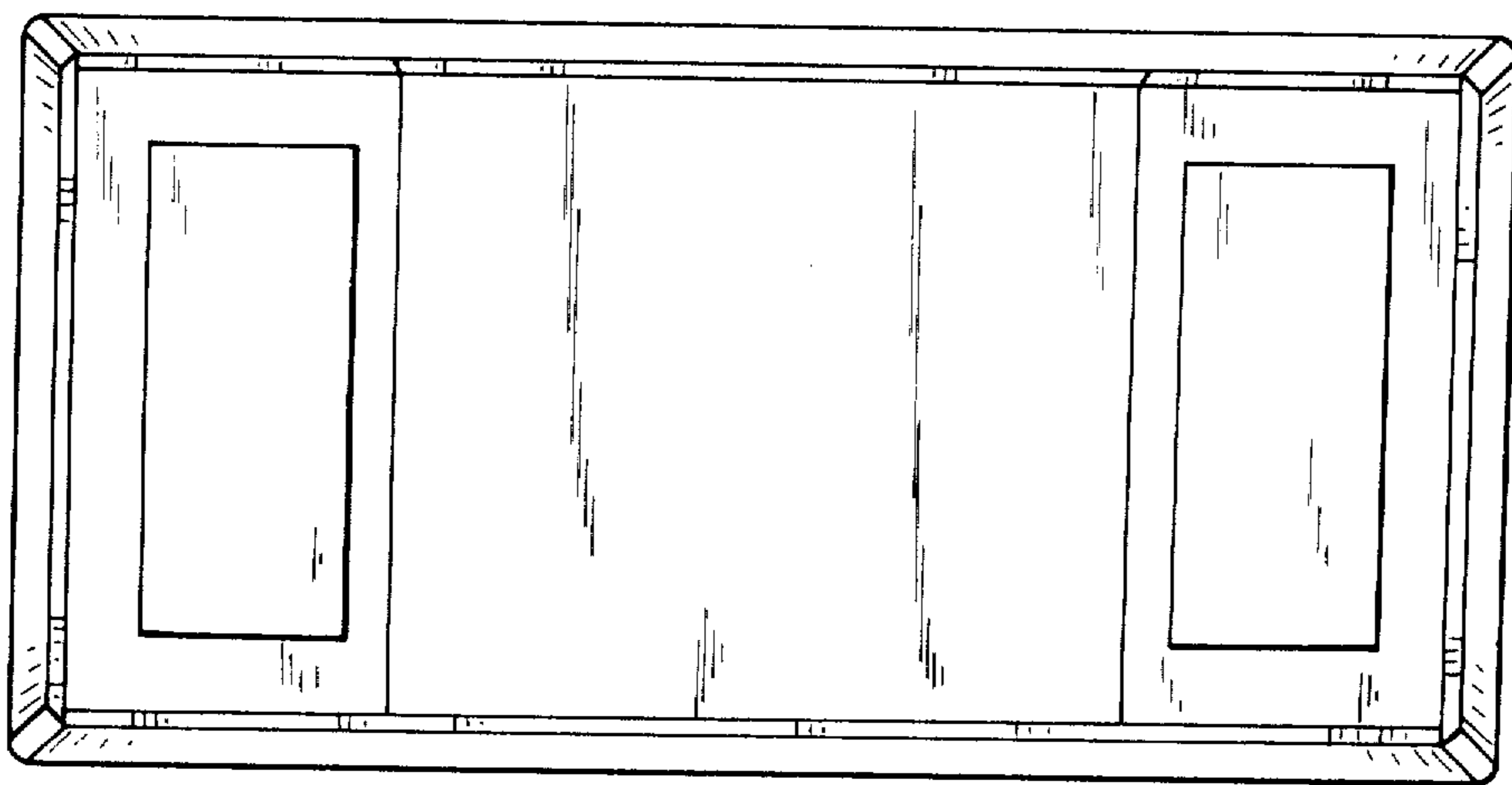

FIG. 5

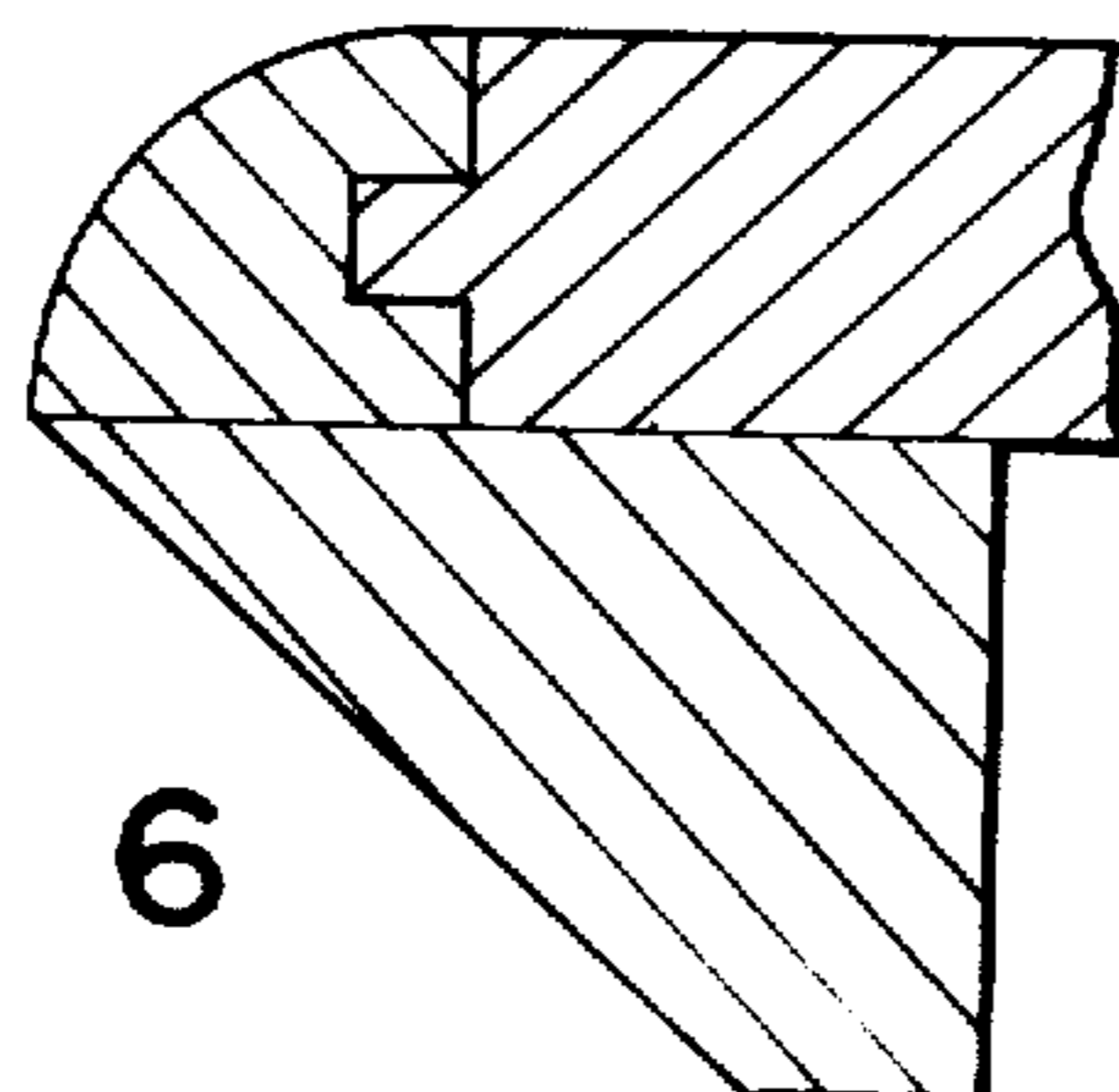

FIG. 6