

[54] STATUE

[76] Inventor: **Richard S. Gorski**, 11312 Grand Oak Dr., B-18 A-10, Grand Blanc, Mich. 48439

[**] Term: **14 Years**

[21] Appl. No.: **893,149**

[22] Filed: **Apr. 3, 1978**

[51] Int. Cl. **D11-02**
[52] U.S. Cl. **D11/157; D7/13**
[58] Field of Search **D11/73, 125, 131, 157; D19/96, 97; 428/7, 15; D7/13; D9/269**

References Cited

U.S. PATENT DOCUMENTS

D. 149,996 6/1948 Bachinsky et al. D9/269

FOREIGN PATENT DOCUMENTS

555192 6/1923 France D7/13

OTHER PUBLICATIONS

Domus, 10/1960, p. 29, Glass at center left.

Primary Examiner—Louis S. Zarfes

Attorney, Agent, or Firm—Basile, Weintraub & Hanlon

[57] **CLAIM**

The ornamental design for a statue, as shown and described.

DESCRIPTION

FIG. 1 is a first side elevational view of a statue showing my new design;
FIG. 2 is a second side elevational view as seen from the side opposite that of FIG. 1;
FIG. 3 is a first end elevational view hereof;
FIG. 4 is a second end elevational view hereof, as seen from the end opposite that of FIG. 3;
FIG. 5 is a top plan view hereof, and;
FIG. 6 is a bottom plan view hereof.

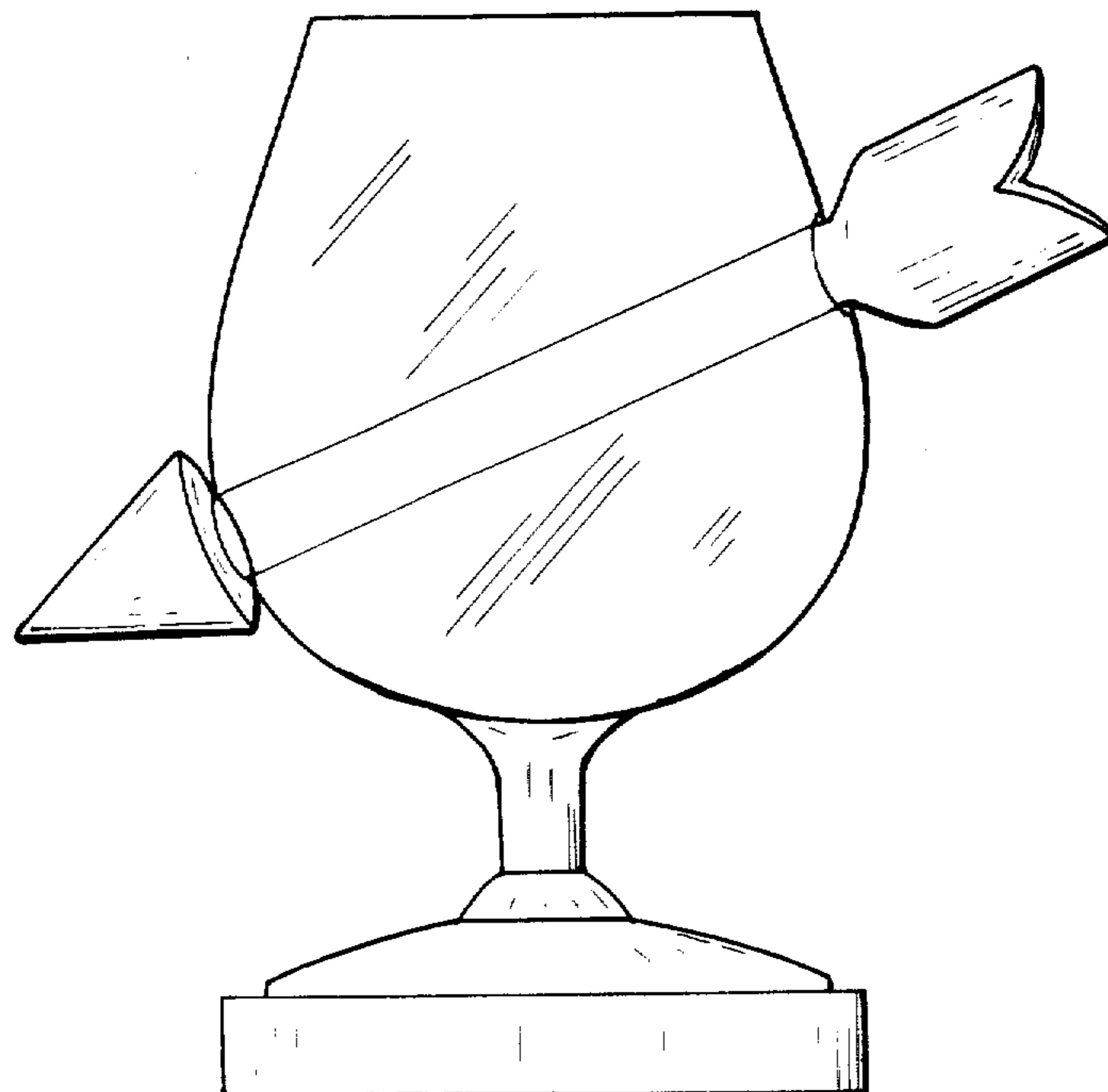

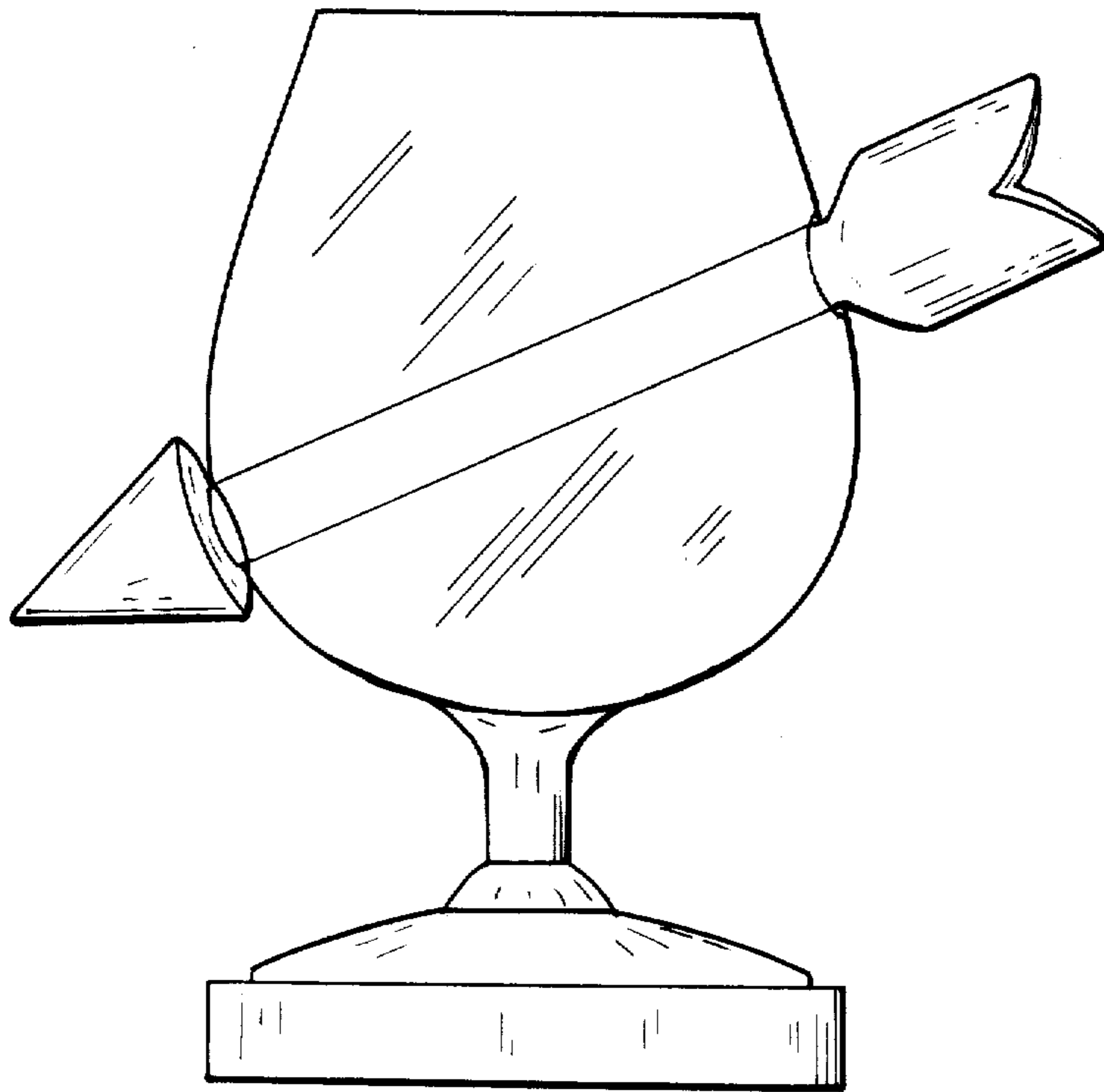

FIG-1

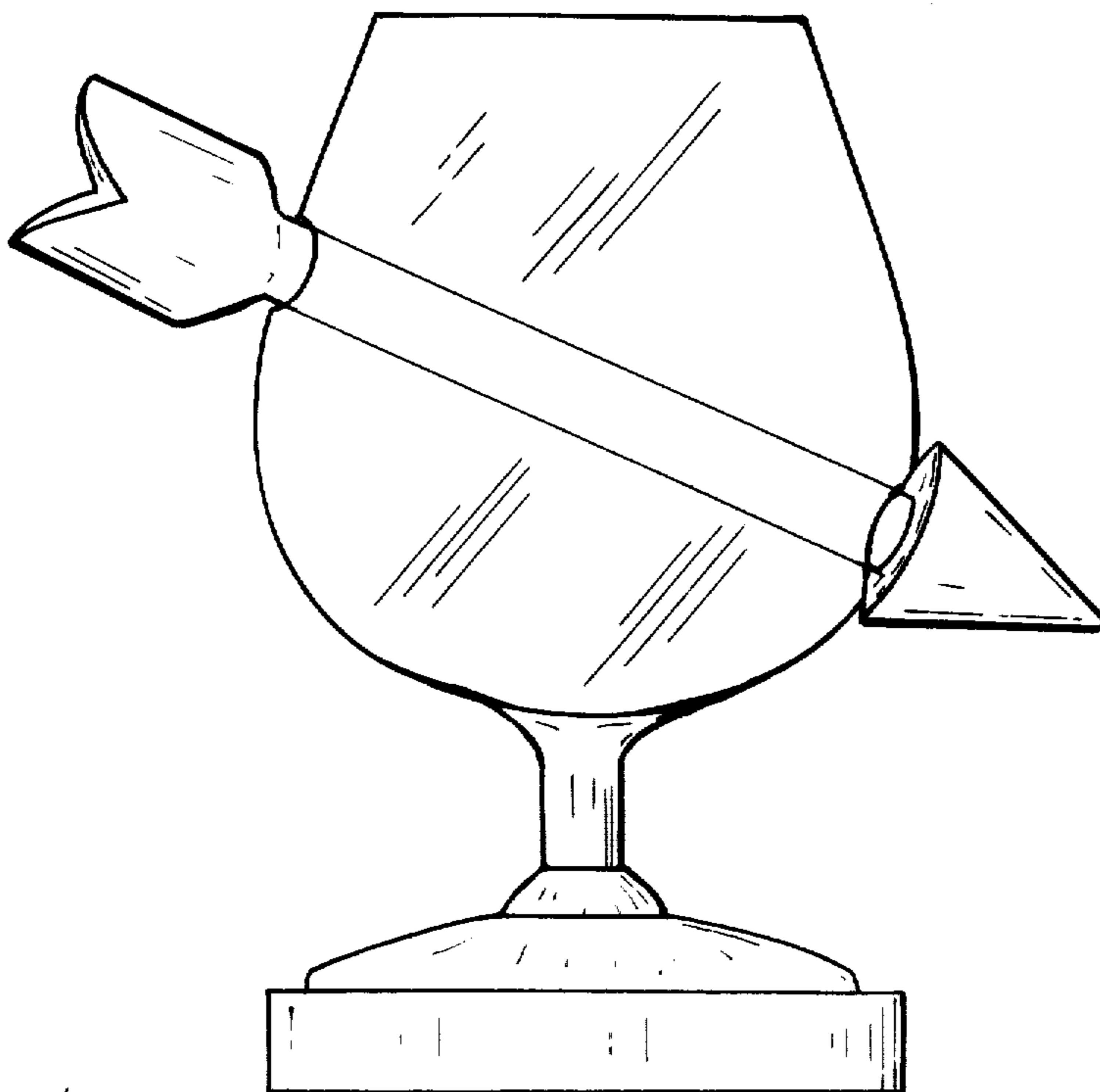

FIG-2

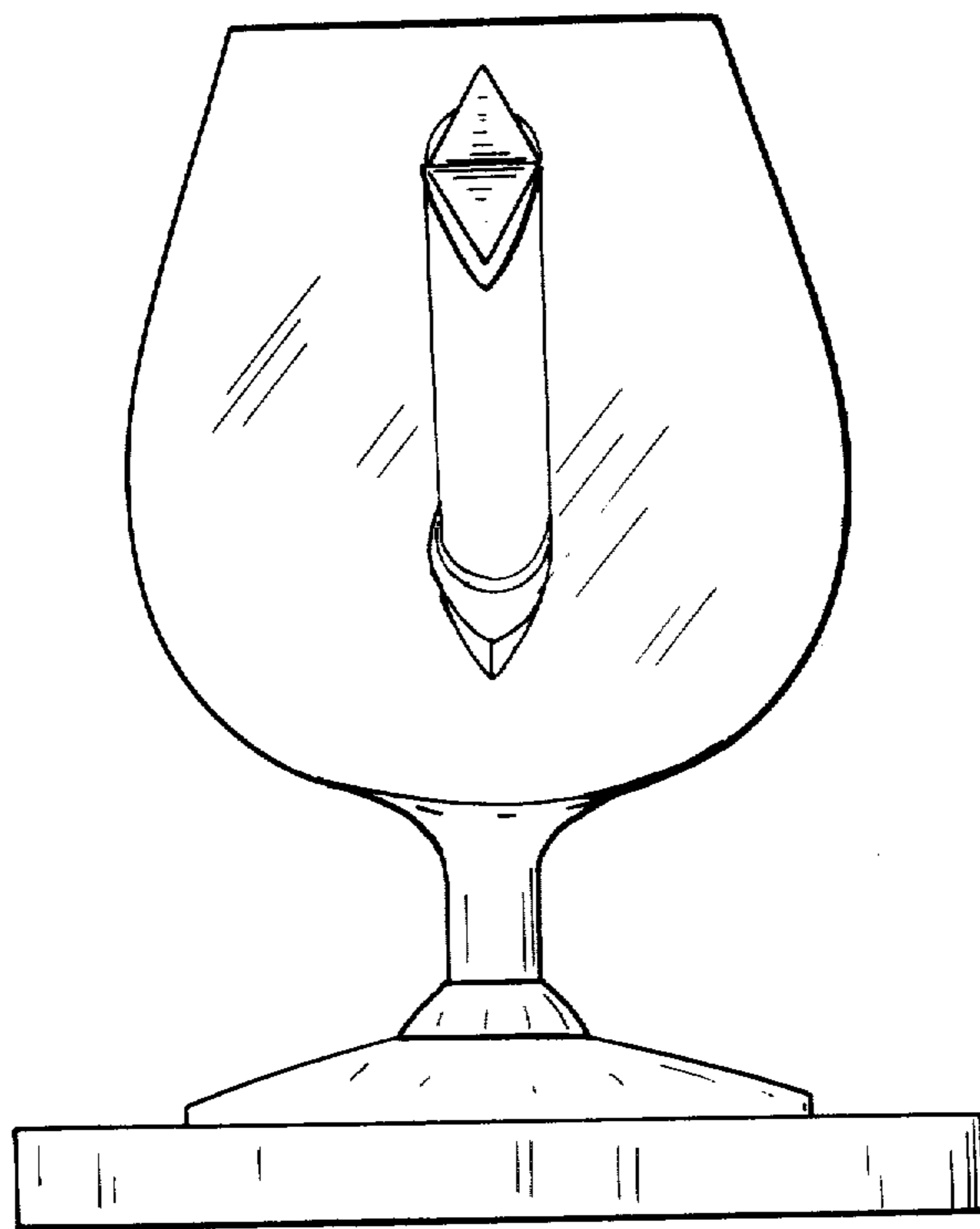

FIG - 3

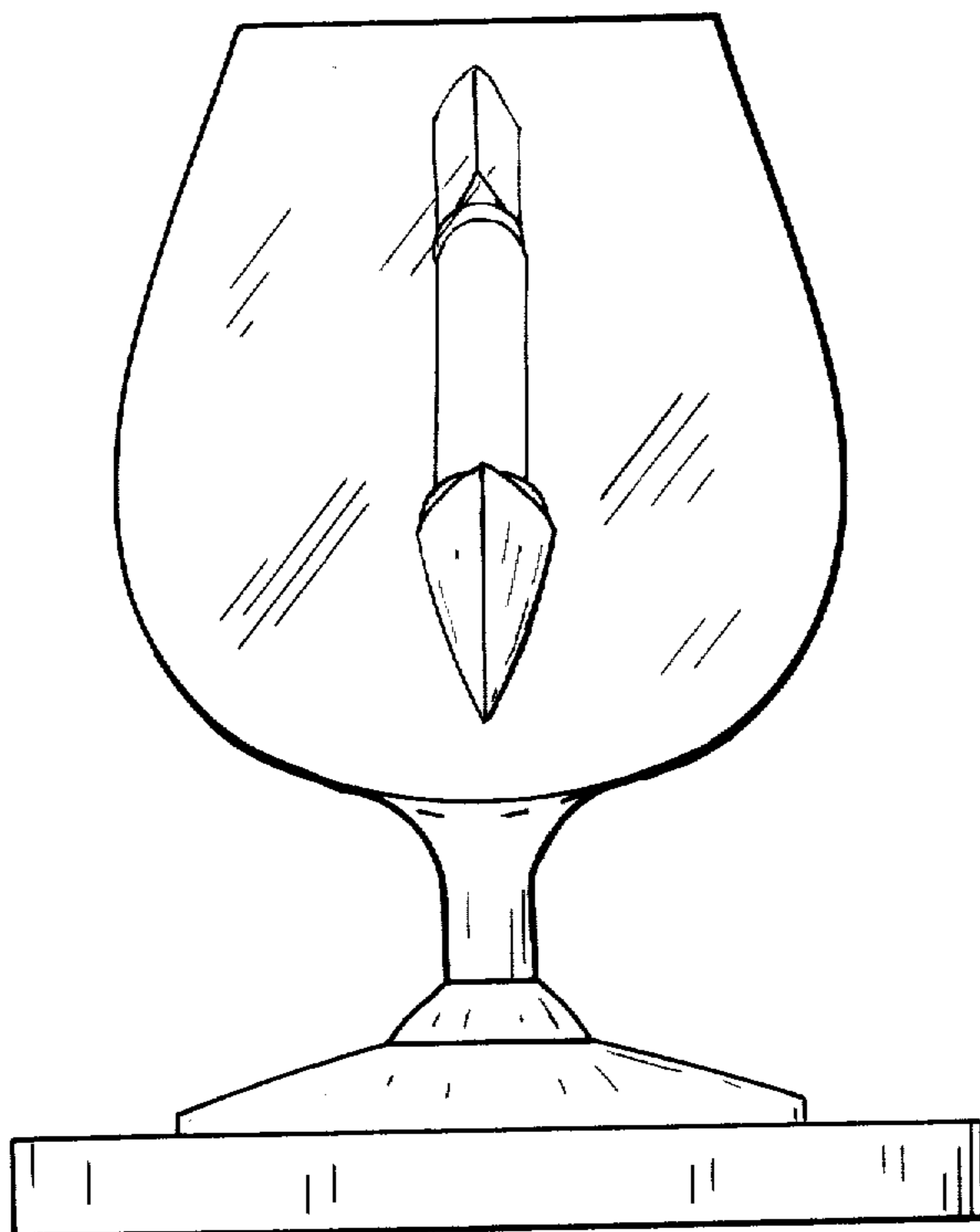

FIG - 4

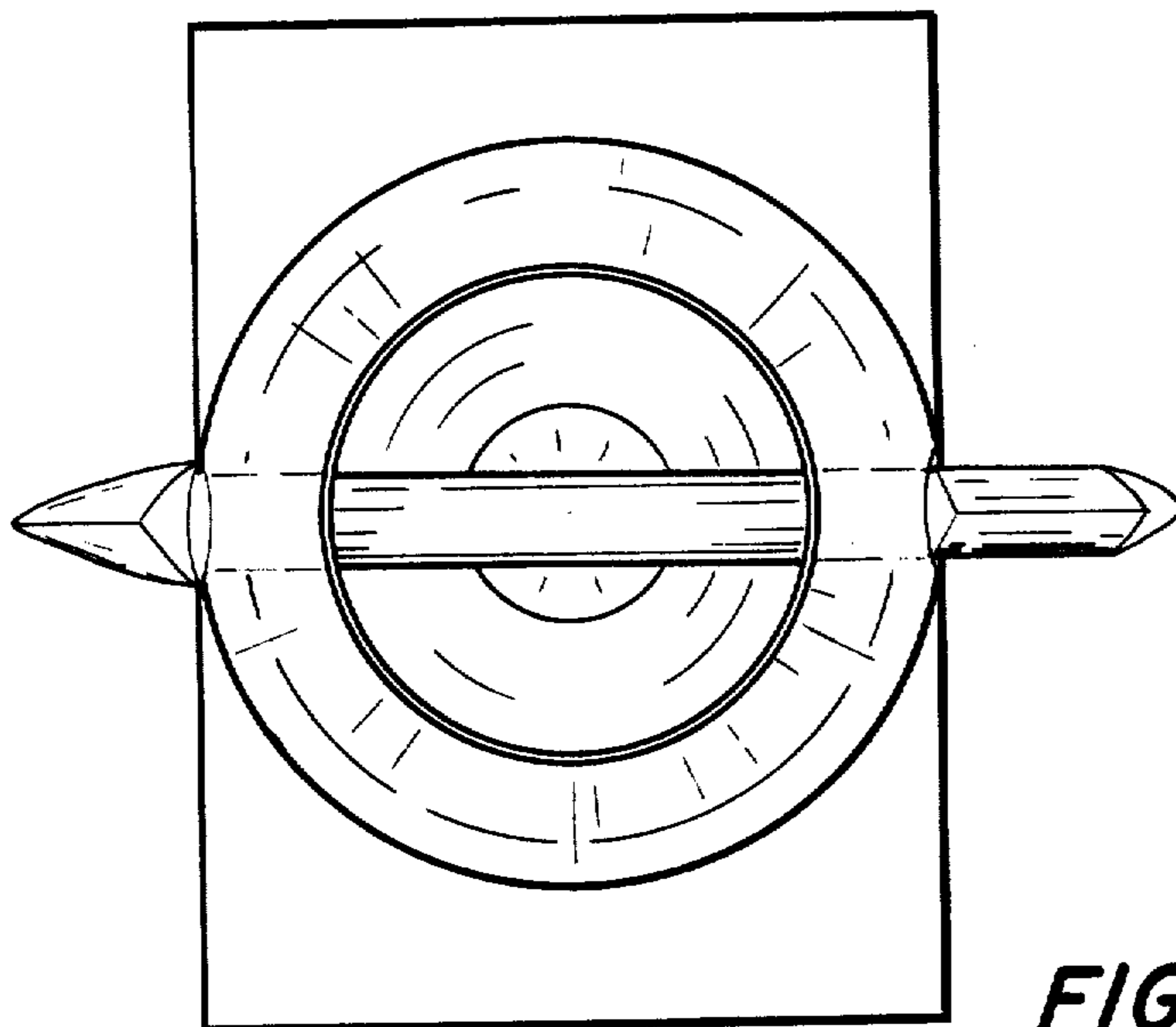

FIG-5

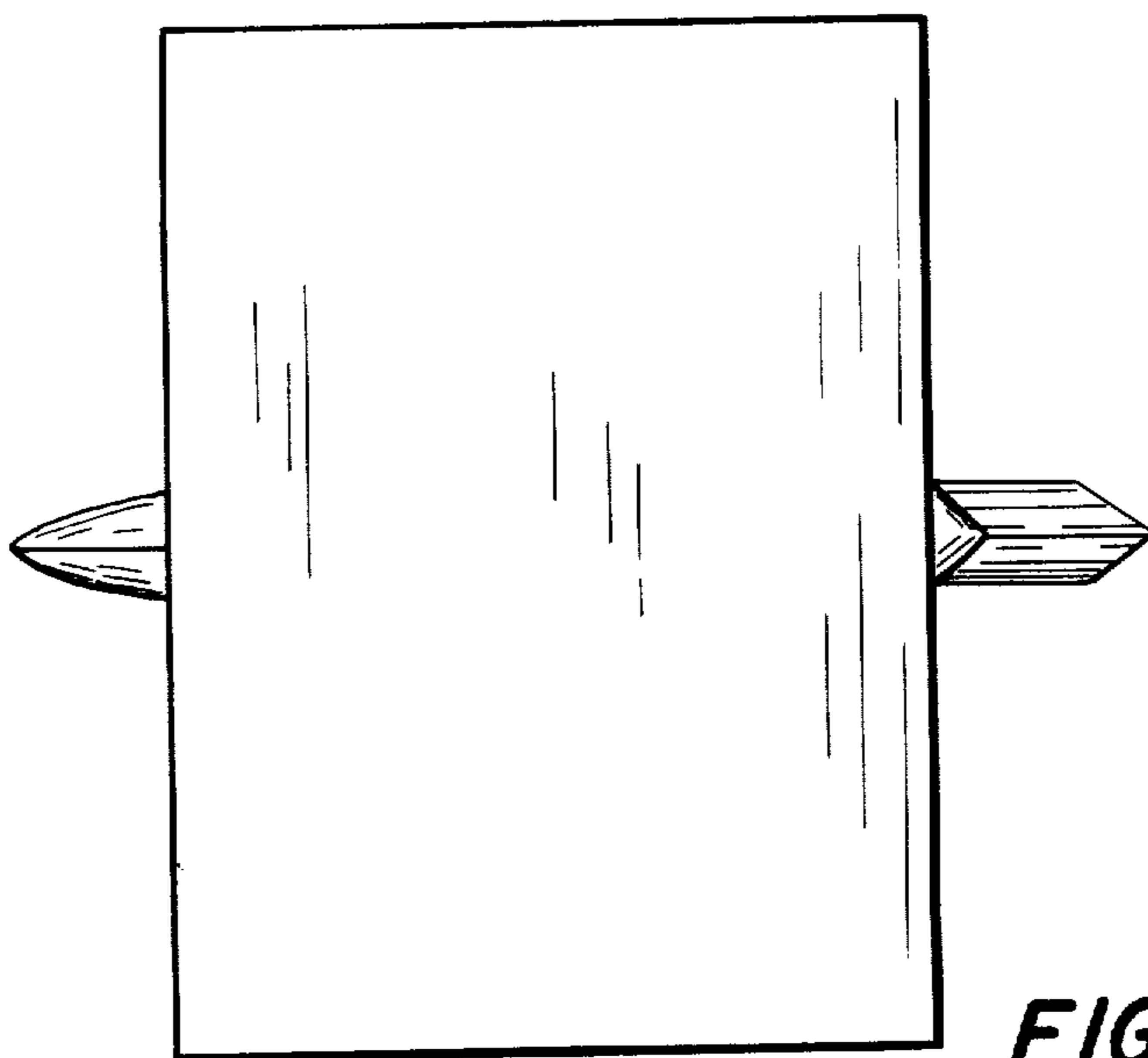

FIG-6