

[54] DISPLAY CARTON BLANK

[75] Inventor: Harry I. Roccaforte, Western Springs, Ill.

[73] Assignee: Champion International Corporation, Stamford, Conn.

[**] Term: 14 Years

[21] Appl. No.: 954,990

[22] Filed: Oct. 26, 1978

[51] Int. Cl. D9-03

[52] U.S. Cl. D9/433

[58] Field of Search 229/16 R, 16 D, 41 B, 229/52 B, 52 BC; 206/44 R, 45.19, 45.14; D9/245

[56] References Cited

U.S. PATENT DOCUMENTS

D. 252,559	8/1979	Bliss	D9/245
D. 252,915	9/1979	Wilson	D9/245
4,128,168	12/1978	Roccaforte	229/16 D X

Primary Examiner—Robert C. Spangler
Attorney, Agent, or Firm—Evelyn M. Sommer

[57] CLAIM

The ornamental design for a display carton blank, as shown and described.

DESCRIPTION

FIG. 1 is a perspective view of a display carton blank showing my new design, the opposite side being a mirror image of the side shown;

FIG. 2 is a perspective view showing a modified form of my new design, the opposite side being a mirror image of the side shown;

FIG. 3 is a perspective view of another modified form of my new design, the opposite side being a mirror image of the side shown;

FIG. 4 is a top plan view of the display carton blank of FIG. 1;

FIG. 5 is a top plan view of the display carton blank of FIG. 2; and

FIG. 6 is a top plan view of the display carton of FIG. 3.

The dash lines in the drawings represent fold lines.

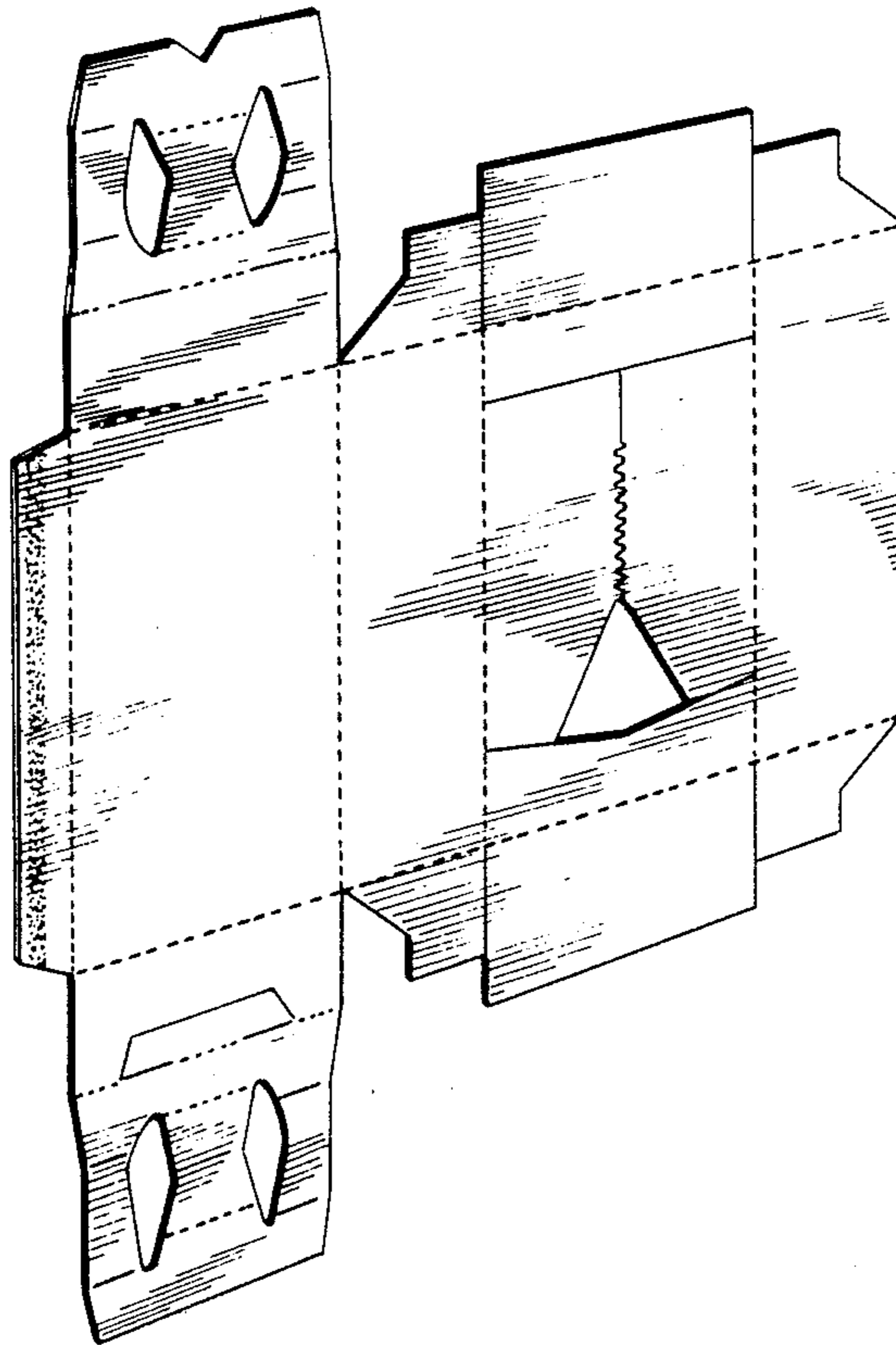

Fig. 1.

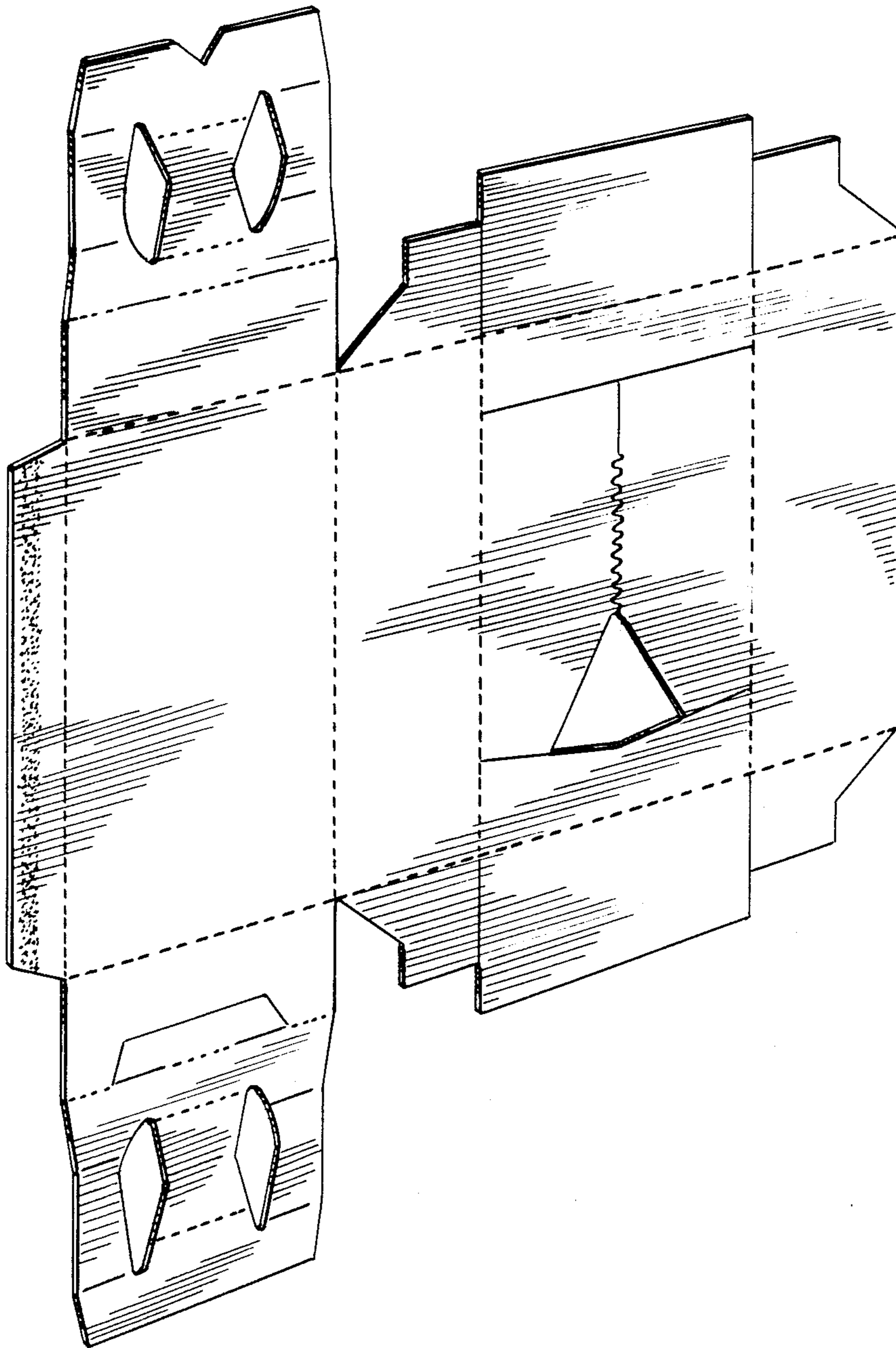

Fig. 2.

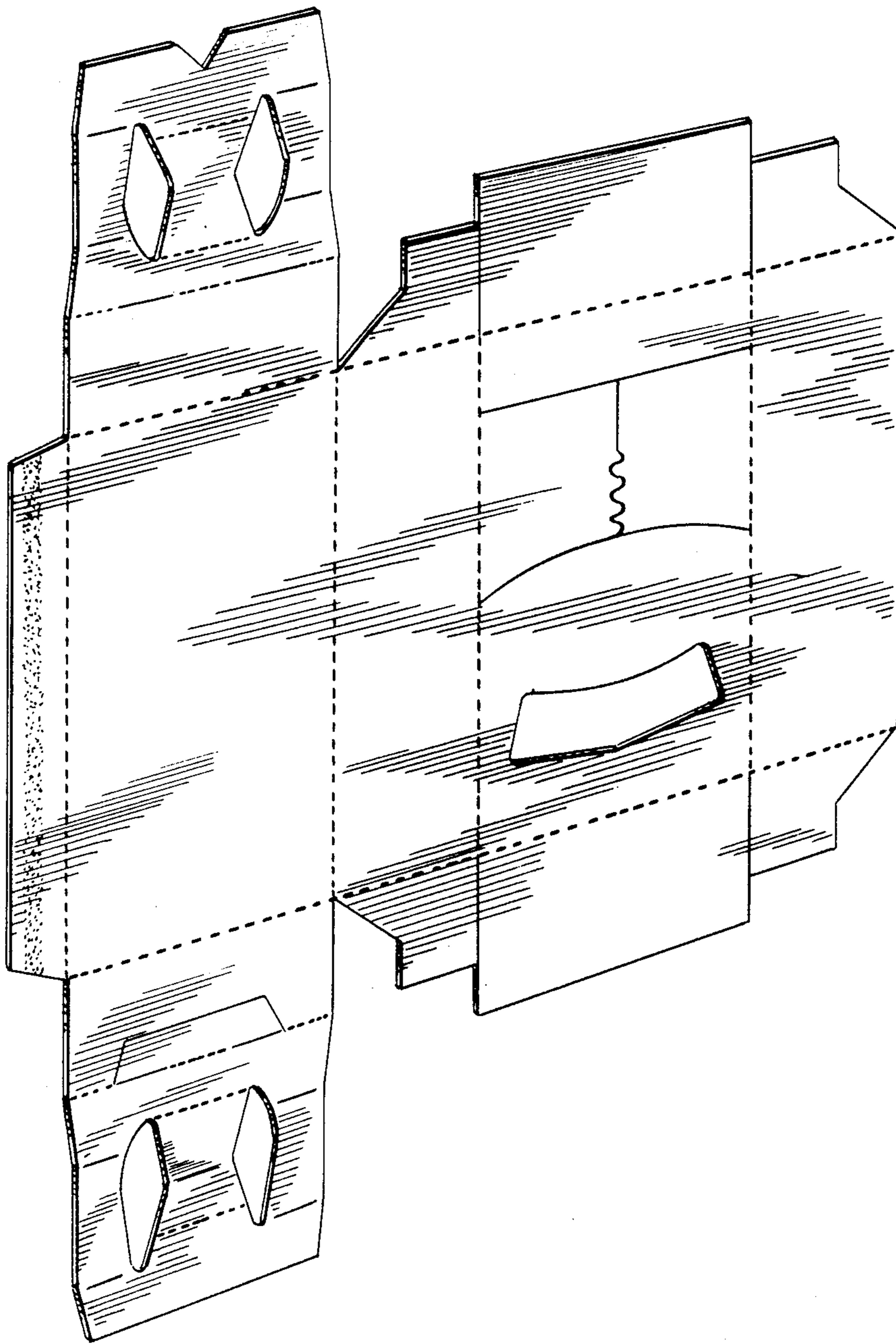
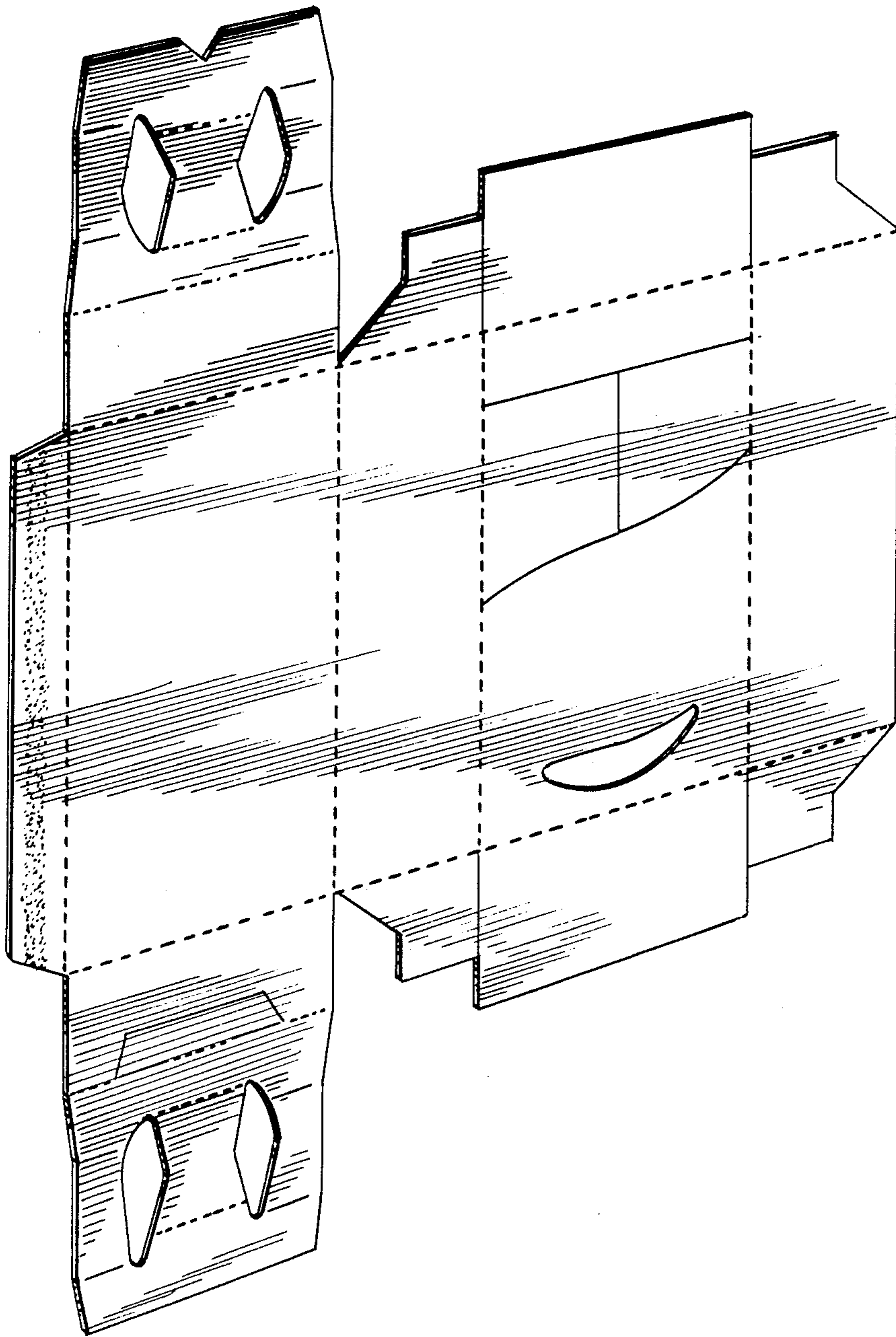

Fig. 3.



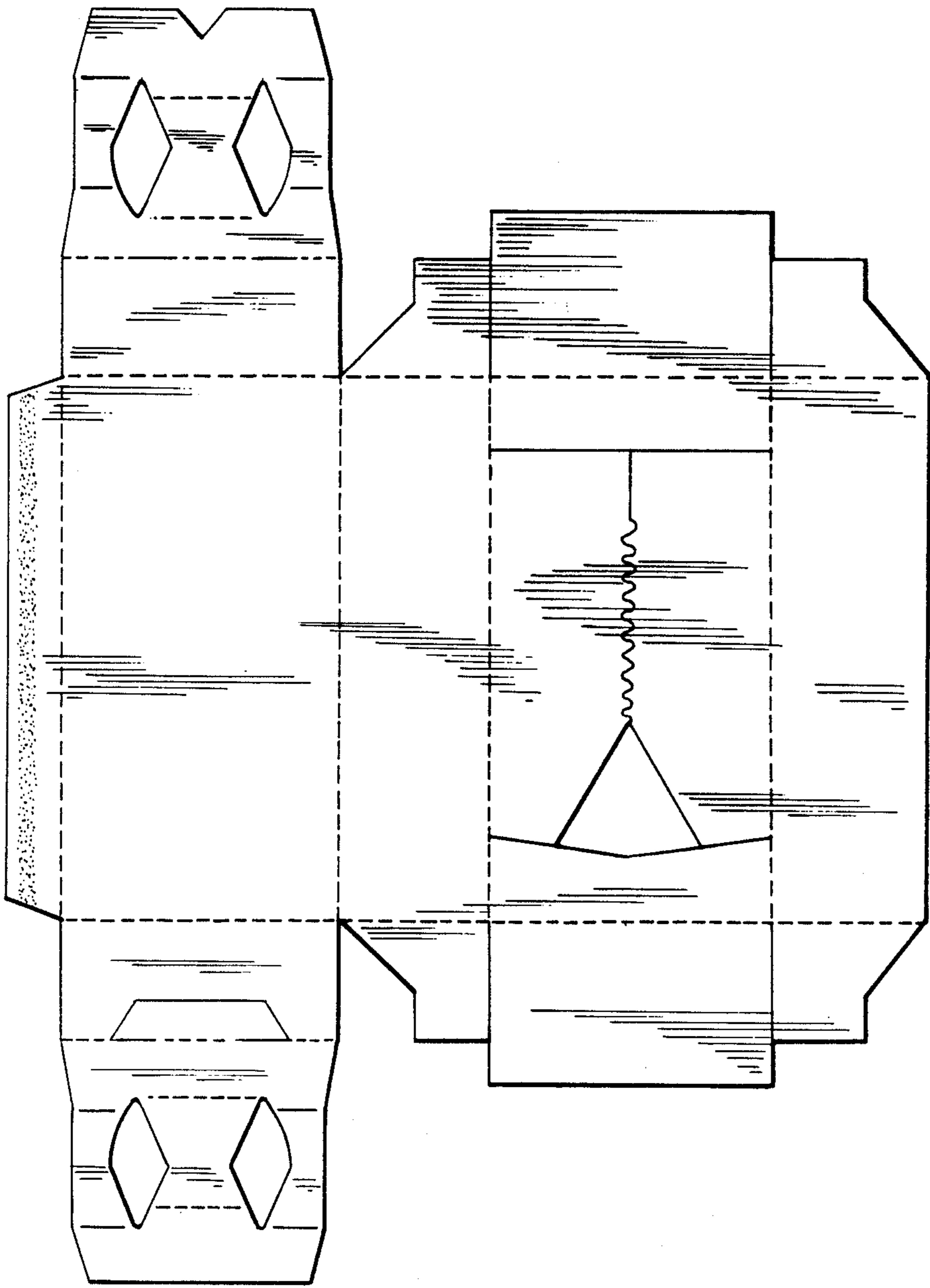

FIG. 4

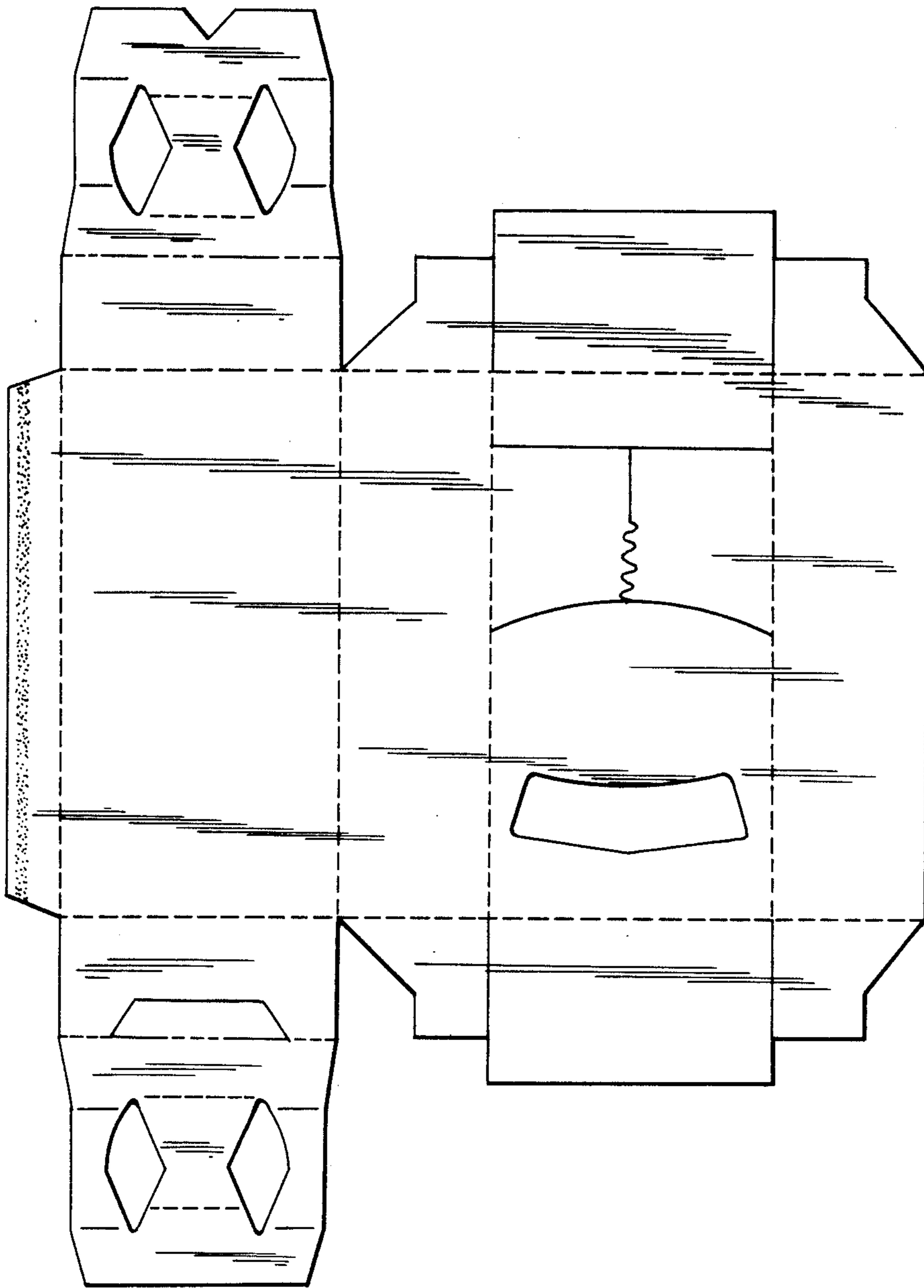

FIG. 5

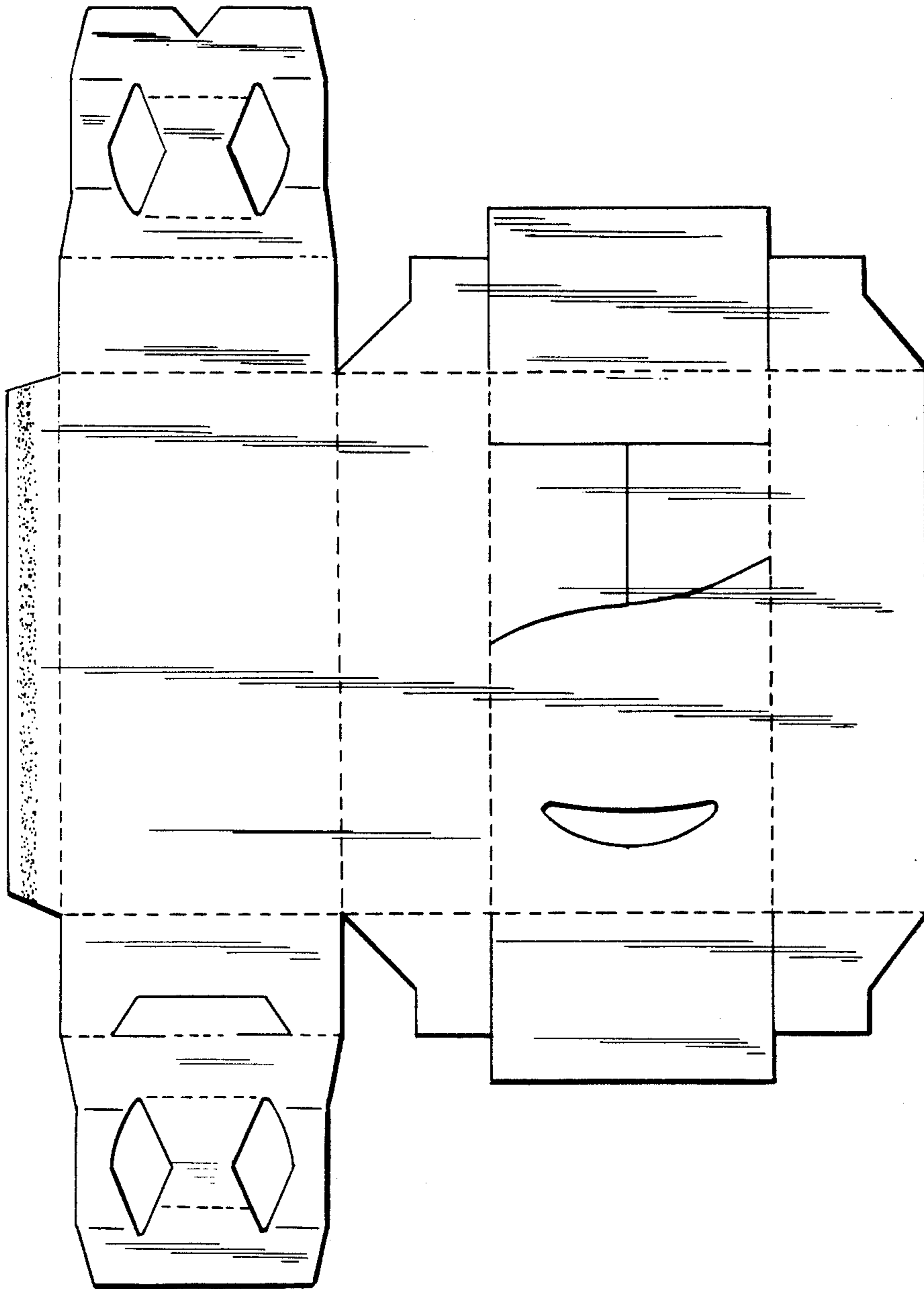

FIG. 6