

- [54] STORAGE TANK FOR LIQUIDS OR THE LIKE
- [75] Inventors: **Keisaku Koga**, Ibaraki; **Takeshi Iseda**, Yahata, both of Japan
- [73] Assignee: **Sekisui Koji Kabushiki Kaisha**, Japan
- [**] Term: **14 Years**
- [21] Appl. No.: **951,355**
- [22] Filed: **Oct. 13, 1978**
- [30] Foreign Application Priority Data
 Apr. 24, 1978 [JP] Japan 53-16615
- [51] Int. Cl. **D23-01**
- [52] U.S. Cl. **D23/2**
- [58] Field of Search **D9/175, 246; D23/2; 220/1 B**

- [56] **References Cited**
U.S. PATENT DOCUMENTS
 D. 51,545 12/1917 **Blake** D23/2
 D. 239,506 4/1976 **Myers** D9/175

- D. 245,319 8/1977 **Wodell** D9/246
- D. 251,674 4/1979 **Sayward** D23/2

Primary Examiner—Robert C. Spangler
Attorney, Agent, or Firm—William B. Cunningham, Jr.

[57] **CLAIM**

The ornamental design for a storage tank for liquids or the like, as shown.

DESCRIPTION

FIG. 1 is a perspective view of a storage tank for liquids or the like, showing our new design;
 FIG. 2 is a top plan view;
 FIG. 3 is a front elevational view;
 FIG. 4 is an elevational view looking from the left of FIG. 3, the opposite side being a mirror image of the side shown;
 FIG. 5 is a rear elevational view;
 FIG. 6 is a bottom plan view;
 FIG. 7 is a vertical sectional view taken along line 7—7 of FIG. 3; and
 FIG. 8 is a horizontal sectional view taken along 8—8 of FIG. 4.

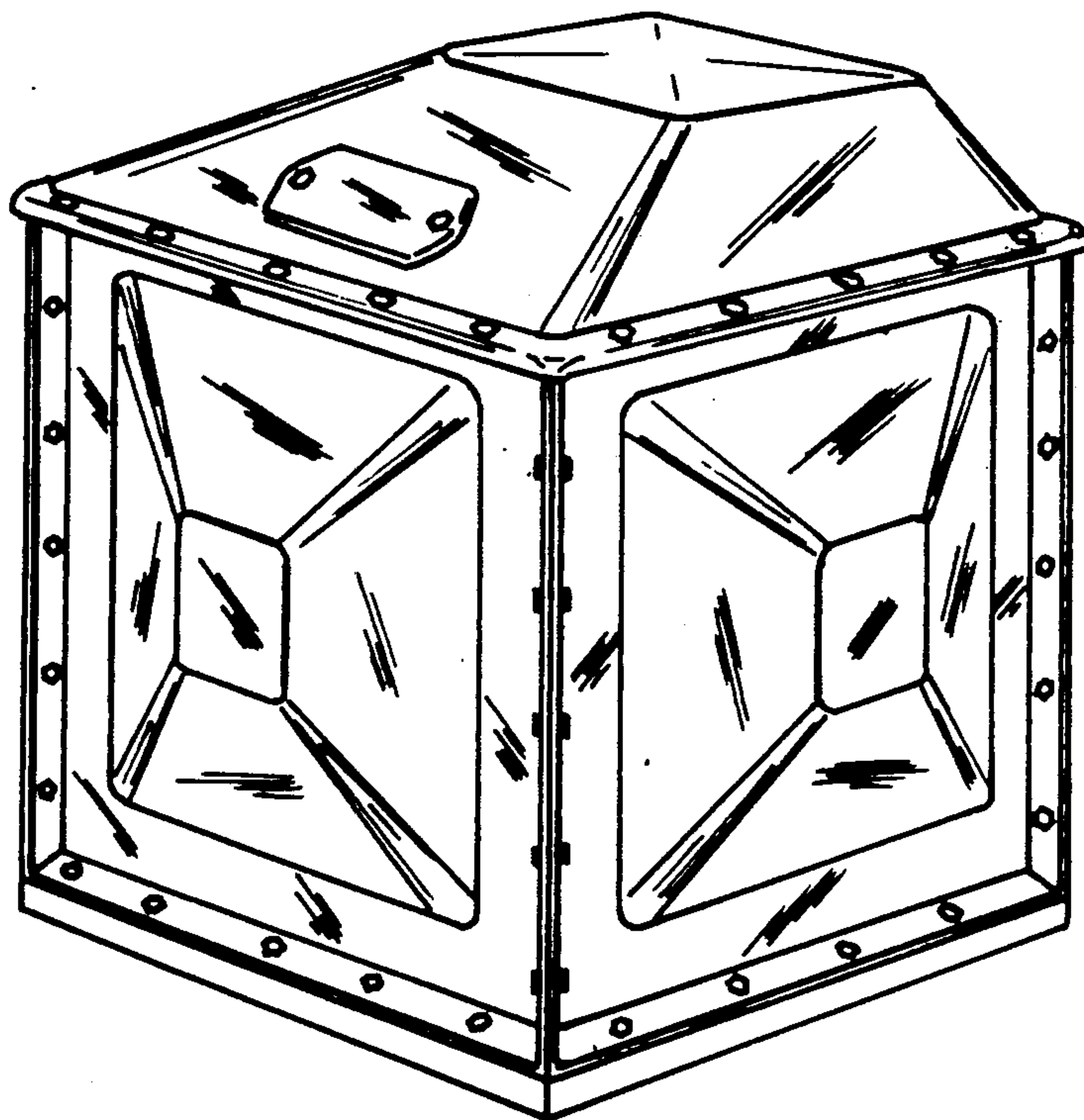

FIG. 1

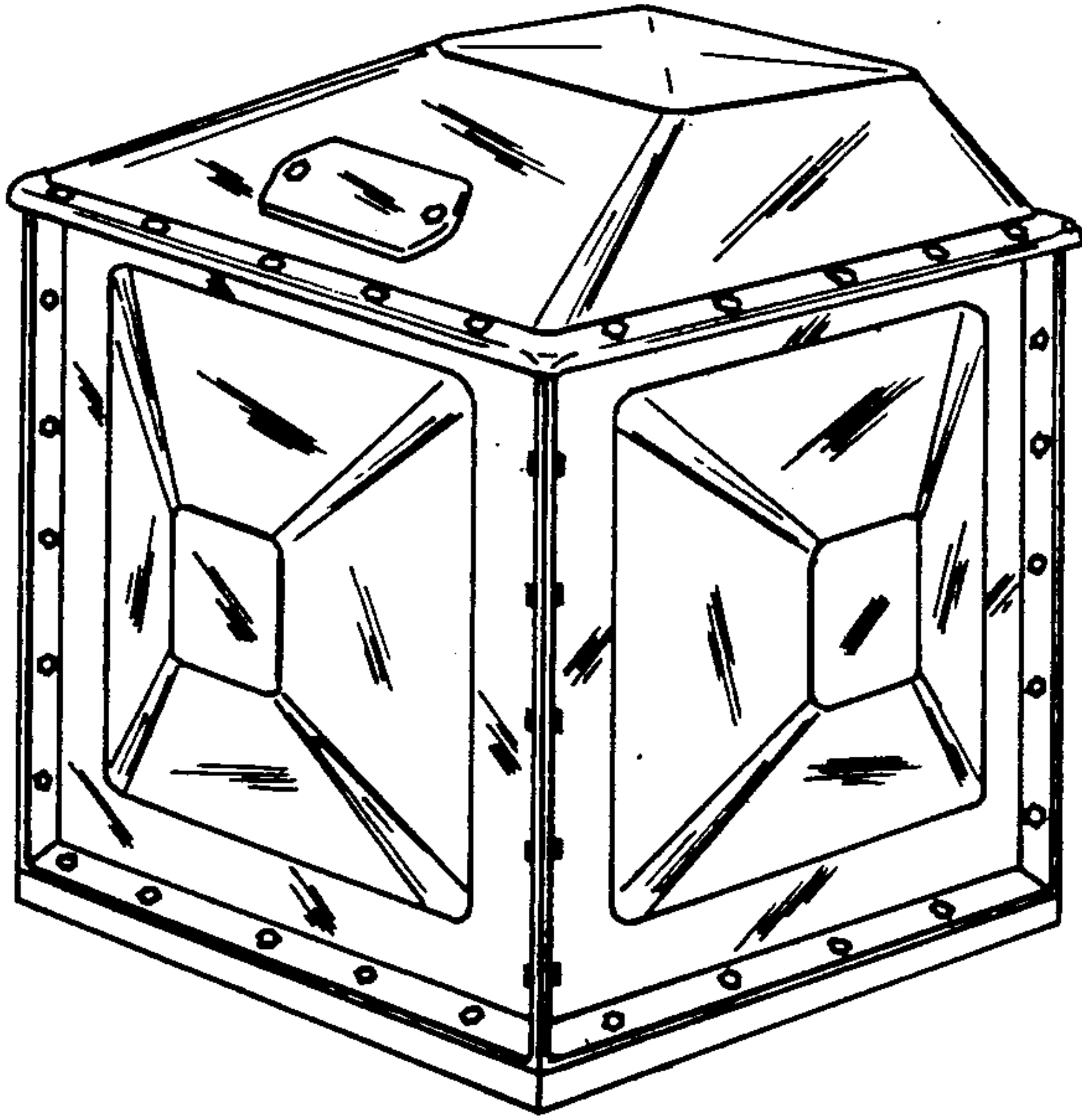

FIG. 2

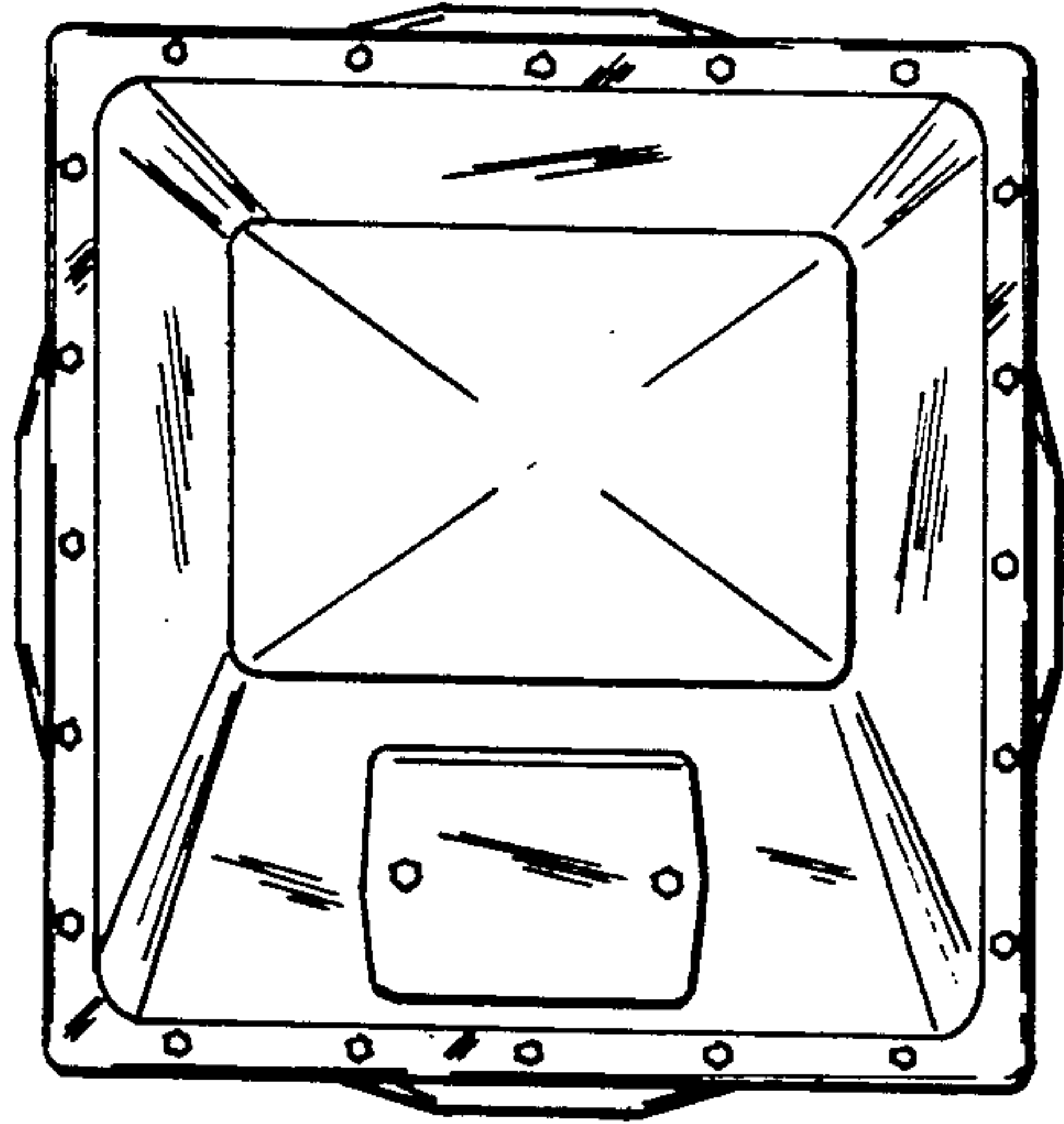

FIG. 3

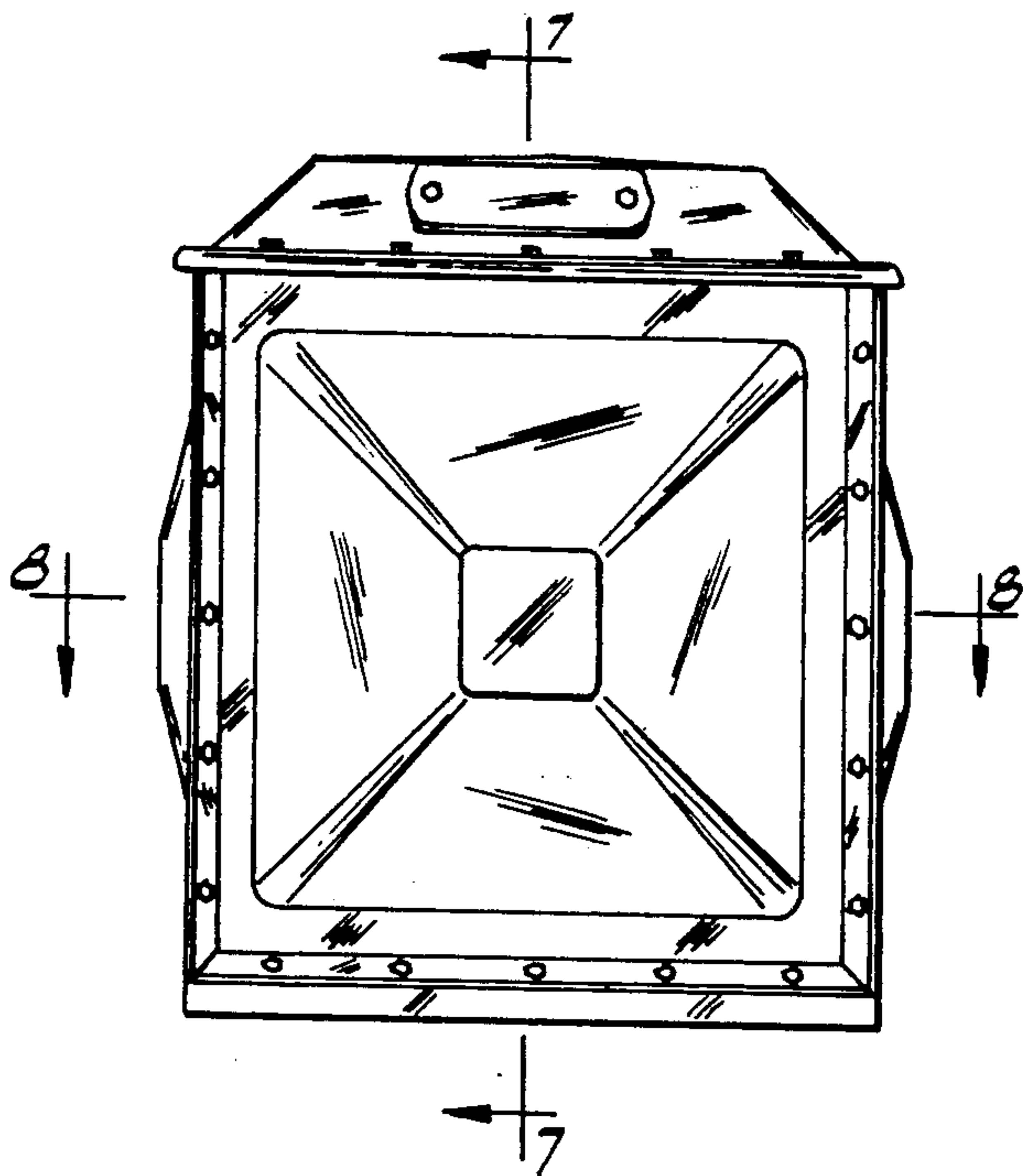

FIG. 4

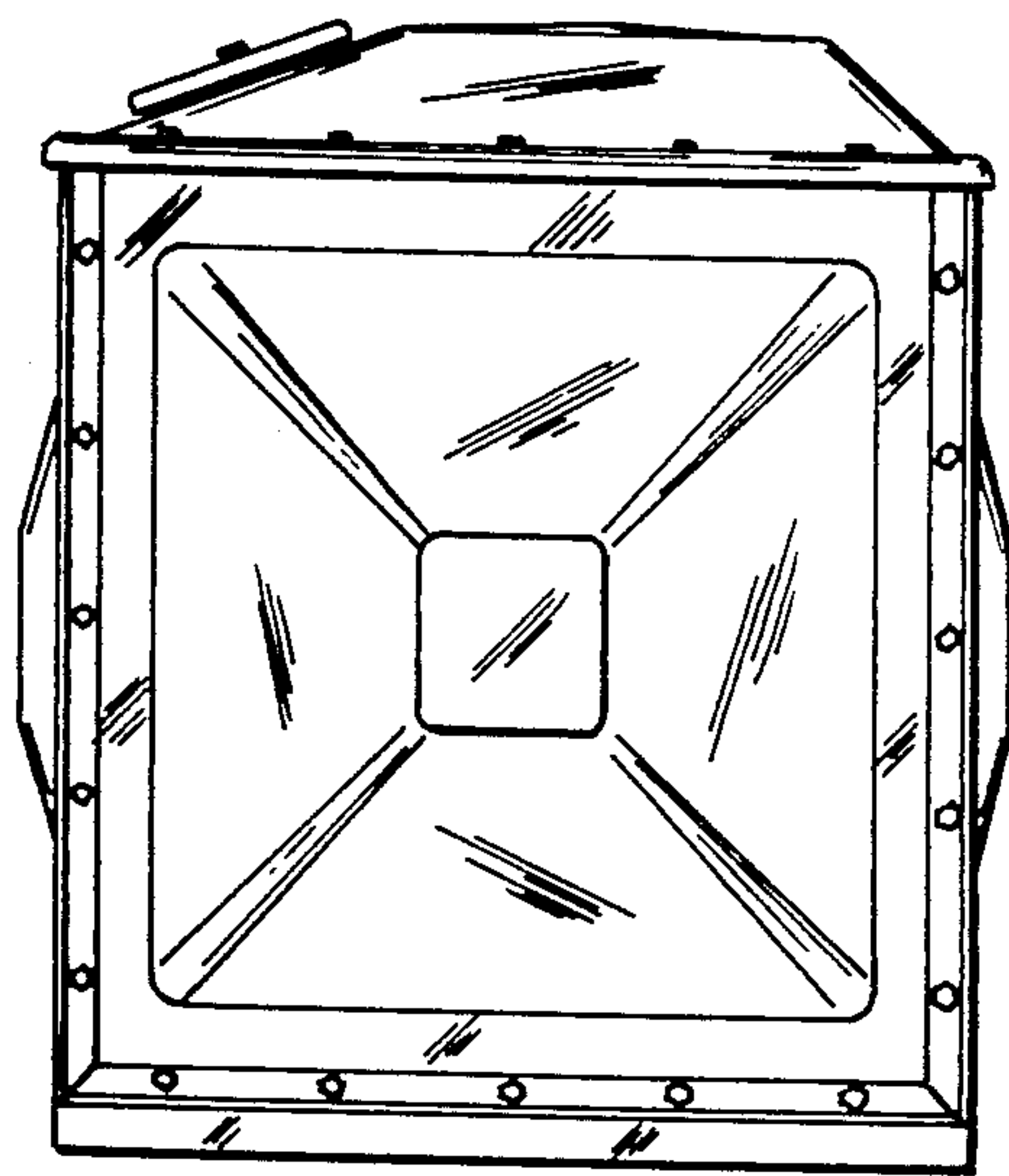

FIG. 5

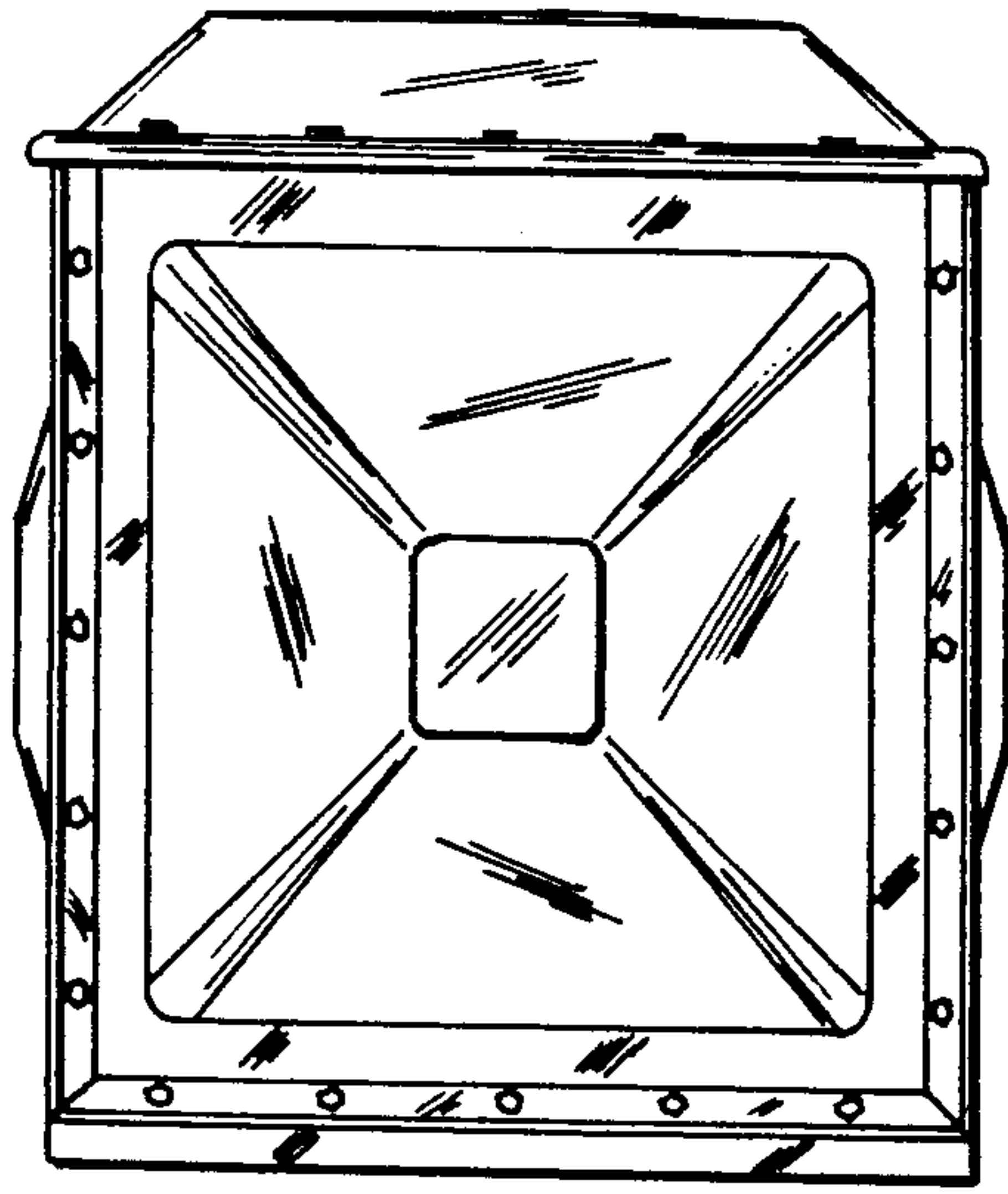

FIG. 6

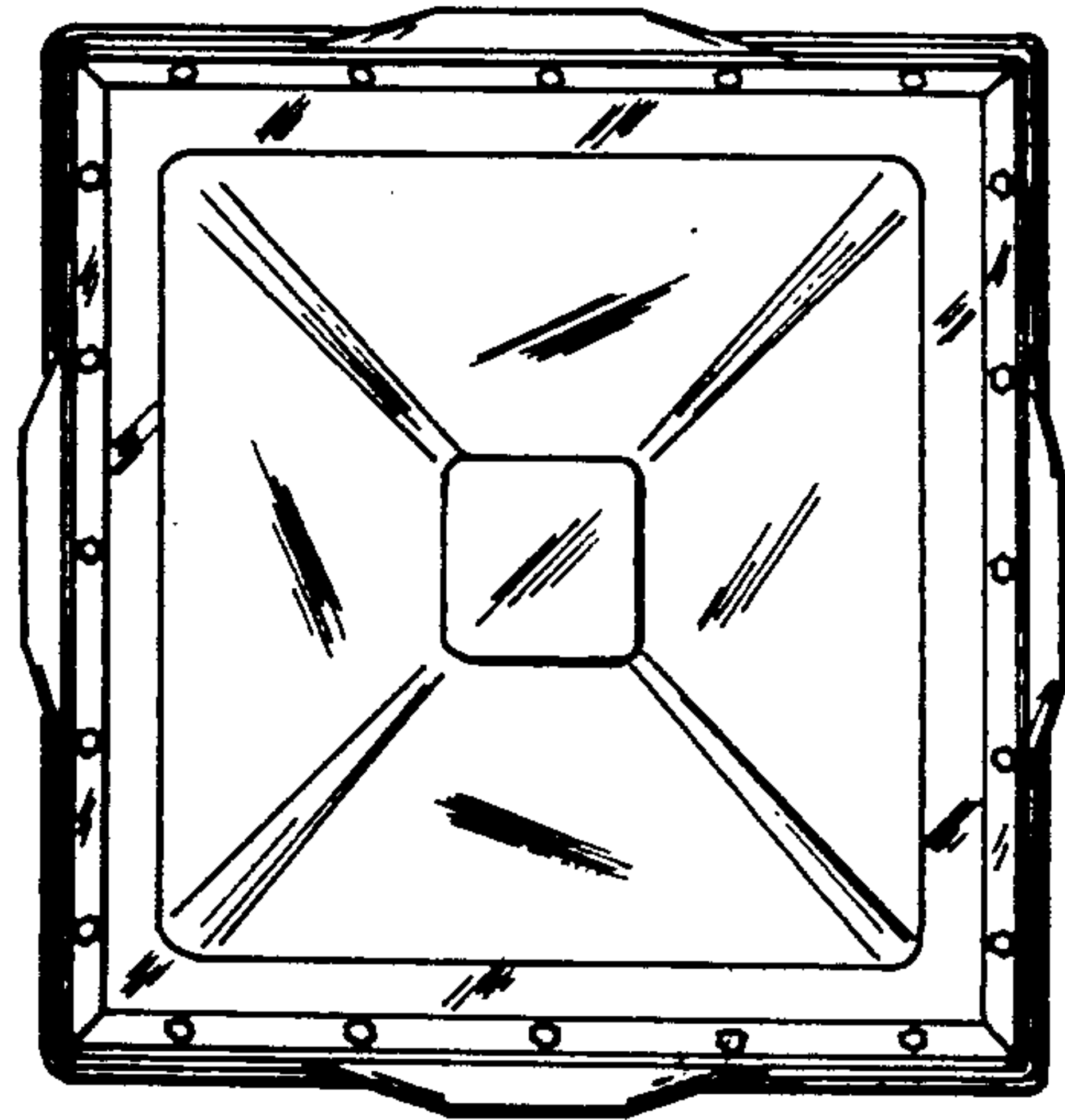

FIG. 7

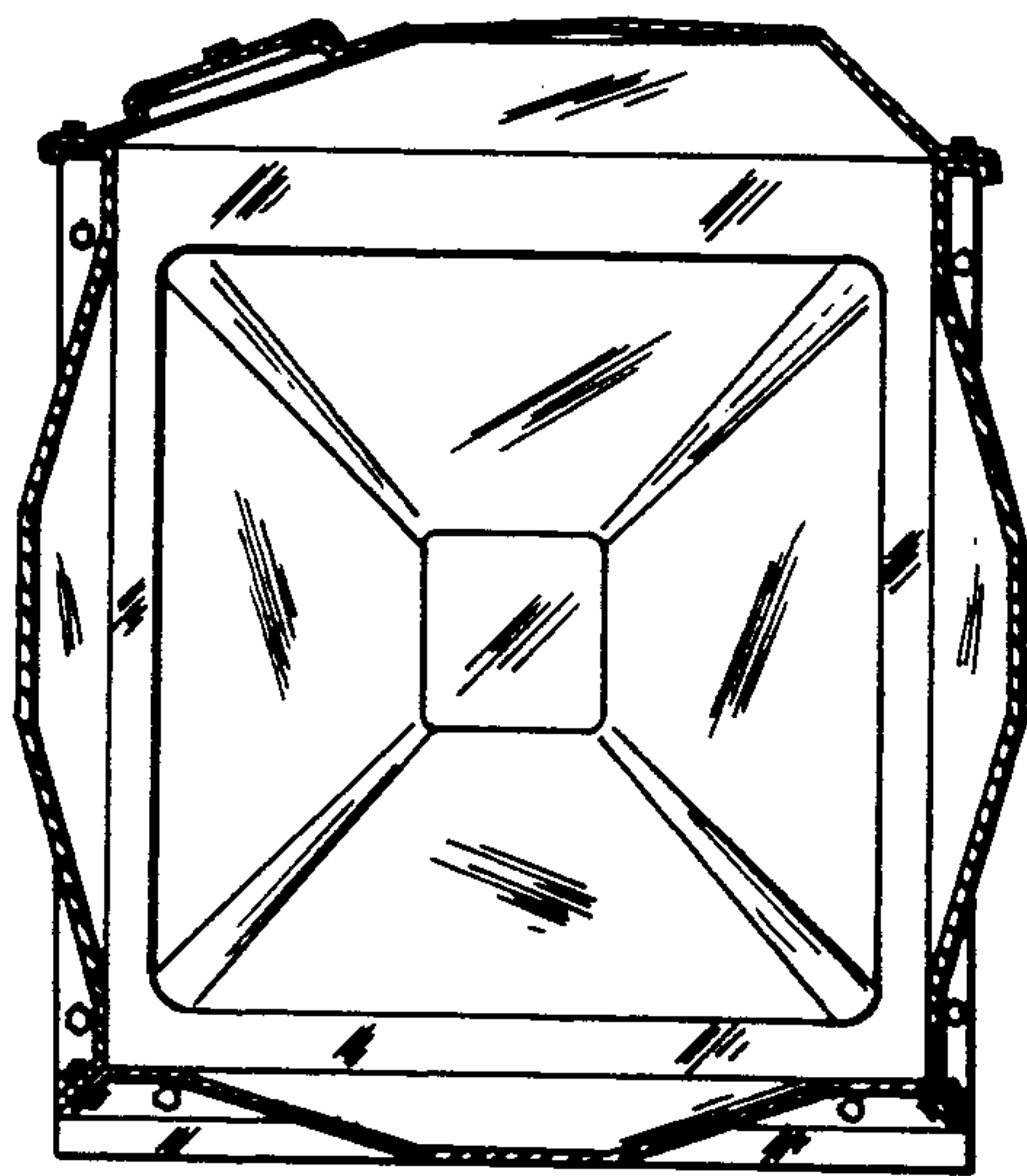

FIG. 8

