

[54] **HOOK**

[75] **Inventor:** Lee R. Chasen, Port Chester, N.Y.

[73] **Assignee:** Coats & Clark, Inc., Stamford, Conn.

[**] **Term:** 14 Years

[21] **Appl. No.:** 952,584

[22] **Filed:** Oct. 18, 1978

[51] **Int. Cl.** D8-08

[52] **U.S. Cl.** D8/367; D8/373

[58] **Field of Search** 248/304, 339, 290, 306, 248/341, 340; D6/114, 120; D8/354, 356, 360, 363, 367, 368, 369, 270, 371, 373, 382, 383

3,055,333 9/1962 Ryan D8/356 X
 3,298,652 1/1967 Burdick 248/304 X
 3,995,822 12/1976 Einhorn et al. 248/304
 4,174,087 11/1979 Gaines 248/339

Primary Examiner—A. Hugo Word
Attorney, Agent, or Firm—Burgess, Ryan and Wayne

[57] **CLAIM**

The ornamental design for a hook, substantially as shown and described.

DESCRIPTION

FIG. 1 is a perspective view of a hook according to my design;
 FIG. 2 is a front elevation view of my design, the rear elevation view being a mirror image of said front elevation view;
 FIG. 3 is an enlarged left side elevation view thereof;
 FIG. 4 is a right side elevation view thereof;
 FIG. 5 is a top plan view thereof; and
 FIG. 6 is a bottom plan view thereof.

[56] **References Cited**
U.S. PATENT DOCUMENTS
 1,795,059 3/1931 Vance et al. 248/304
 2,275,007 3/1942 Caestecker 248/304 X

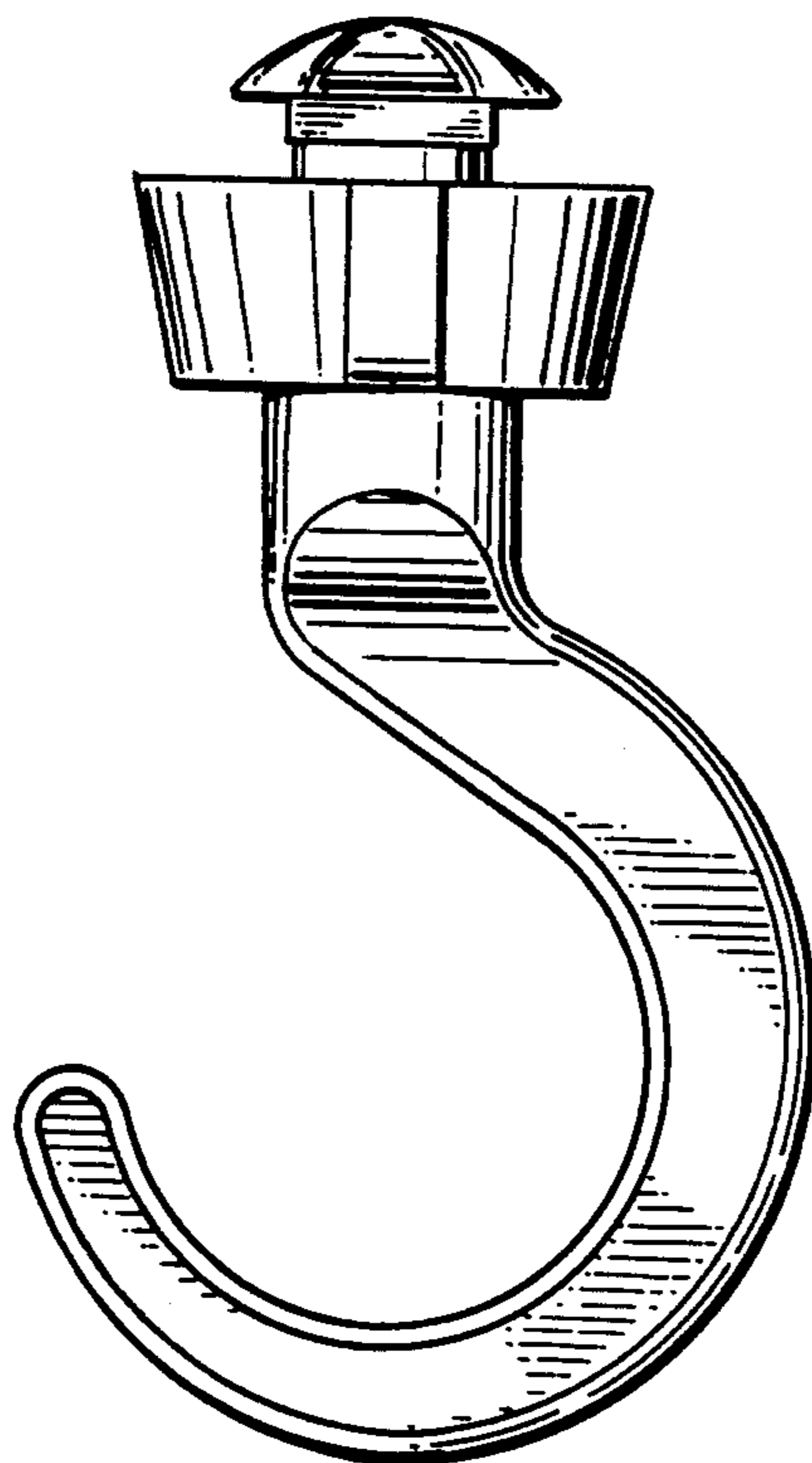

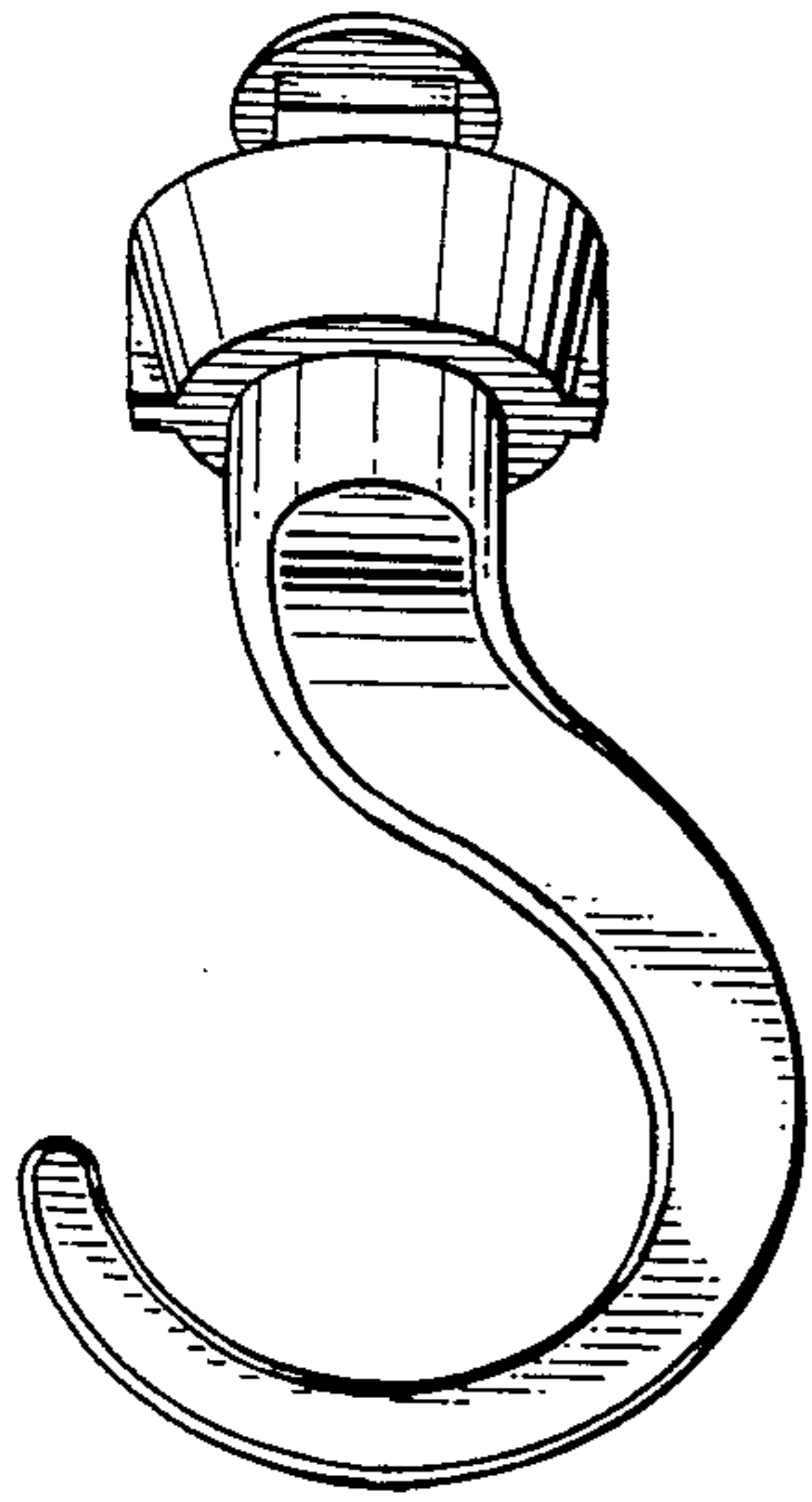

FIG. 1

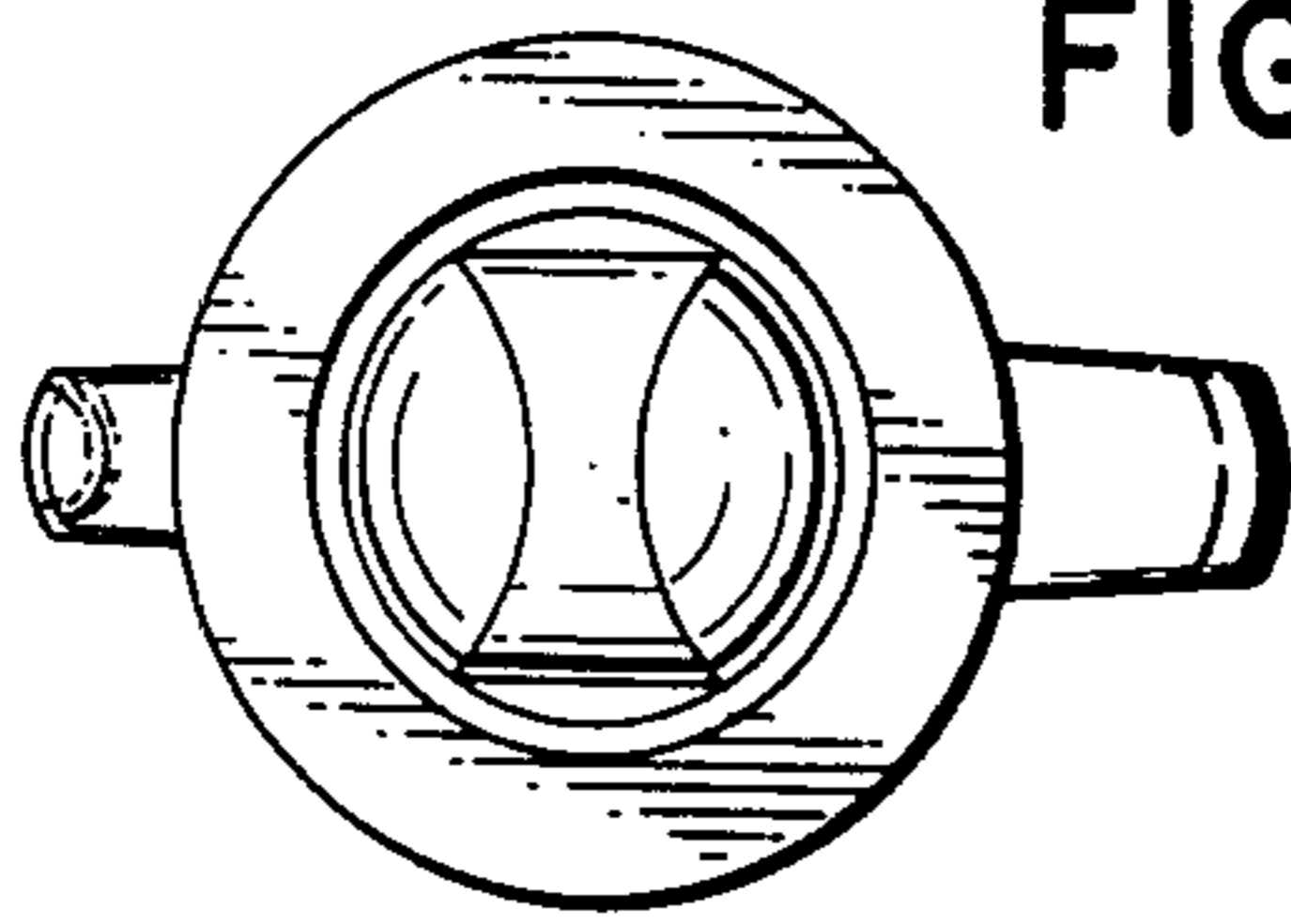

FIG. 5

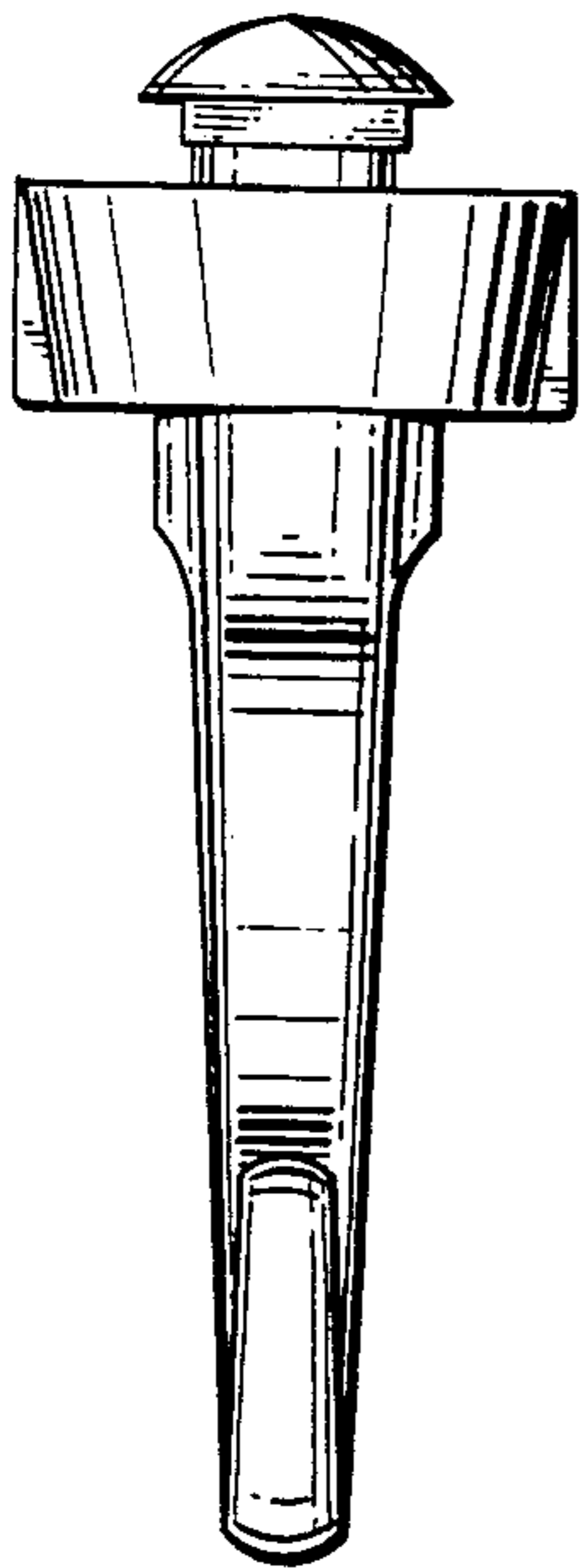

FIG. 3

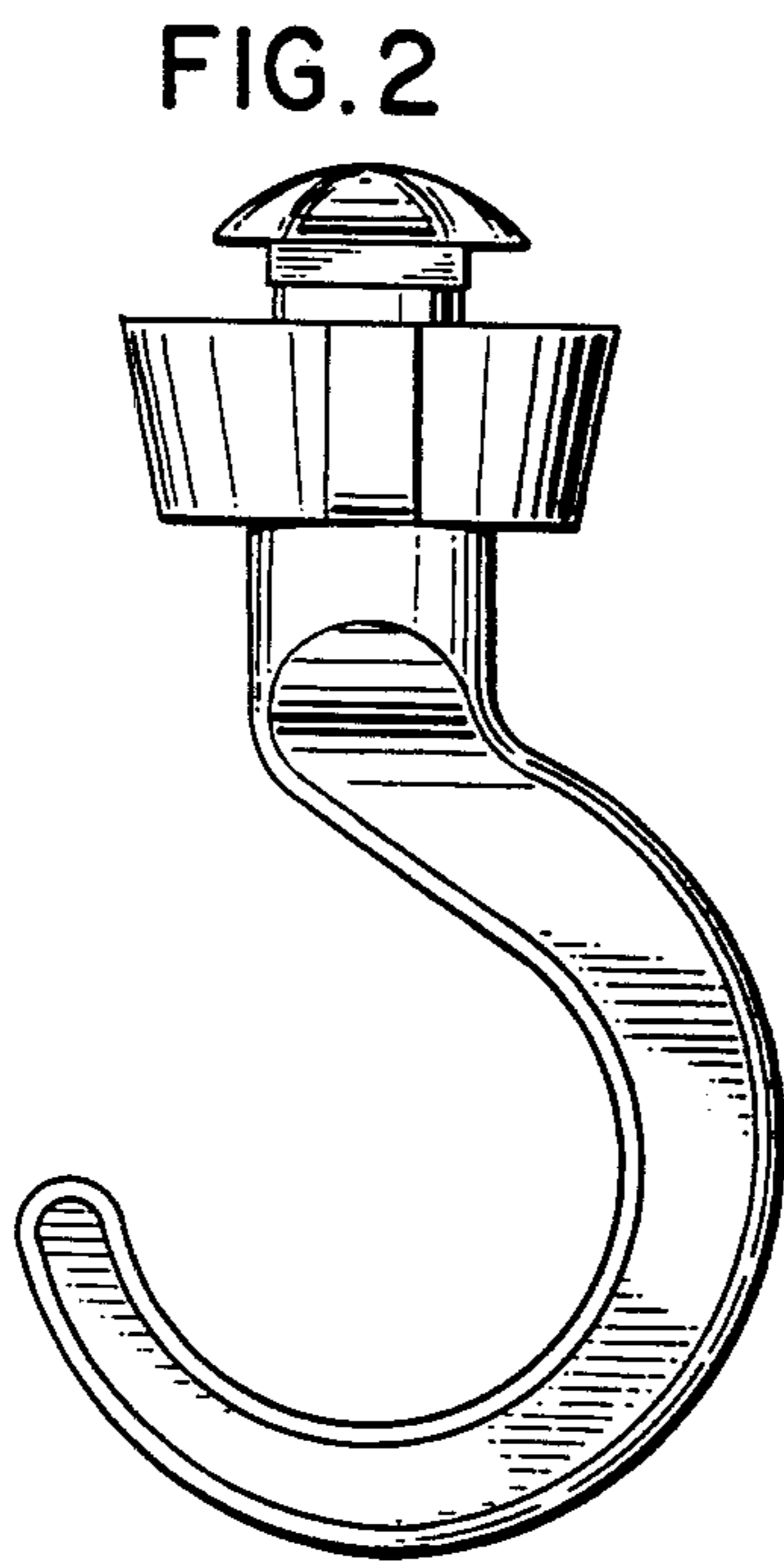

FIG. 2

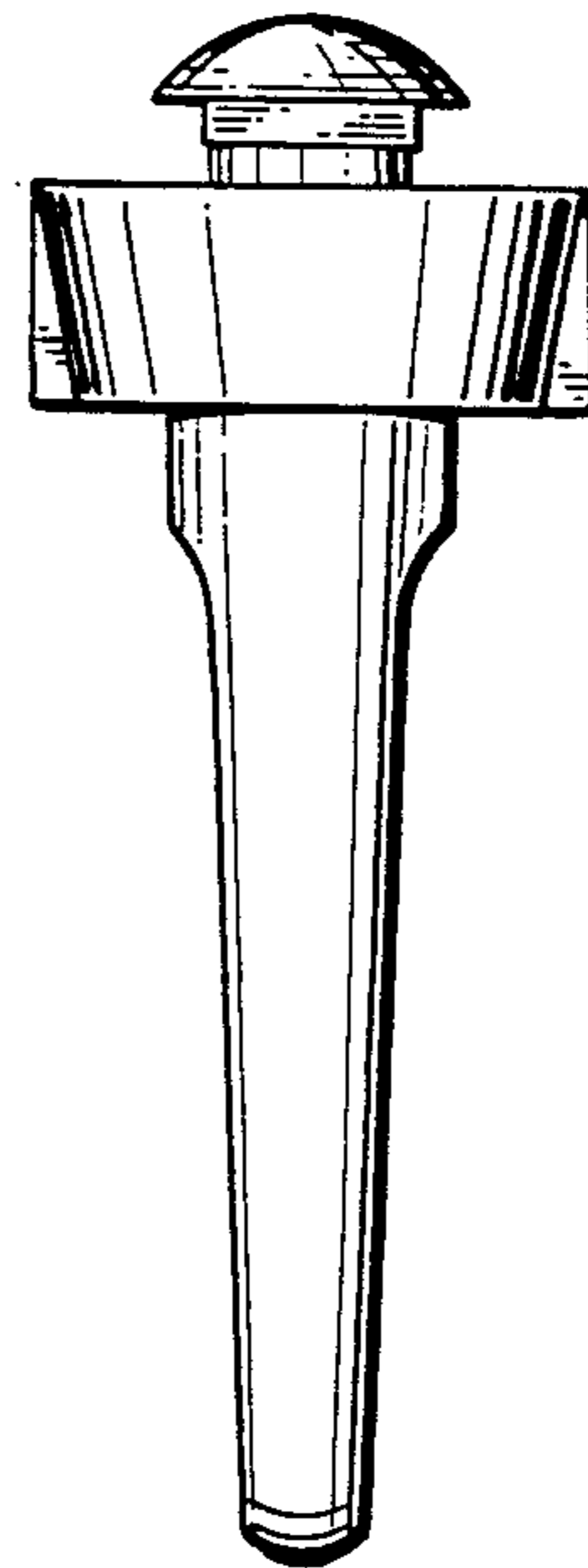

FIG. 4

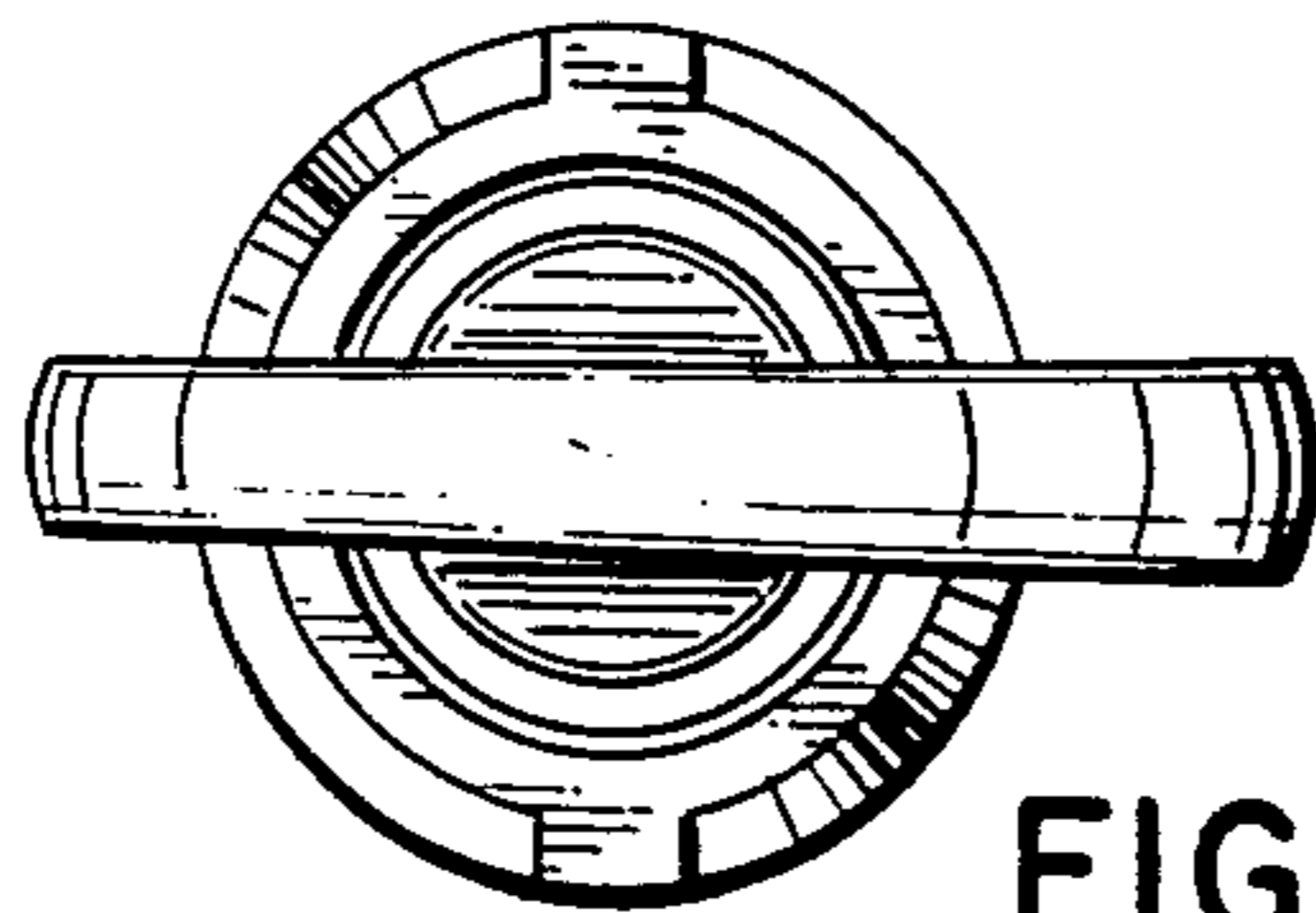

FIG. 6