

[54] CHAISE LOUNGE

D. 185,540 6/1959 Everly ..... D6/60

[75] Inventor: Joseph W. Sroub, Parma, Ohio

OTHER PUBLICATIONS

[73] Assignee: Cardinal American Corporation, Cleveland, Ohio

"Monterey Bay Line", Cat. by Harris, p. 11, Lounge No. 735.

[\*\*] Term: 14 Years

Primary Examiner—Bruce W. Dunkins  
Attorney, Agent, or Firm—Isler and Ornstein

[21] Appl. No.: 1,375

[57] CLAIM

[22] Filed: Jan. 5, 1979

The ornamental design for a chaise lounge, substantially as shown.

[51] Int. Cl. .... D6-01

[52] U.S. Cl. .... D6/38; D6/76

[58] Field of Search ..... D6/37-39,  
D6/47-78

DESCRIPTION

FIG. 1 is a perspective view of a chaise lounge, showing my new design;

FIG. 2 is a side elevational view;

FIG. 3 is a top plan view;

FIG. 4 is a bottom plan view;

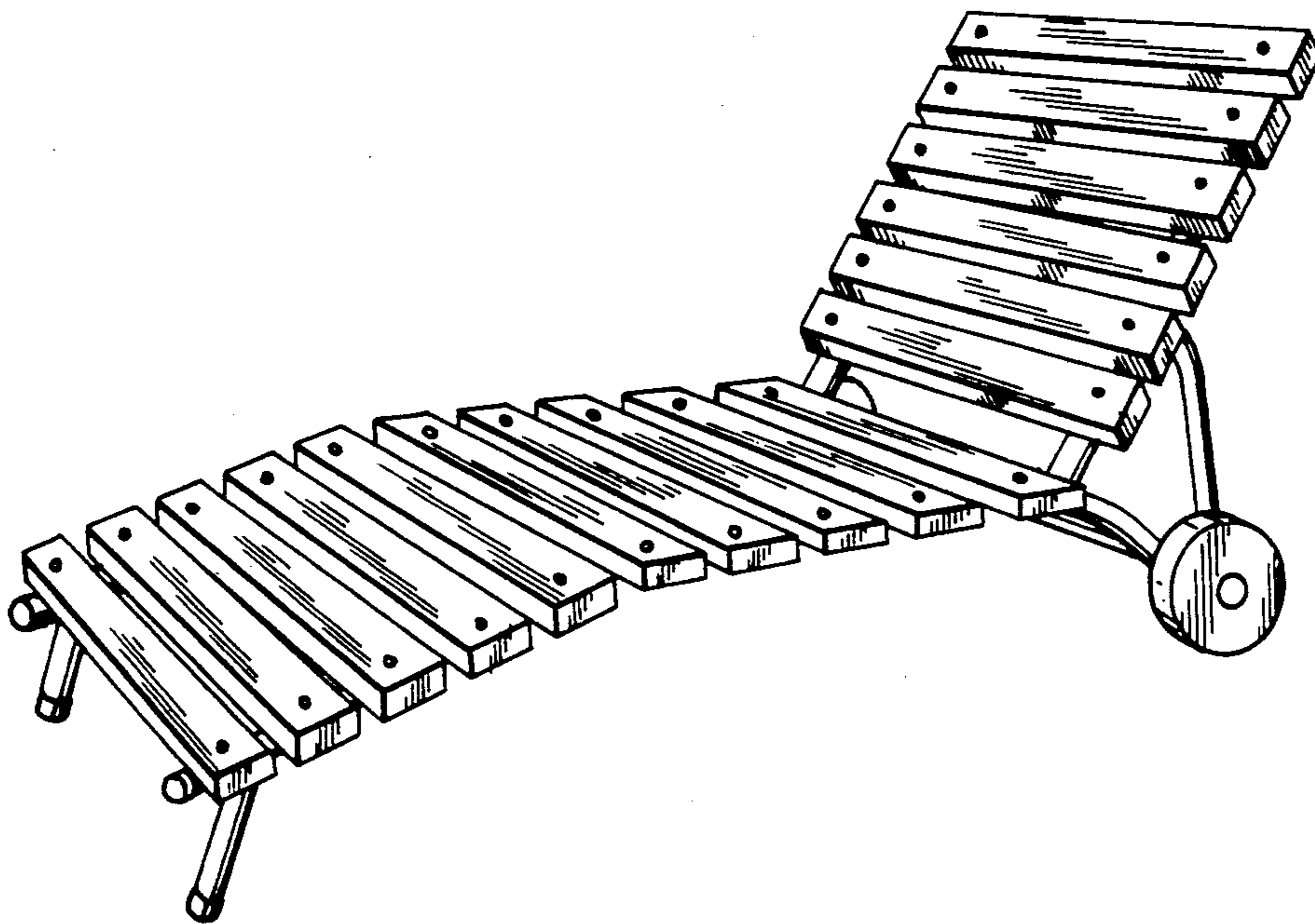
FIG. 5 is a front elevational view; and

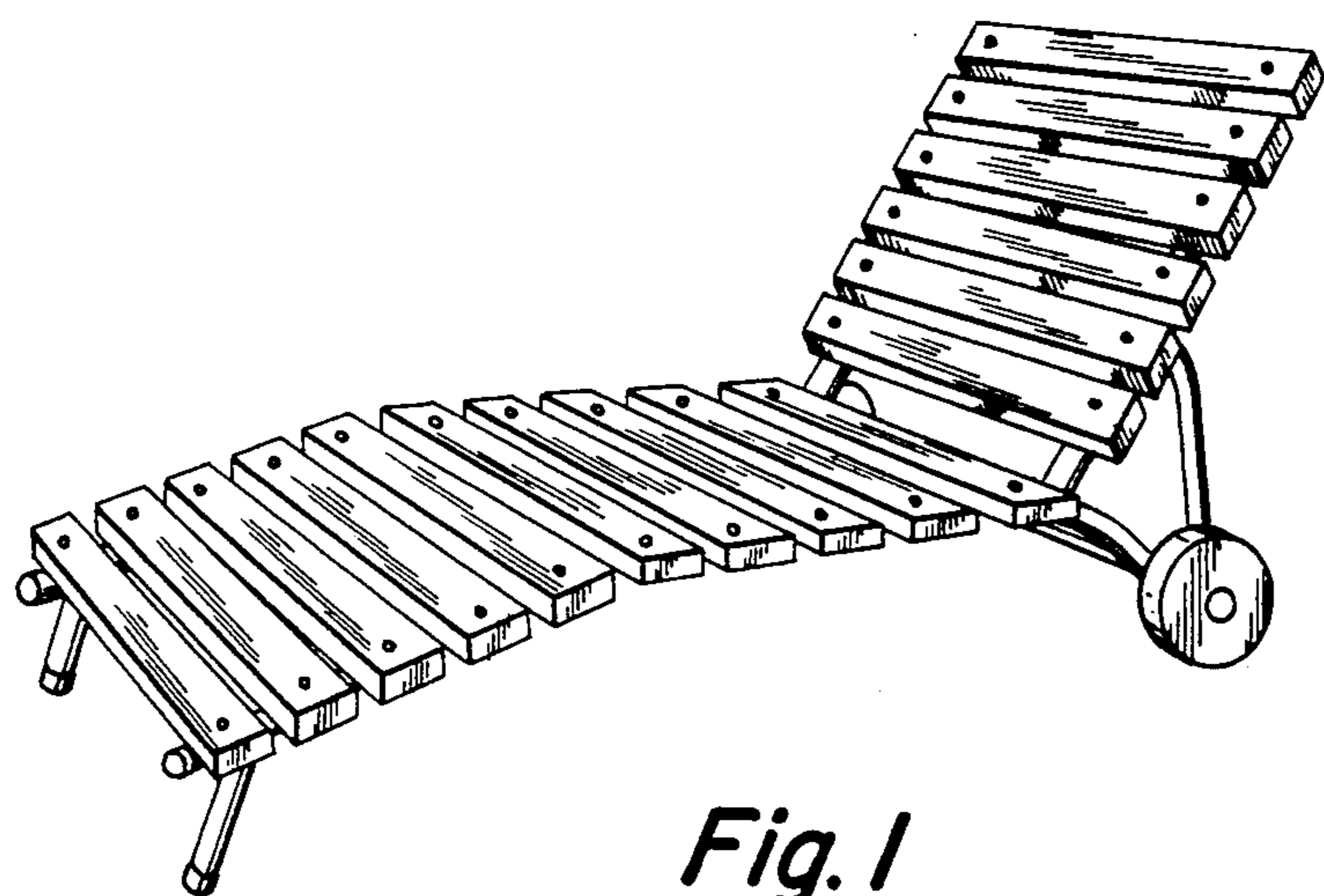
FIG. 6 is a rear elevational view thereof.

[56] References Cited

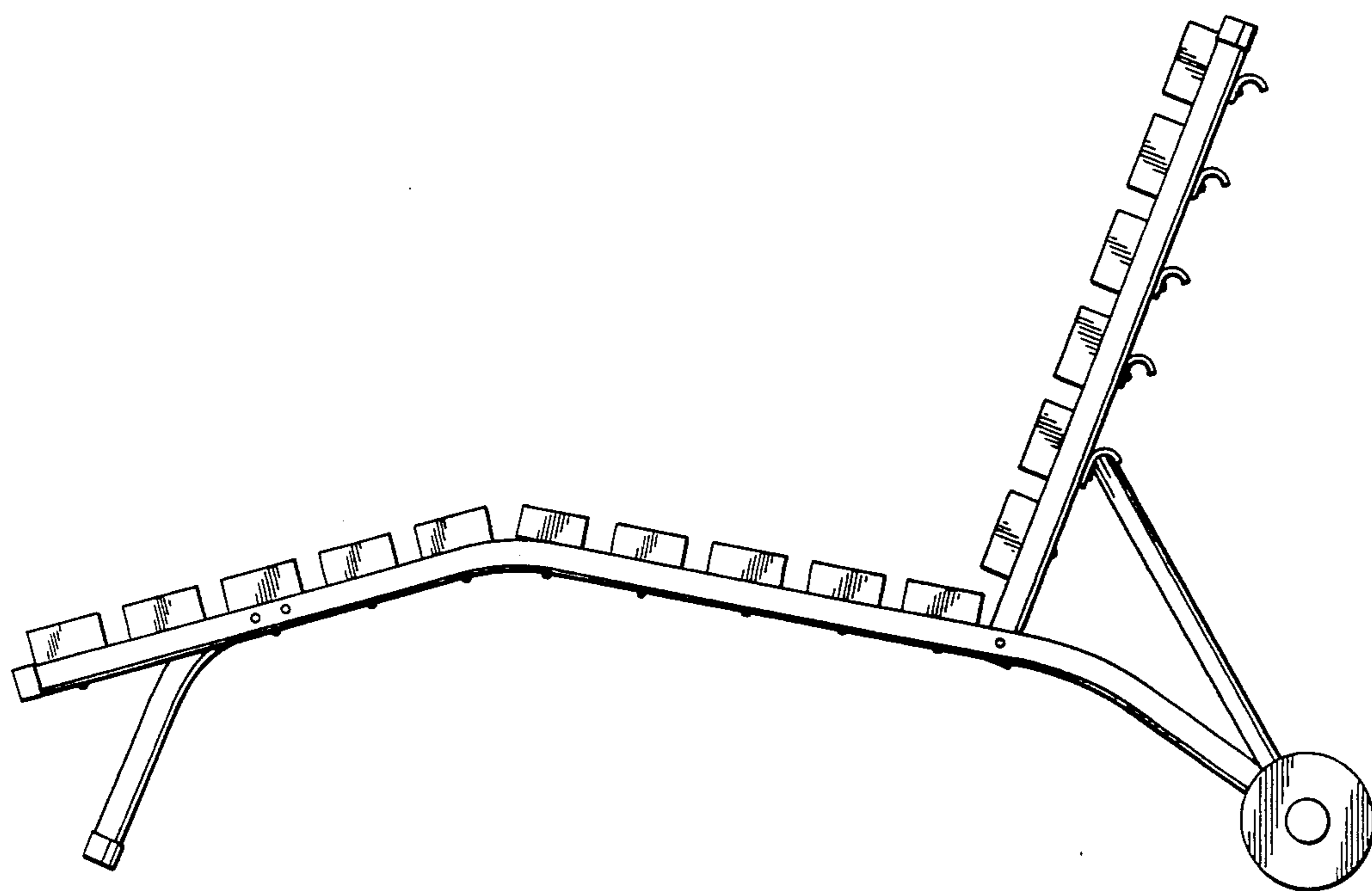
U.S. PATENT DOCUMENTS

- D. 135,417 4/1943 Smith ..... D6/38
- D. 181,152 10/1957 Jones ..... D6/38

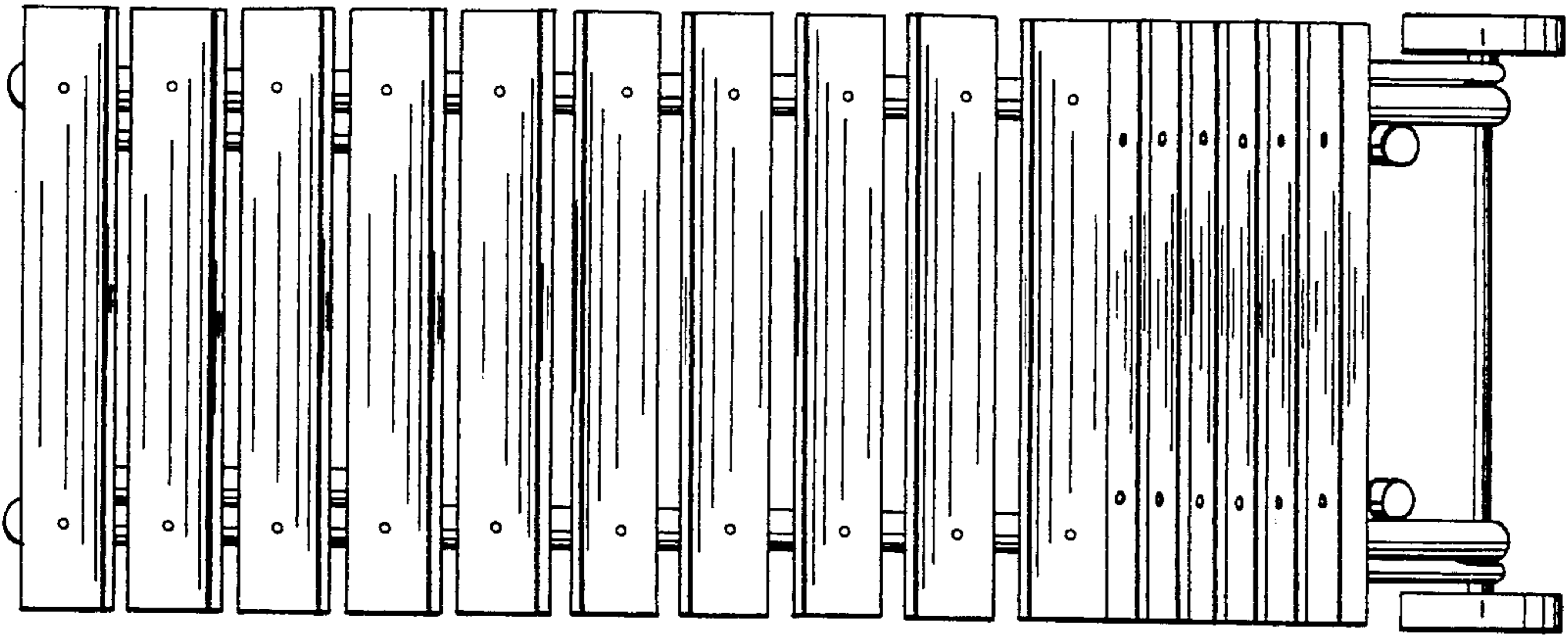




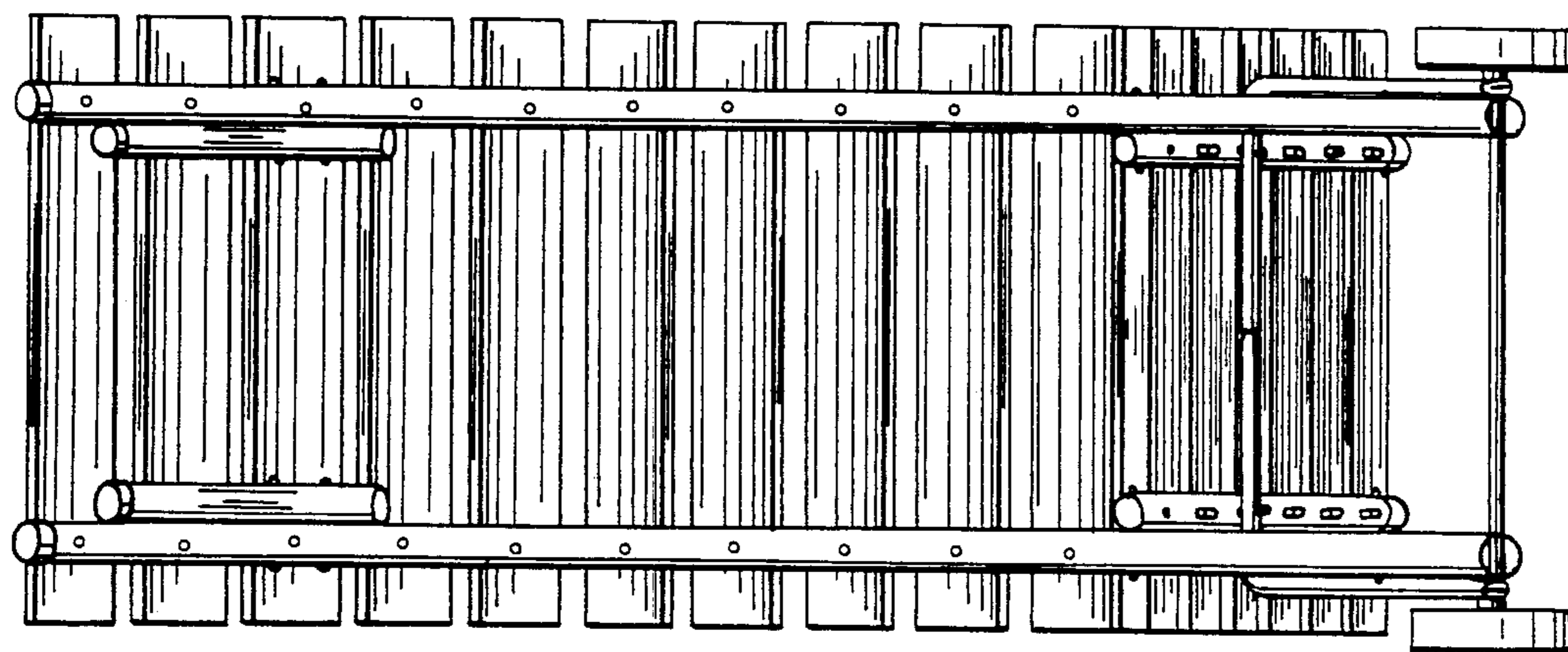
*Fig. 1*



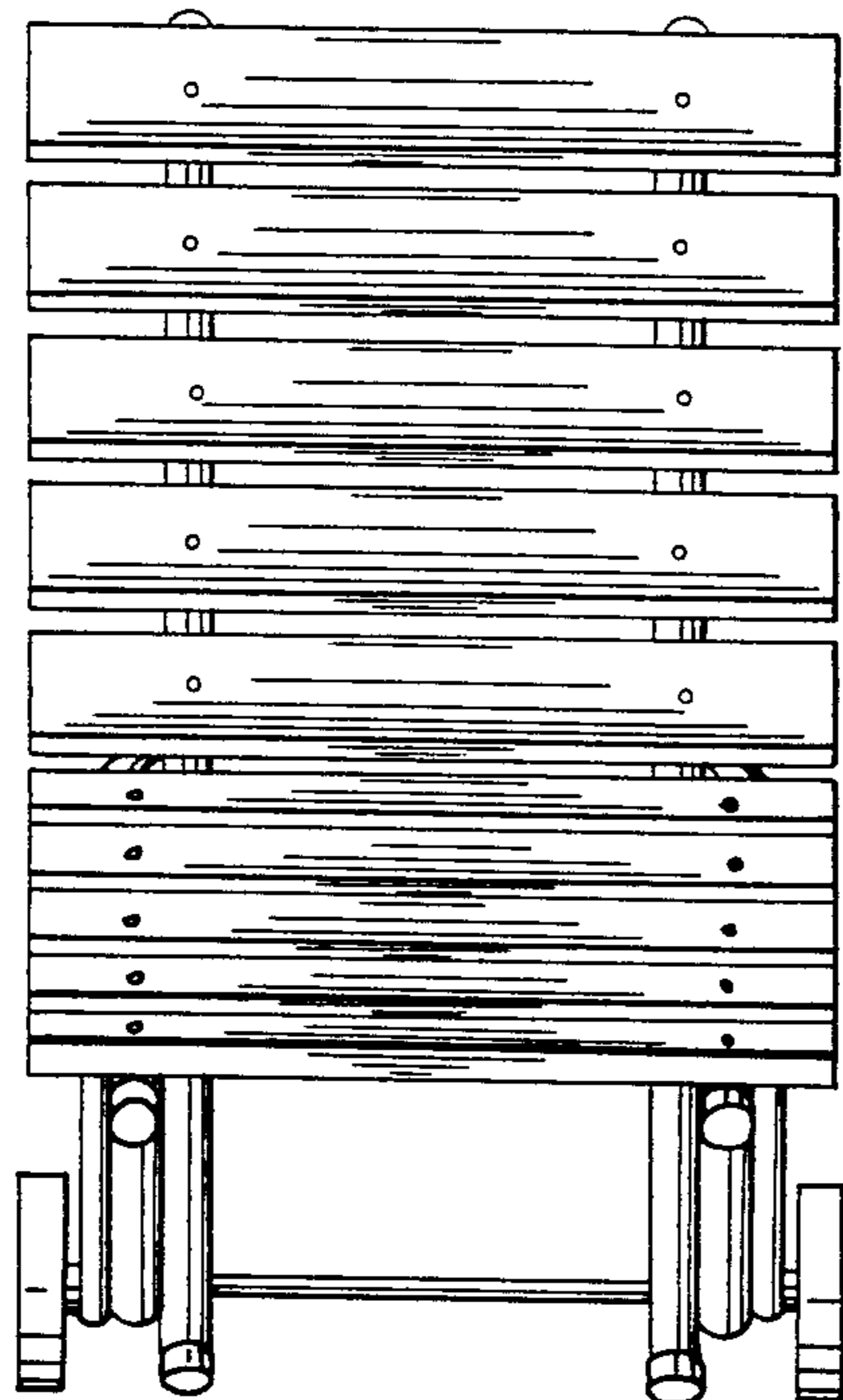
*Fig. 2*



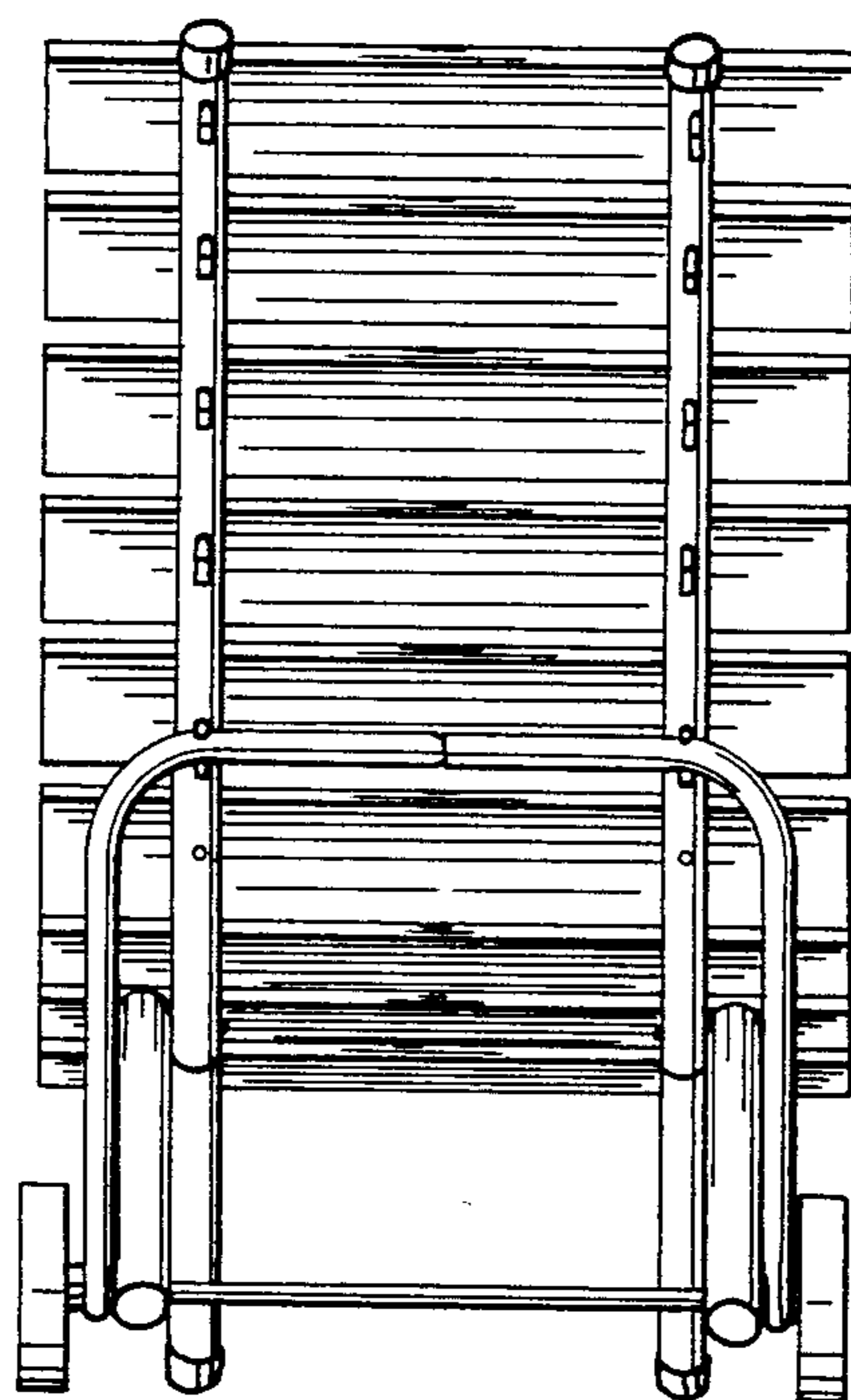
*Fig. 3*



*Fig. 4*



*Fig. 5*



*Fig. 6*