

[54] VEHICLE CONSOLE UNIT

[75] Inventor: James P. Butler, Lewisville, Tex.

[73] Assignee: Affiliated Hatch and Sunroof, Inc., Dallas, Tex.

[**] Term: 14 Years

[21] Appl. No.: 956,077

[22] Filed: Oct. 30, 1978

[51] Int. Cl. D12-16

[52] U.S. Cl. D12/155

[58] Field of Search D12/155; 180/90; 296/37.7, 37.8; 224/311, 42.42, 42.46 R, 324

[56] References Cited

U.S. PATENT DOCUMENTS

- D. 245,414 8/1977 Ashbaugh et al. D12/155
- 4,079,987 3/1978 Bumgardner D12/155

Primary Examiner—James M. Gandy

Attorney, Agent, or Firm—Hubbard, Thurman, Turner, Tucker & Glaser

[57] CLAIM

The ornamental design for a vehicle console unit, as shown and described.

DESCRIPTION

FIG. 1 is a lower front prospective view of a vehicle console unit showing my new design, it being understood that the broken lines are for illustrative purposes only;

FIG. 2 is an enlarged upper front prospective view thereof;

FIG. 3 is an enlarged front elevational view thereof;

FIG. 4 is an enlarged right side elevational view thereof, it being understood that the left side is a mirror image of the right side shown;

FIG. 5 is an enlarged back elevational view thereof;

FIG. 6 is an enlarged top plan view thereof; and

FIG. 7 is an enlarged bottom plan view thereof.

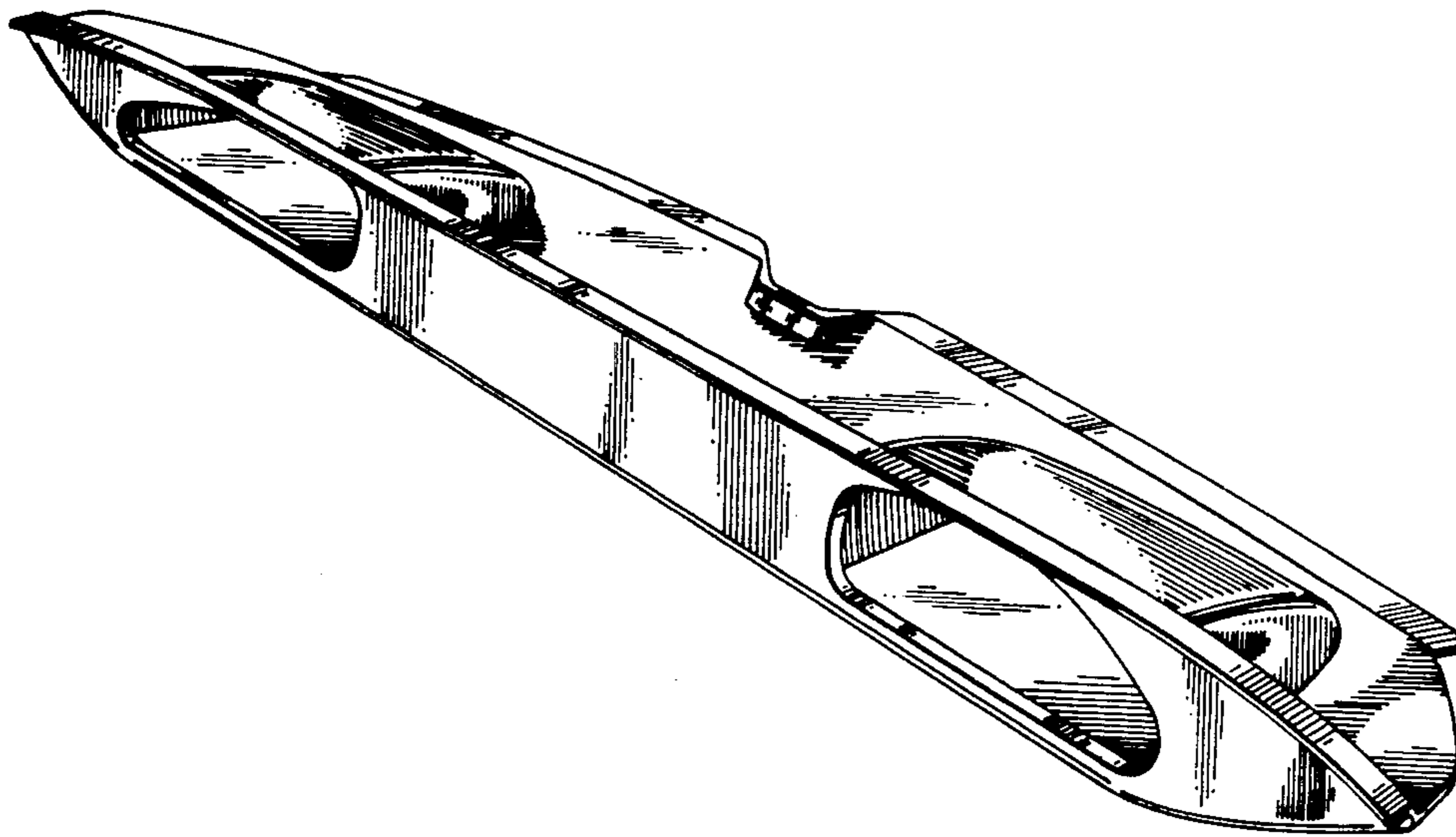

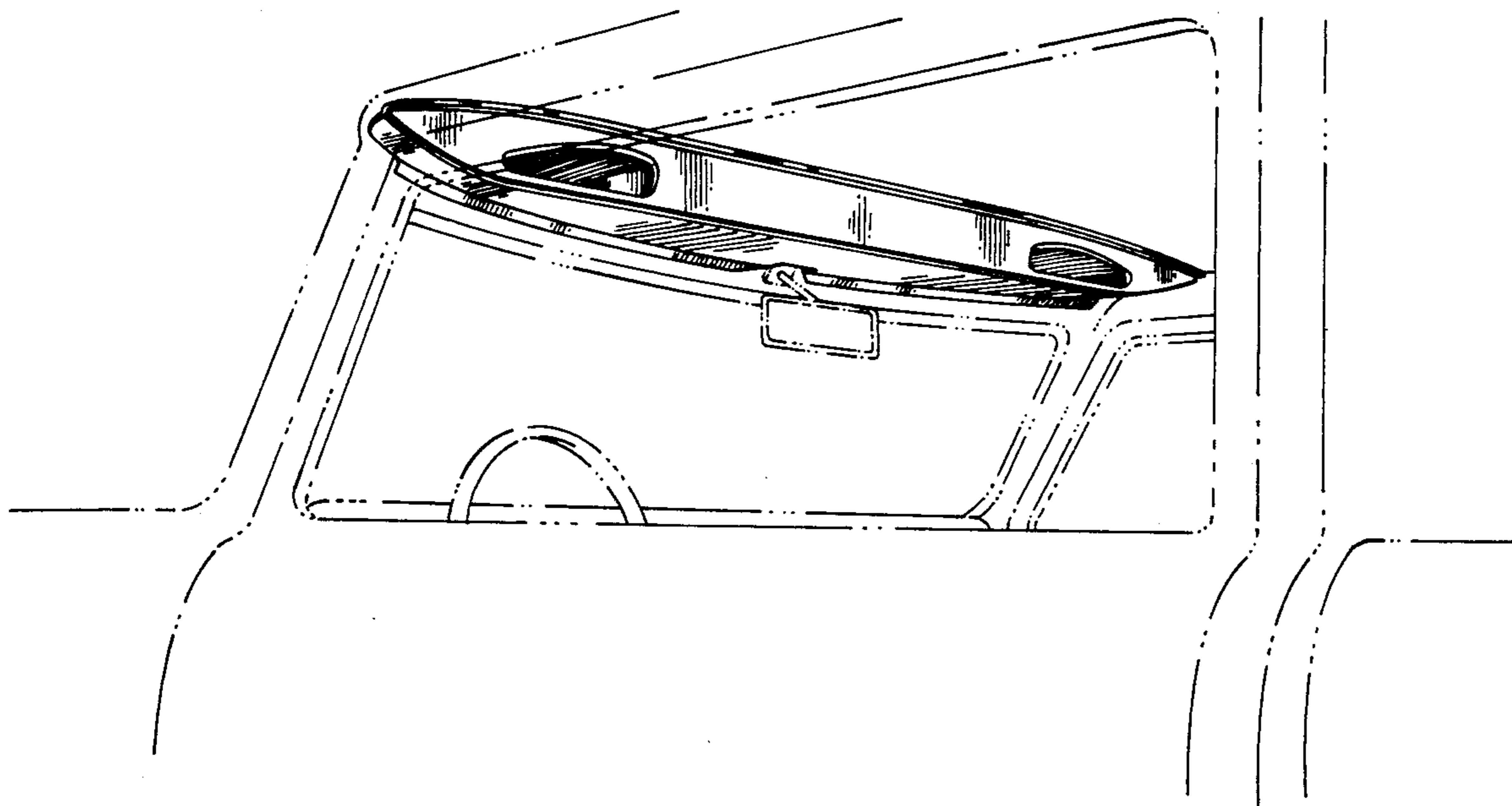

FIG. 1

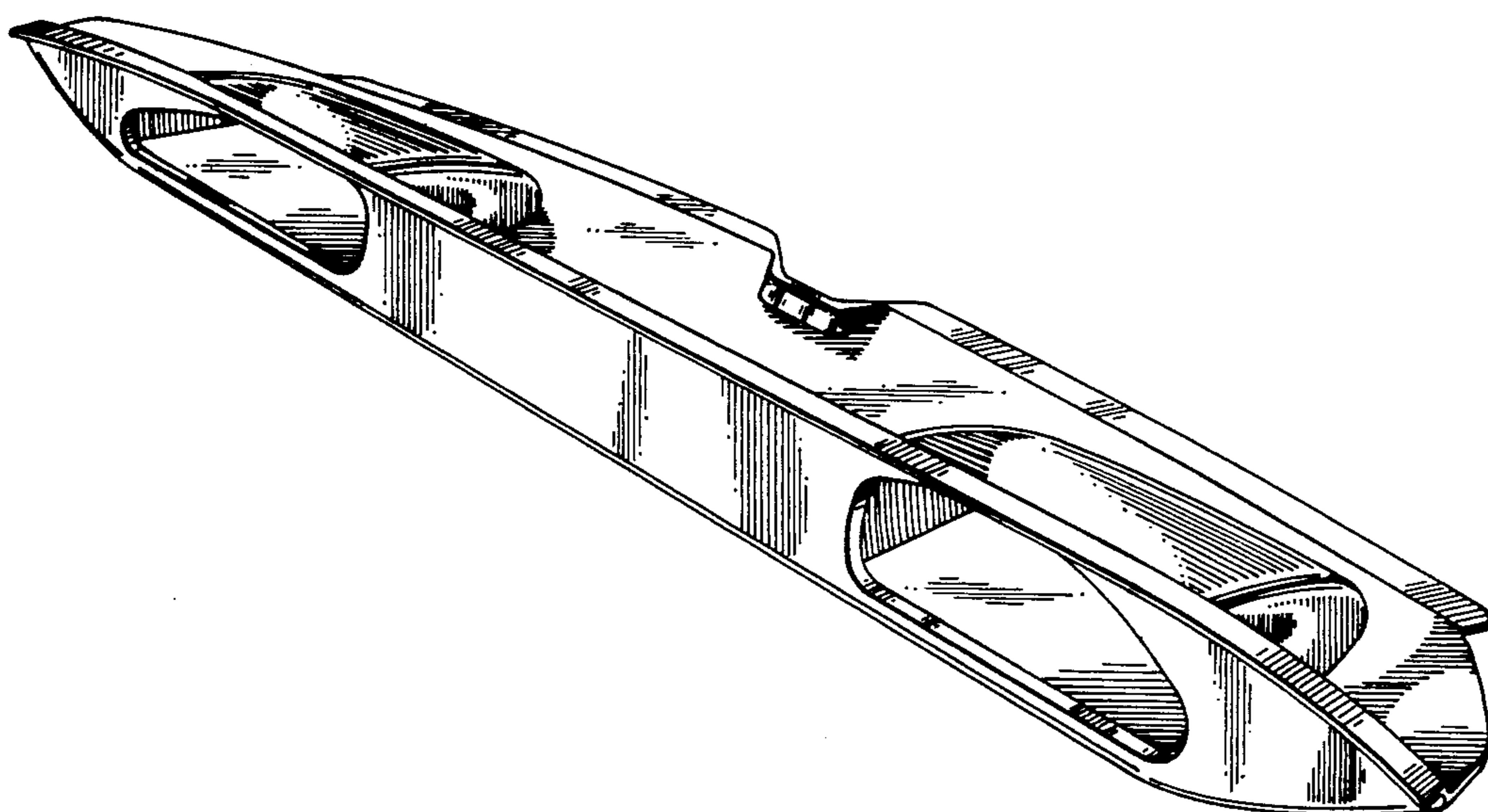

FIG. 2

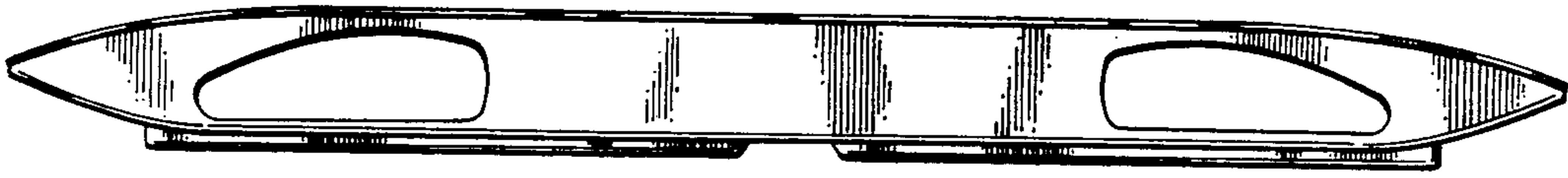

FIG. 3

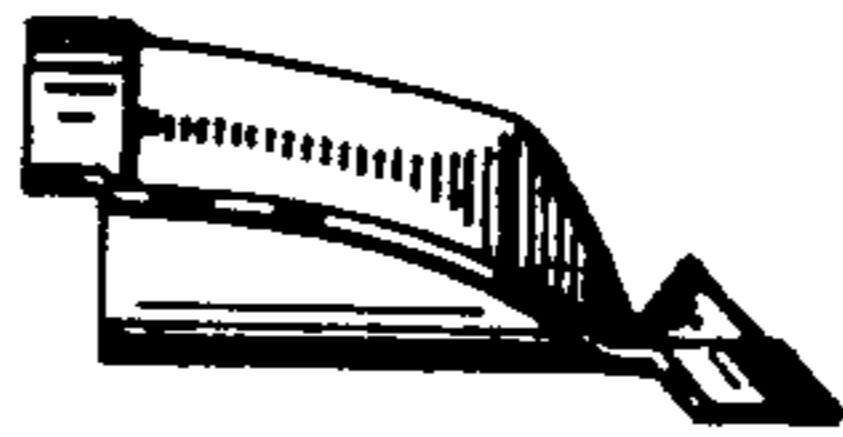

FIG. 4

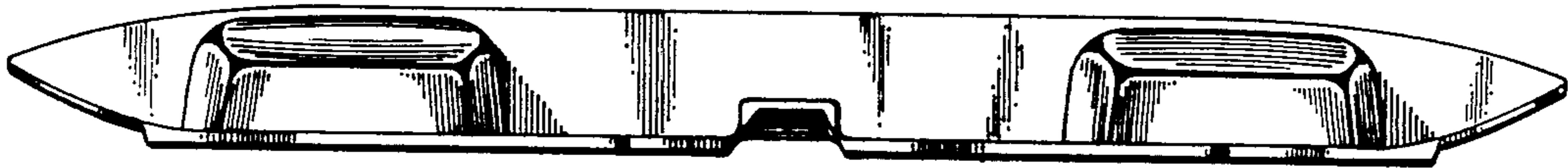

FIG. 5

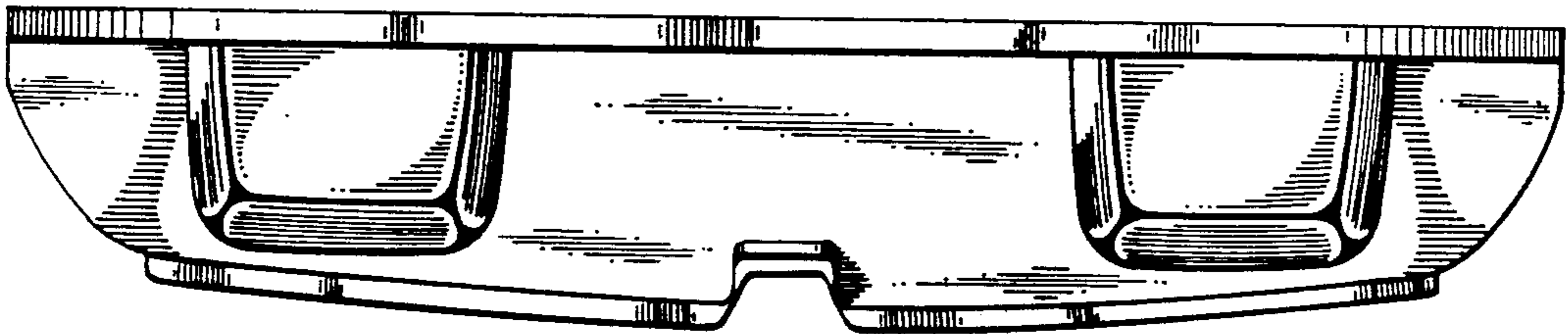

FIG. 6

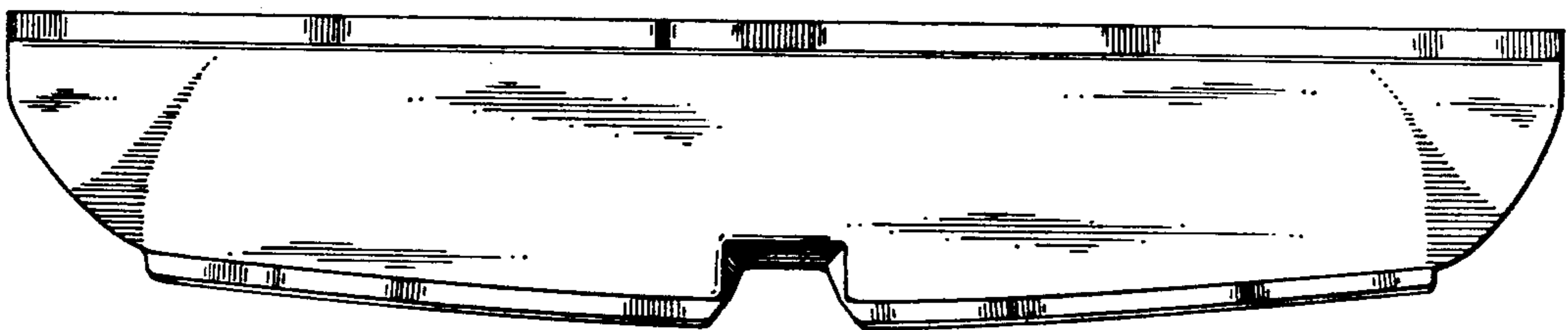

FIG. 7